

QST

november, 1941

25 cents

35c in Canada

devoted entirely to

amateur radio

Carter

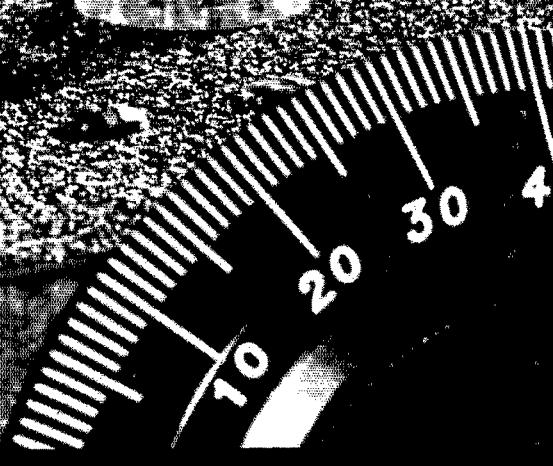

In This Issue - Using the 8100 Series Tubes

More than 100 types of tubes for use in Commercial Broadcasting, Point to Point Communication, Ultra High Frequency Transmission, Electro Medical Apparatus, High Voltage Rectification and many Industrial Applications.



We're in the Army Now*

*U. S. Army, Navy, Civil, and Aeronautical Departments, etc.

. . . and faced with a continuous step-up in the demand for AMPEREX Transmitting and Rectifying Tubes for the armed services.

Despite the fact that your valued commercial orders for certain tube types must be subordinated to problems arising from the national emergency, the priorities situation, restrictions on certain rare refractory metals and materials, etc. . . . we are still able to fill all your orders.

However, in this period of unusual stress, we ask your consideration and cooperation in anticipating your requirements so that we may maintain our customary rapid delivery schedules.

AMPEREX ELECTRONIC PRODUCTS
79 WASHINGTON STREET • BROOKLYN, NEW YORK

ARMY COOKS

Stir up
**GOOD
RECEPTION!**



IN the Army, the Navy, or wherever you are you can stir up good reception with a Hallicrafters Sky Traveler. Here is a portable that has been designed for real communications performance. Nine tubes, 1.4 volt tubes used throughout, 4 bands, covers 550 kc. to 30.5 mc. electrical bandspread, self-contained collapsible antenna extends to nearly 3 feet, battery life prolonged through a self-contained charging circuit,

automatic noise limiter, an RF stage used on all bands, sensitivity below two microvolts on all bands, high gain antenna coupling circuit for maximum antenna energy transfer, permeability tuned RF and IF circuits. The Sky Traveler has all the essential controls, operates on either 110/125 volts AC or DC or from its self-contained batteries. Cabinet dimensions 7" x 8½" x 12¼". Model S-29 The Sky Traveler \$69.50.

the hallicrafters co.
CHICAGO, U. S. A.

USED BY 33 GOVERNMENTS ★ **SOLD IN 89 COUNTRIES**

Enjoy FM at its Best!

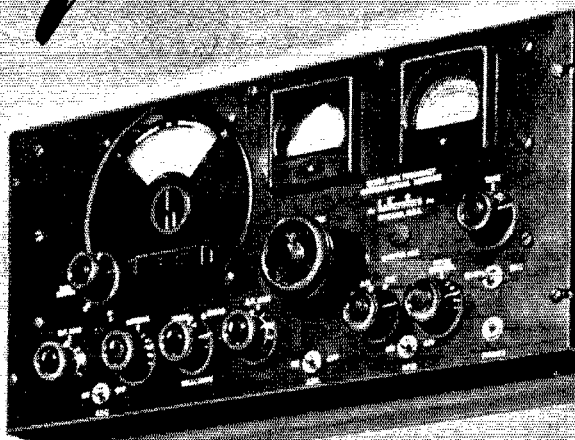

Frequency Modulation and Amplitude Modulation in One Receiver

A FREQUENCY MODULATION communications receiver covering three bands: 28 to 46 mc; 45 to 84 mc; 81 to 145 mc. Switch changing from FM to AM reception. Acorn tubes in RF and converter system. High gain 1852 tubes in Iron Core IF stages. Beam power tubes in AF amplifier. Controls are: RF gain control, Band Switch. Antenna trimmer. IF selectivity control and power switch. Volume control, Pitch control, Tone control, S-Meter adjustment, AVC on-off switch, Send-receive switch, 15 tubes. Operates on 110 volts 50-60 cycle AC. Cabinet dimensions 19" long, 9" high, 14" deep. Model S-27 FM/AM Receiver complete with tubes. \$195. Model S-27B (Covers from 36 to 165 mc.) \$195.

Jensen Model CRJ-52 Reproducer delivers outstanding performance with FM/AM Model S-27 and S-27B

the hallicrafters co.
CHICAGO, U. S. A.

USED BY 33 GOVERNMENTS ★ SOLD IN 89 COUNTRIES

NOVEMBER 1941

VOLUME XXV

NUMBER 11



STAFF

Editorial

KENNETH B. WARNER, W1EH
Editor and Business Manager

CLARK C. RODIMON, W1SE
Managing Editor

GEORGE GRAMMER, W1DF
Technical Editor

DONALD H. MIX, W1TS
BYRON GOODMAN, W1JPE
Assistant Technical Editors

EDWARD P. TILTON, W1HDQ
Contributing Editor, U.H.F.

VERNON CHAMBERS, W1JEQ
Technical Information Service

JAMES J. LAMB, W1AL
Research Engineer, A.R.R.L.

Advertising

F. CHEYNEY BEEKLEY, W1GS
Advertising Manager

Circulation

DAVID H. HOUGHTON
Circulation Manager

RALPH T. BEAUDIN, W1BAW
Asst. Circulation Manager



OFFICES

38 La Salle Road
West Hartford, Connecticut

Subscription rate in United States and Possessions, \$2.50 per year, postpaid; all other countries, \$3.00 per year, postpaid. Single copies, 25 cents. Foreign remittances should be by international postal or express money order or bank draft negotiable in the U. S. and for an equivalent amount in U. S. funds.

Entered as second-class matter May 29, 1919, at the post office at Hartford, Connecticut, under the Act of March 3, 1879. Acceptance for mailing at special rate of postage provided for in section 1103, Act of October 3, 1917, authorized September 9, 1922. Additional entry at Concord, N. H., authorized February 21, 1929, under the Act of February 28, 1925. Additional second-class entries to cover sectional editions authorized March 20, 1935.

Copyright 1941 by the American Radio Relay League, Inc. Title registered at United States Patent Office.

QST

devoted entirely to

AMATEUR RADIO

PUBLISHED MONTHLY, AS ITS OFFICIAL ORGAN, BY THE AMERICAN RADIO RELAY LEAGUE, INC., AT WEST HARTFORD, CONN., U. S. A.; OFFICIAL ORGAN OF THE INTERNATIONAL AMATEUR RADIO UNION



CONTENTS

Editorials	7
Two U.H.F. Receivers Using the 9000 Series Tubes <i>Byron Goodman, W1JPE</i>	10
A Coupling Unit for Continuous Rotation <i>Ellery L. Plotts, W9WJP</i>	15
U. S. Antarctic Service Expresses Appreciation For the Junior Constructor	17
An Antenna Tuner for the Beginner	18
What the League Is Doing	21
A Soldier's Portable <i>Glenn Roof, W8OPG</i>	22
A Low-C Electron-Coupled Oscillator <i>E. O. Seiler, W3PK</i>	26
U. S. A. Calling	28
More Meaning in Your Signal Reports <i>S. Gordon Taylor, W2JCR</i>	30
Warning!	33
In the Services	34
A Mobile Transmitter for 2½ Meters <i>Vernon Chambers, W1JEQ</i>	36
Texas Hurricane Finds Hams Ready	39
On the Ultra Highs <i>E. P. Tilton, W1HDQ</i>	40
U.H.F. Roundup	43
Vibrator Power Supplies <i>Byron Goodman, W1JPE</i>	44
The 12th ARRL Sweepstakes <i>F. E. Handy, W1BDI</i>	47
QST, 25 Years Ago this Month	49
I.A.R.U. News	50
Army-Amateur Radio System Activities	51
Hints and Kinks <i>Working the 80-Meter Zepp on 160 — Resistance Capacity Audio Oscillator for Monitoring Keying — A Multiband End- Fed Antenna — Cheap Filament Rheostat — Variable Crystal Frequency with Locked Oscillator — Boosting Transformer Voltage — Improved Voltage Regulation for the Oscillator</i>	52
Correspondence from Members	55
Operating News	56
Trainee Traffic Flash	59
Brass Pounders' League	59
ARRL Official Broadcasting Stations	60
W1AW Practice Subjects and Qualifying Runs	60
Eighth UHF Contest and Relay Scores	60
Pacific Division Convention	72
Code Proficiency Runs	72
Silent Keys	74
ARRL Affiliated Club Honor Roll	90
WVW Schedules	90
New Apparatus	100
Hamads	107
QST's Index of Advertisers	110

Section Communications Managers of the A.R.R.L. Communications Department

All appointments in the League's field organization are made by the proper S.C.M., elected by members in each Section listed. Mail your S.C.M. (on the 16th of each month) a postal covering your radio activities for the previous 30 days. Tell him your DX, plans for experimenting, results in phone and traffic. He is interested, whether you are an A.R.R.L. member or get your QST at the newsstands; he wants a report from every active ham. If interested and qualified for O.R.S., O.P.S. or other appointments he can tell you about them, too.

ATLANTIC DIVISION				
Eastern Pennsylvania Maryland-Delaware-District of Columbia Southern New Jersey Western New York Western Pennsylvania	W3BES W3CIZ W3CCO W8PLA W8CKO	Jerry Mathis Hermann E. Hobbs Lester H. Allen Fred Chichester E. A. Krall	6042 Master St. 9701 Monroe St. Silver Spring P. O. 704 Quinton Ave. 703 Broadway	Philadelphia Linden, Maryland Trenton Sowea East McKeesport
CENTRAL DIVISION				
Illinois Indiana Kentucky Michigan Ohio Wisconsin	W9ILH W9AB W9ARU W8DPE W8AQ W9UIT	Mrs. Carrie Jones Harry B. Miller Darrell A. Downard Harold C. Bird E. H. Gibbs Aldrich C. Krones	2407 Central Ave. 729 E. Lowell Ave. 116 N. Longworth Ave. R.F.D. 2 405 Broad St. 2702 So. 46th St.	Alton Mishawaka Louisville Pontiac Warsworth Milwaukee
DAKOTA DIVISION				
North Dakota South Dakota Northern Minnesota Southern Minnesota	W9RPI W9ADJ W9FUJ W9YVQ	Don Beaudine E. C. Mohr Armond D. Brattland Millard L. Bender	512 14th St. S. Box 149 Birchmont Rd. 608 N. Huron Ave.	Fargo Rapid City Bemidji Spring Valley
DELTA DIVISION				
Arkansas Louisiana Mississippi Tennessee	W5GNV W5DWW W5EGE W4DDJ	John R. Sanders W. J. Wilkinson, Jr. S. Benton Cain M. G. Hooper	P. O. Box 1563 Room 313, Jefferson Hotel 221 E. Monticello 4908 Georgia Ave.	Little Rock Shreveport Brookhaven Nashville
HUDSON DIVISION				
Eastern New York N. Y. C. & Long Island Northern New Jersey	W2LIJ W2AZV W2LMN	Robert E. Haight E. L. Baunach Edward Gursky, Jr.	511 South Holmes St. 102 Central Ave. 367 Van Winkle Ave.	Scotia Massapequa, L. I. Hawthorne
MIDWEST DIVISION				
Iowa Kansas Missouri Nebraska	W9CTO W9AWP W9QMD W9WKP	Ray I. Martin A. C. Unruh Robert E. Morwood Garold Bennett	209 Leifer St. 1617 S. Seneca St. 616 Delmar 914 West 7th St.	West Burlington Wichita Springfield Hastings
NEW ENGLAND DIVISION				
Connecticut Maine Eastern Massachusetts Western Massachusetts New Hampshire Rhode Island Vermont	W1CTI W1BAV W1ALP W1AFH W1FTI W1HRC W1KJG	Frederick Ells, Jr. Ames R. Millett Frank L. Baker, Jr. William L. Barrett Mrs. Dorothy W. Evans Clayton C. Gordon Clifton G. Parker	19 Merrill Rd. 37 Morning St. 91 Atlantic St. 239 Columbia St. P. O. Box 312 70 Columbia Ave., Gaspee Box 537	Norwalk Portland North Quincy Adams Concord Plateau, Warwick Morrisville
NORTHWESTERN DIVISION				
Alaska Idaho Montana Oregon Washington	K7GNN W7CRL W7CPY W7GNI W7EPB	James G. Sherry Clifford A. Jessup Rex Roberts Carl Austin Carl F. Hofmann	Post Office Dept. Box 1038 1137 Federal 4413 East E St.	Chichagof Moscow Glendive Bend Tacoma
PACIFIC DIVISION				
Hawaii Nevada Santa Clara Valley East Bay San Francisco Sacramento Valley Philippines San Joaquin Valley *	K6ETF W6BIC W6LIZ W6TTI W6CIS W6MDI KA1GR W6PPO	Francis T. Blatt Edward W. Heim Earl F. Sanderson Horace R. Greer Kenneth E. Hughes Vincent N. Feldhausen George L. Rickard H. S. Walling	837 16th Ave. 509 Claremont St. 101 Claremont Ave. 414 Fairmount Ave. 200 Naylor St. 113 South Quincy St. Box 849 Box 929	Honolulu Reno San Jose Oakland San Francisco McCloud Manila Fresno
ROANOKE DIVISION				
North Carolina South Carolina Virginia West Virginia	W4CYB W4BOE/ANG W4GWQ W8XOQ	W. J. Wortman Ted Ferguson Frank S. Anderson, Jr. W. D. Tabler	P. O. Box 566 1213 College St. 4703 New Kent Ave. 1004 So. Davis Ave.	Morganton Columbia Richmond Elkins
ROCKY MOUNTAIN DIVISION				
Colorado Utah-Wyoming	W9EHC W7GZG	Carl C. Drumeller Henry L. Schroeder	606 E. 6th St. P. O. Box 731	Pueblo, Colorado Laramie, Wyoming
SOUTHEASTERN DIVISION				
Alabama Eastern Florida Western Florida Georgia West Indies (Cuba) (Puerto Rico-Virgin Islands)	W4DGS W4PEI W4AXP W4AOB CM2OP K4KD	James F. Thompson Carl G. Schaal Oscar Cederstrom William U. Hanks Mario de la Torre Everett Mayer	12 Clanton Ave. Waucoma Apts. Lakeview Hotel Second St. & Bruce Ave. 4 Hunter St., S.E. Escobar 110 (Altos) 24 Lindbergh St.,	Montgomery Clermont De Funiak Springs Atlanta Habana, Cuba Santurce, P. R.
SOUTHWESTERN DIVISION				
Los Angeles Arizona San Diego	W6MQM W6KOL W6BKZ	Ralph S. Click John K. Oliver Louis A. Cartwright	1038 Milwaukee Ave. Box 642 7214 Fay St.	Los Angeles Napa La Jolla
WEST GULF DIVISION				
Northern Texas * Oklahoma Southern Texas New Mexico	W5EAV W5GFT W5MNI W5ENI	R. E. Hughes Russell W. Battern Horace E. Bidy Dr. Hilton W. Gillett	1410 Ave. E, N.W. Box 290 1746 Sealey Ave.	Childress Enid San Antonio Lovington
MARITIME DIVISION				
Maritime	VE1DQ	A. M. Crowell	69 Dublin St.	Halifax, N. S.
ONTARIO DIVISION				
Ontario	VE3EF	Flying Officer Donald R. Gunn	% Canadian Bank of Commerce	New Toronto, Ont.
QUEBEC DIVISION				
Quebec	VE2CO	Lindsay G. Morris	Apt. 6, 4510 Girouard Ave., N.D.G.	Montreal, P. Q.
VANALTA DIVISION				
Alberta British Columbia	VE4GE VE5DD	C. S. Jamieson C. O. I. Sawyer	581 W. Riverside Drive 2634 West 31st Ave.	Drumheiler, Alta. Vancouver
PRAIRIE DIVISION				
Manitoba Saskatchewan	VE4AAW VE4SY	A. W. Morley Arthur Chesworth	747 McMillan Ave. 1071 4th Ave., N.W.	Winnipeg Moose Jaw

* Officials appointed to act until the membership of the Section choose permanent S.C.M.s by nomination and election.

If You Want the Best

We Recommend these new "Coaxial" Speakers

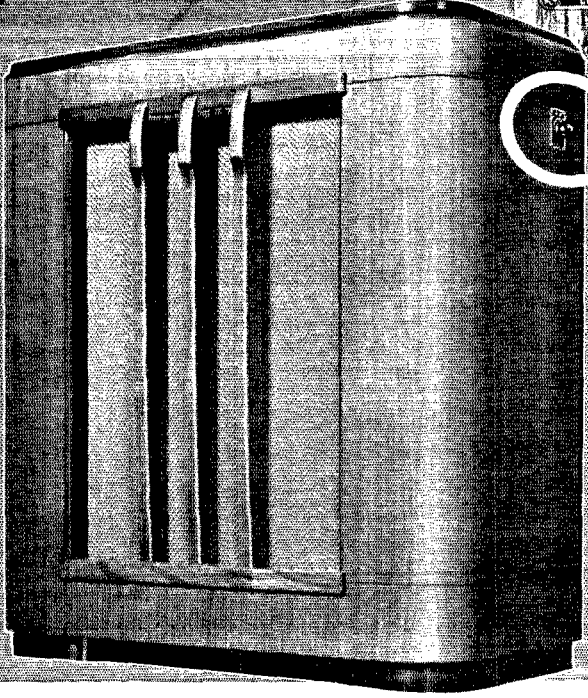
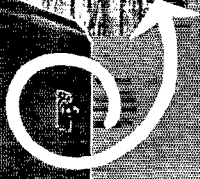
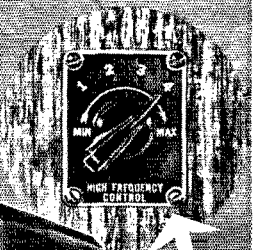

Most versatile reproducer for home club or institution. Features full realization of the potentialities of the fine FM or AM receivers.



Excellent "across-the-room" unit for casual, more enjoyable reproduction with chairside tuners and combinations.



Recommended by manufacturers of professional type FM/AM receivers. Be sure you can enjoy FM at its best!

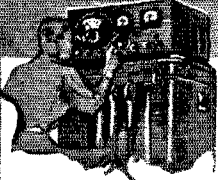

Brilliant Performance plus Complete Versatility with these New Jensen "Coaxial" Speakers

Not one—but two important achievements are combined in these new Jensen Coaxial Speakers and Reproducers! First...extended-range high-fidelity performance that meets the most critical professional requirements. Second...complete versatility, made possible for the first time by the new Jensen High Frequency Control. Now one reproducer covers every listening requirement, instantly adjustable for most satisfactory results on everything from wide range FM to home phono records! And the cost is so low it will surprise you. Data Sheet No. 120 gives complete details. Write for it today.

Four complete reproducer types with 12" to 15" speaker sizes, priced at \$75.25 to \$118.75 list in striped walnut cabinets. Utility cabinet models down to \$64.25 list. Coaxial speakers only as low as \$29.50 list.



Smooth, extended-range high-fidelity response eminently qualifies these reproducers for the most exacting service in FM/AM broadcast and recording monitoring.

Jensen

JENSEN RADIO MFG. CO., 6601 S. LARAMIE AVE., CHICAGO
CABLE ADDRESS: "JERRAD" CHICAGO



THE AMERICAN RADIO RELAY LEAGUE

Directors

<i>President</i>	
GEORGE W. BAILEY	W1KH
74 Webster Road, Weston, Mass.	
<i>Vice-President</i>	
CHARLES E. BLALACK	W6GG
Box 55, Yuma, Ariz.	
<i>Canadian General Manager</i>	
ALEX. REID	VE2BE
240 Logan Ave., St. Lambert, P. Q.	
<i>Atlantic Division</i>	
WALTER BRADLEY MARTIN	W3QV
Box 612, Roslyn, Pa.	
<i>Central Division</i>	
GOODWIN L. DOSLAND	W9TSN
10 No. Clark St., Chicago	
<i>Dakota Division (Acting)</i>	
ADOLPHUS A. EMERSON	W9ITQ
5336 S. Elliott Ave., Minneapolis	
<i>Delta Division</i>	
E. RAY ARLEDGE	W5SI
P.O. Box 236, Pine Bluff, Ark.	
<i>Hudson Division</i>	
ROBERT AKERIDGE KIRKMAN	W2DSY
920 Eighth Ave., Brooklyn	
<i>Midwest Division</i>	
FLOYD E. NORWINE, JR.	W9EFC
7405 Hiawatha Ave., Richmond Heights, Mo.	
<i>New England Division</i>	
PERCY C. NOBLE	W1BVR
37 Broad St., Westfield, Mass.	
<i>Northwestern Division</i>	
KARL W. WEINGARTEN	W7BG
3219 N. 24th St., Tacoma, Wash.	
<i>Pacific Division</i>	
J. L. McCARGAE	W6EY
66 Hamilton Pl., Oakland, Calif.	
<i>Ronoke Division</i>	
H. L. CAVENESS	W4DW
2607 Vanderbilt Ave., Raleigh, N. C.	
<i>Rocky Mountain Division</i>	
C. RAYMOND STEDMAN	W9CAA
925 So. Gaylord St., Denver	
<i>Southeastern Division</i>	
WILLIAM C. SHELTON	W4ASR
Box 652, Daytona Beach, Fla.	
<i>Southwestern Division</i>	
JOHN E. BICKEL	W6BKY
801 E. California St., Whittier, Calif.	
<i>West Gulf Division (Acting)</i>	
W. T. CABWELL, JR.	W5BB
1502 West Ave., Austin, Texas	

THE AMERICAN RADIO RELAY LEAGUE, INC., is a non-commercial association of interest in amateur radio communication and experimentation, for the relaying of messages by radio, for the advancement of the radio art and of the public welfare, for the representation of the radio amateur in legislative matters, and for the maintenance of fraternalism and a high standard of conduct.

It is an incorporated association without capital stock, chartered under the laws of Connecticut. Its affairs are governed by a Board of Directors, elected every two years by the general membership. The officers are elected or appointed by the Directors. The League is non-commercial and no one commercially engaged in the manufacture, sale or rental of radio apparatus is eligible to membership on its board.

"Of, by and for the amateur," it numbers within its ranks practically every worth-while amateur in the nation and has a history of glorious achievement as the standard-bearer in amateur affairs.

Inquiries regarding membership are solicited. A bona fide interest in amateur radio is the only essential qualification; ownership of a transmitting station and knowledge of the code are not prerequisite. Correspondence should be addressed to the Secretary.



Past Presidents

HIRAM PERCY MAXIM, W1AW, 1914-1936
EUGENE C. WOODRUFF, W8CMP, 1936-1940

Officers

<i>President</i>	GEORGE W. BAILEY, W1KH
	Weston, Mass.
<i>Vice-President</i>	CHARLES E. BLALACK, W6GG
	Yuma, Ariz.
<i>Secretary</i>	KENNETH B. WARNER, W1EH
	West Hartford, Connecticut
<i>Communications Manager</i>	F. EDWARD HANDY, W1BDI
	West Hartford, Connecticut
<i>Acting Treasurer</i>	DAVID H. HOUGHTON
	West Hartford, Connecticut

General Counsel PAUL M. SEGAL
1026 Woodward Building, Washington, D. C.

Address all general correspondence to the administrative headquarters at West Hartford, Connecticut.

"IT SEEMS TO US—"

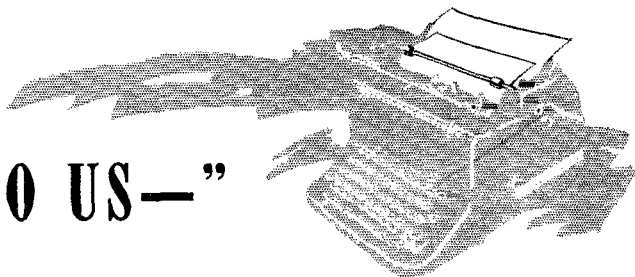

THE AMATEUR AND NATIONAL DEFENSE

FOR a great many months we have been passing on to you fellows the word we got to QRX on defense communications activities until plans were officially approved and jobs assigned us. Nothing has happened. We are tired of waiting and we cannot any longer make ourselves believe that it is in the interests either of ourselves or of the country to keep on waiting. It seems to us that the time has come for us, of our own initiative, to reorganize our communications in terms of the most intelligent approximation of defense needs that we can make, without waiting any longer for blessings, requests or green lights from anybody.

The delay has been understandable but not reassuring. There is, everywhere, a plague of "paper-work" of the damndest proportions conceivable; things get lost in it. Too, the work has seemed academic: bombings and invasion are remote. Again, Washington has been plagued to death by "coöperators," people who want to organize something for the government and who are driving harassed officials nuts in the process. Finally, there's sometimes a hide-bound inflexibility of attitude: that if a thing is unorthodox or not to be found in the rule-book, it isn't any good. The net result of these things is that they make for the gradual elimination, one after the other, of communication tasks once contemplated for the amateur or for which we had hopes because we visualized how neatly we could do the job, and for the postponement of action on the others. Naturally we are restless, since we know that it takes a long time to plan a communications job, select and appoint the stations for it and drill it to satisfactory proficiency. We also know from experience that we amateurs, in any such undertaking, will inevitably evolve new tactics and short-cut procedures, and that such a program of development again takes time. We growl whenever we think of the precious months that have already been lost through no fault of our own; they were suf-

ficient to have perfected our organization. We become even more impatient when we look around ourselves and realize that, through no lack of eagerness or ability, we have been worked into a position where critics who weren't too scrupulous or well-informed could say that we aren't doing much of national-defense value beyond our inherent "reservoir" and "training school" qualities and our value for disaster-relief jobs. The League cannot accept this situation. We've decided to go ahead on our own.

WE'VE been doing a lot of thinking at Headquarters about this subject. One thing that quickly becomes apparent is that it is essentially a job of rearranging our communication activities rather than of creating vast additional ones. What it sums up to is a shift of emphasis during the time our services are needed for defense.

We look forward now to a gradual decrease in the kinds of activities to which we have been accustomed and the steady conversion of our operating time and energies to projects having more national-defense value. Probably we'll have fewer contests and "parties," for one thing. Amateurs with limited operating time in many cases will drop out of their old activities to devote themselves to something that has the appeal of greater importance. We foresee this as meaning, in a great many cases, their reappearance in a different part of the spectrum where they're more needed. The job of the League will be to make plans, offer opportunities and provide direction as we steadily shift our aim to new objectives.

Let us at this point examine the possibilities and determine what are the fields in which we are needed and in which we can do a good job. From that we can establish what must be the nature of this change of emphasis.

We suppose that, to many members, the thought of the amateur in national defense will immediately imply some sort of direct collaboration with the military forces. This is not correct. The Army is manned and equipped to do its own communicating job, on its own frequencies. If we want to partici-

pate in that effort we ought to enlist or accept commissions in the Army. It does not need or want our collaboration as amateurs. Even the thoughts we had been encouraged to hold about our participation in the aircraft warning service have been emptied by recent developments in the technique for dealing with that subject — it will be essentially a wire job, and necessarily so. Only in that kind of dire emergency which we trust will never come can we expect the Army to want, or be willing to accept, any assistance from us. (At that, though, we ought to carry constantly in the back of our heads the need to maintain facilities of such nature that they are adequate for that task if called upon; we have reason to believe that there are several places where the map of Europe to-day would be somewhat different if a few good amateur stations had been in commission.)

No, our field is not the military. We are civilians. Our ARRL is a civilian organization. We live the lives of civilians, we're at home in that atmosphere, we know our way around our own communities. All our traditions inculcate in us a sense of responsibility to our civil communities. Our long experience in disaster-relief communication has been in that field. It is a natural for us, and it does need our assistance and is asking for it. We can do that job well because we fit into it by nature. That is our primary field in the defense picture: civilian defense.

Civilian protection is being organized by a federal agency called the United States Office of Civilian Defense, commonly known as OCD. Under its organization plan a state defense group operates in each state through a state coördinator under the governor. In each city the vital activities are directed from a control center bossed by a local defense coördinator, who is the executive officer of the mayor and of a civilian defense committee. OCD's local functions include such things as firefighting, police, medical facilities, public works, utilities, the maintenance of vital services. It enrolls voluntary personnel to engage in such fields as auxiliary fire protection, auxiliary police, blackouts, air wardens, bomb removal, first aid, care of casualties, sanitation, shelters, rescue, welfare, evacuation. You can learn much about it by obtaining a copy of the booklet, "Local Organization for Civilian Protection," from the nearest OCD office. The state organizations seem to be less standardized; they depend upon the needs.

The functioning of these OCD organizations — state and local — is of course utterly dependent upon communication. Normally they will depend upon wires. But the very circumstances that bring the organization into play

are likely to take the wires out completely or to give them a vast overload, and of course wires don't provide for mobile or portable operation. There is radio's place and right there is where the amateur fits. While the state and county communication plans involving the use of amateur radio were being criticized a few months ago because they followed no government-approved and nationally-uniform plan that guaranteed their ability to function under war-time conditions, we gather that the present official tendency is to encourage the tailoring of plans to fit local situations, using whatever frequencies are most conveniently available. This is all to the good. It overcomes the terrific QRM problem inherent in any nationally-uniform scheme of restricted frequencies. And in it lie the greatest potentialities for preserving our kind of amateur radio. With enough such plans in existence and organized for important tasks, we gain strength and support for the maintenance of the normal amateur structure.

We'll come back to OCD in a moment. But by now we can block in the major outlines of our own structure as it ought to be revamped for the duration of the emergency. We can see that the chief items in it are these:

- 1) Auxiliary communication for Governors' Defense Councils and statewide OCD plans — on our usual traffic frequencies.
- 2) Communication for the OCD local organizations for civilian protection — exclusively on u.h.f.
- 3) Maintenance of our preparedness for emergency communication in times of natural disaster — which will be no respectors of military emergency — a job which is always primarily ours.
- 4) Trunklines and associated state nets, possibly at reduced dimensions, devoted chiefly to trainee traffic and to interstate or longer-haul traffic of an OCD nature.
- 5) That idea we're going to keep in the back of our heads about stand-by arrangements for a military emergency.

BECAUSE wires can go out, the state defense councils need parallel channels via amateur radio to insure contact in those activities which are peculiarly the state's. There must be communication between the capital and those cities where armories or units of the State Guard are located. The state police, even though equipped with radio, may lose its facilities or find them overtaxed at a time when special reliance is put on them. A parallel system connecting its headquarters city with the towns where its outlying barracks and stations are located is indicated. The same thing holds true of the other centers

where the state has activities concerned with medical services, hospitals, public health, evacuation, examination of water supplies, control of forest fires, and so on. One or more amateur traffic nets can do this job in each state. It is a kind of service with which we have long familiarity. In many states this work is already well under way and in many others it is now being planned.

The municipal or local plans need amateur radio even more. Only radio can give satisfactory communication with moving vehicles or roving parties. And it has been England's experience that wires and telephone exchanges within a city go out under bombardment about in proportion to the desperateness of the need for them. This is a u.h.f. job — moreover, a 2½-meter job and generally not a 5-meter one — for several reasons: to restrain the QRM range and minimize intercity interference; to simplify the antenna problem; to afford communication with mobile and readily-portable units. The use of u.h.f. would also be possible in a military situation that forbade the use of lower frequencies. What is needed is amateurs who will supply their apparatus and their services at the needed points of communication and who will join into groups to maintain twenty-four-hour service at these points when need arises. Plans will vary in each community, depending upon the needs, the other facilities available, the number of amateurs. But every city will need a master station located at its control center and maintaining constant communication with similar stations in surrounding towns, reminiscent of our old "five-point" system. Every plan will need a master network to tie the control center to police and fire headquarters, the Red Cross, the mayor's office, the hospitals, etc. In many cities interior networks within the police and fire departments will be desirable, even though these departments have their own radio services, since they will be greatly expanded by volunteer auxiliaries having special duties. Portable or mobile gear will be wanted to accompany fire marshals to large fires, to assist the special police in their guarding of key points. The utilities will need one or more special nets, with a tie-in with the control center, to keep them in touch with their dams, reservoirs, cable crossings, auxiliary stations, etc. There might well be an all-amateur alert net for rooftop fire spotting. There surely ought to be at the control center a pool of lightweight portable apparatus and hams to man it, available for dispatch to particular jobs, including accompanying rescue squads.

It now appears that it was the imminence of this organizing that caused the Chief Signal Officer of the Army to tip us off a few months

back that amateurs would be well advised to possess themselves of "self-powered" movable 2½-meter gear. We have a goodly-sized u.h.f. crew in this country and lately it has been growing by leaps and bounds. But it isn't nearly big enough for this job: we need u.h.f. apparatus in the hands of many more than the limited number of hams who specialize in the ultra highs. We think that *every* amateur now owes it to his community, to amateur radio and to himself to build or acquire u.h.f. apparatus. You of the Old Guard, you brass-pounders who haven't been off of 80 meters the past fifteen years, we mean you too! — as an adjunct to your l.f. station. It's your community, isn't it? You live there and want to help protect it, don't you? It takes u.h.f. apparatus to do it, so you've got to get it. The amateur literature is filled with designs and specifications. They keep coming right along in *QST* and there are more in the new *Handbook*. But we're doing more than that: our technical staff is at work now on a design for apparatus especially planned for the OCD work and we aim to present it very soon in *QST*. We hope to come out with something that can be a recommended ARRL standard, so that thousands of identical rigs can be built all over the country — interchangeable units, familiar to every amateur. It is a tough assignment and we don't know how successful we'll be, because the gear must be inexpensive, made of components easily available and easily replaceable, sufficiently simple to be within the capabilities of the non-u.h.f. man and the fellow who hasn't built much apparatus, able to run both on city juice while that is available and thereafter on its own steam, with a sufficiently stable transmitter and a nonradiating receiver. A nice one-year development project for six men in a commercial laboratory! We aspire to give you something on it in a month or two. But you shouldn't wait for that; we may not succeed. You ought to get going on something now — and not a transceiver, either!

As a practical matter, how do we go about organizing ourselves for this work? Let's look at the two branches separately:

State. Some states have already started, have appointed competent amateurs to head up the show. They are seeking enrollments. In other states the League is asking its Section Communications Managers to assume the liaison with the State Coordinators and plan the needed nets. Announcements and solicitations will follow. Since this is work on our usual frequencies, there will be plenty of candidates. Some of our state nets are readily convertible to this purpose, may indeed

(Continued on page 62)

Two U.H.F. Receivers Using the 9000 Series Tubes

A 112-224-Mc. Superregenerative and a 112-Mc. T.R.F. Receiver

BY BYRON GOODMAN,* WIJPE

The two receivers described here show how the new miniature tubes can be used to get to 112 and 224 Mc. in conventional circuits, and it describes some experiences with various types of detector circuits. The mechanical arrangements bear studying by any u.h.f. enthusiast, and an honest-to-goodness u.h.f. plug-in system is shown that takes away nothing from circuit efficiency and convenience.

THE new 9000 series tubes open up a lot of possibilities for compact and convenient arrangements of u.h.f. receivers. The converter described recently¹ showed how these tubes can be used in the front end of an u.h.f. superheterodyne, and this article will describe two superregenerative receivers that use the tubes.

The tubes are similar in internal structure to the "acorns" but they have the leads all coming out at one end. This is quite an advantage in laying out a receiver because the acorn tube, by the time it is mounted in a socket, has its terminals spaced quite a bit and hence reduces the possibilities for using really short leads. Further, the 9000 series are much easier to get in and out of the socket and — of no small importance — they are less expensive than the acorns.

Both of the receivers to be described went through several stages of mechanical and circuit

development. The work done on the detector circuit proved to be the most interesting (and aggravating!) and it will be mentioned briefly. Both receivers were originally built with separate quench oscillators. They were found to work very smoothly but they just didn't have the sensitivity and silencing effect that the self-quenched jobs have. Just why this is so is one of the things we plan to find out later — we suspect that it has to do with the waveform of the quenching voltage, since the full range of quenching voltage and amplitude was run through. Although the self-quenched detector proved to be more sensitive and to have better silencing action, it has the disadvantage that the signal comes in at a number of spots when the regeneration control is advanced into the region where the receiver first starts to hiss. Advancing the regeneration control a bit further cleans up this condition, but the separately-quenched detector is free from this effect because the quench frequency is more independent of the detector

* Assistant Technical Editor, *QST*.

¹ Grammer, "The New Miniature U.H.F. Receiving Tubes in a 56- and 112-Mc. Converter," *QST*, Sept., 1941.

Left — A close-up view of the tuning assembly shows how the leads from tuning condenser to tube socket have been kept short and how the coil socket is mounted on the tuning condenser. Hidden by the grid condenser (the 50- μ fd. condenser so prominent in the picture), the plate terminal of the tube socket goes to a lug that has been added to the rotor of the tuning condenser. Right — The arrangement of parts under the chassis can be seen in this photograph. The 6J5 socket is on the left and the 6F6 socket is on the right, near the speaker terminals.

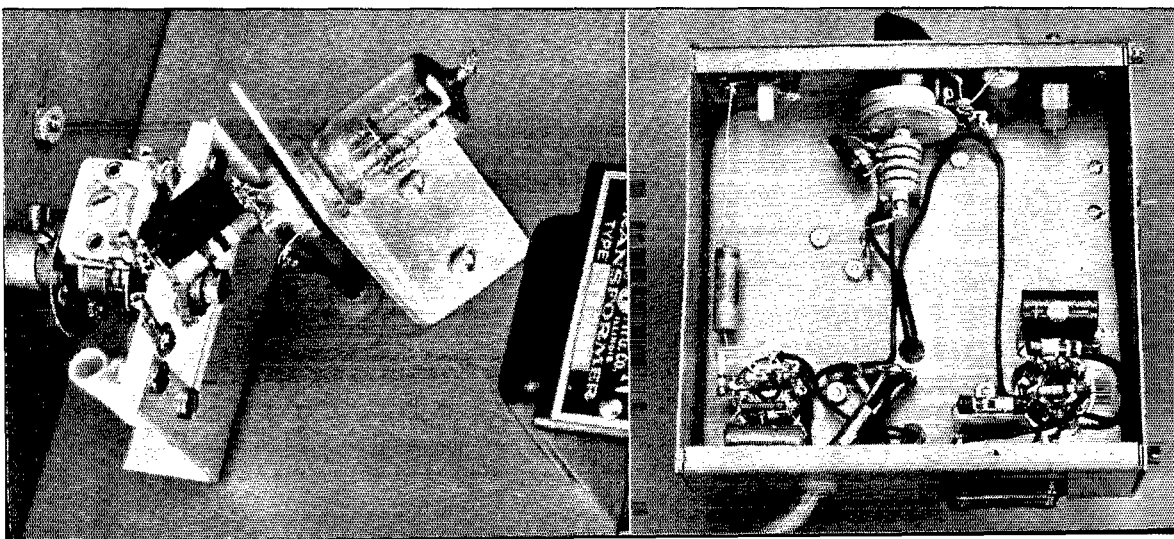

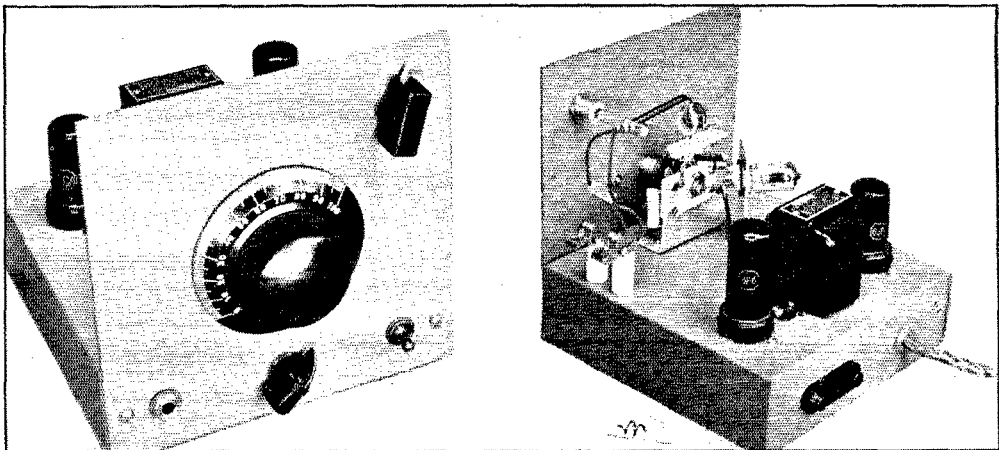

Left — The panel of the two-band superregenerative receiver measures 7 inches square. The knob in the upper right-hand control adjusts the antenna coupling and the knob below the tuning dial controls the regeneration. Right — A view of the back of the two-band superregenerative receiver shows the variable antenna coupling and the placement of parts. Note the 224-Mc. coil in the foreground — the 112-Mc. coil is in the coil socket.

action, and it is still an interesting problem to see if the separately-quenched detector can be made to give the same order of sensitivity. Further, it doesn't seem to pay to make the detector circuit too low- C — a low- C series-tuned circuit that was tried gave results not nearly as uniform as those obtained from the constants finally used. One reason for this, of course, is that the antenna coupling is not as uniform over the tuning range as with a tuned circuit having higher minimum capacity. Another advantage of

the higher C circuit is that bandsread is easier to obtain.

A Superregenerative Receiver for 112 and 224 Mc

The receiver shown in Fig. 1 has very good sensitivity on both 112 and 224 Mc., although it is not free from radiation as is a receiver with an r.f. stage. However, for the amateur who wishes to experiment on these two u.h.f. bands, this receiver will permit good reception at a minimum

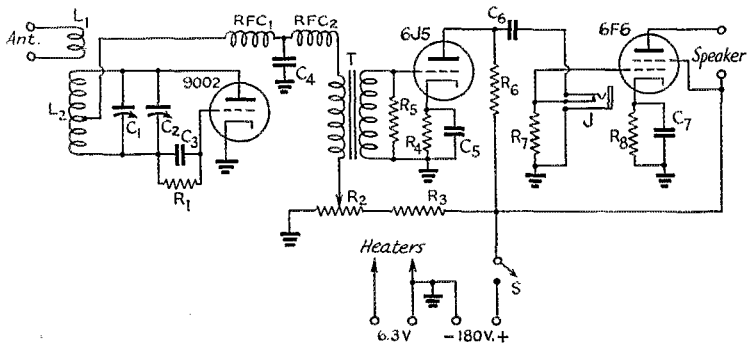
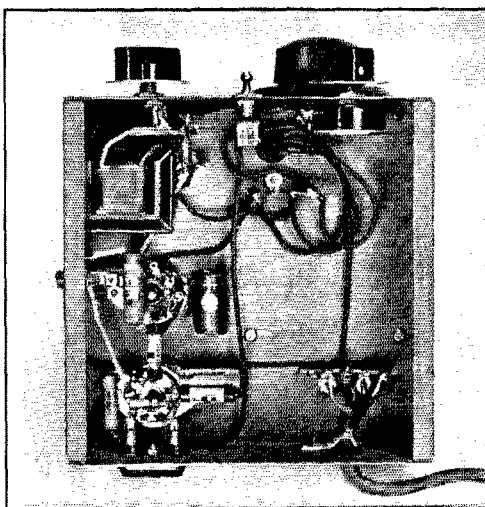
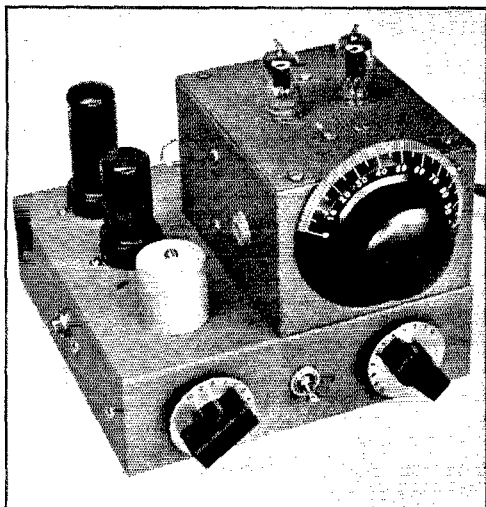

Fig. 1 — Wiring diagram of the two-band superregenerative receiver.

- | | | |
|--|---|--|
| C_1 — Two-plate variable (National UM-15 with 4 plates removed) | C_6 — 0.01- μ fd. paper, 400 volts | All resistors $\frac{1}{2}$ -watt carbon unless otherwise mentioned |
| C_2 — 3 — 30- μ fd. mica trimmer | R_1 — 10 megohms | J — Closed circuit jack |
| C_3 — 50- μ fd. mica | R_2 — 50,000-ohm potentiometer, wire-wound | S — S.p.s.t. toggle switch |
| C_4 — 0.003- μ fd. mica | R_3 — 0.1 megohms, 1 watt | T_1 — Single plate to single grid audio transformer (Thor-darson T57A36) |
| C_5, C_7 — 10- μ fd. electrolytic, 25 volts | R_4 — 2500 ohms | |
| L_1 — 1 turn No. 14 enam. wire, $\frac{3}{8}$ -inch inside diam. | R_5, R_6, R_7 — 0.1 megohms | |
| L_2 — 112 Mc.: 3 turns No. 18 enam., $\frac{1}{2}$ -inch diam., spaced to $\frac{1}{4}$ -inch winding length. Tap $1\frac{1}{4}$ turns from plate end. | R_8 — 500 ohms, 1 watt | |
| 224 Mc.: 2 turns No. 18 enam., $\frac{1}{4}$ -inch diam., spaced to $\frac{1}{2}$ -inch winding length. Tapped at center. | | |
| | RFC $_1$ — 25 turns No. 24 d.c.c. close-wound self-supporting. $\frac{1}{4}$ -inch inside diam. | |
| | RFC $_2$ — 8 mh. r.f. choke | |



Left — The 112-Mc. r.f. superregenerative receiver uses a 9001 r.f. stage, a 9002 detector, a 6J5 first audio and a 6F6 output stage. The knobs along the front are audio volume control (left) and regeneration control. The rubber grommet on the side of the 3- by 4- by 5-inch box centers the screwdriver used for setting the detector band-set condenser — a similar one is provided on the other side for the r.f. band-set adjustment. Note the 'phone jack on the side — the speaker terminals are located at the rear. Right — A view under the chassis of the r.f. receiver shows the audio transformer and some of the other components. Note the three wires coming through the chassis to the right of the B+ switch — they are the leads from the r.f. section of the receiver.

of expense. There is nothing unusual about the circuit — it is the self-quenched detector familiar to all u.h.f. men followed by two stages of audio amplification — but the arrangement of parts and the construction of the plug-in coils should prove interesting.

The receiver is built on a 7- by 7- by 2-inch chassis. The dial is mounted in the center of the panel and is connected to the tuning condenser by a bakelite flexible coupling. The condenser is mounted on a metal bracket cut out in the shape

of a "U" to clear the stator connections of the condenser.

The socket for the plug-in coils is made from the contacts taken from an Amphenol 78-7P miniature tube socket. They are obtained by squeezing the socket in a vise until the bakelite cracks, after which they can be easily removed. One of these contacts is soldered to each of the tuning condenser connections and a third is soldered to a lug supported by one of the extra holes of the Isolantite base of the tuning condenser. The only care necessary in mounting the contacts is to see that they are all the same height, so that the plug-in coil will seat well on them. The band-set condenser, C_2 , is mounted by soldering short strips of wire to the ends and then soldering these wires to the tuning condenser terminals.

The polystyrene tube socket for the 9002 is mounted on a metal bracket which is placed close enough to the tuning condenser to

The r.f. section of the receiver removed from the chassis. The detector tuning condenser is the one nearer the tuning dial and the detector socket is the one at the bottom of the picture. Note the interstage shield which is fastened to the side of the box. The trimming loop of the r.f. coil can be seen in the coil near the antenna posts.

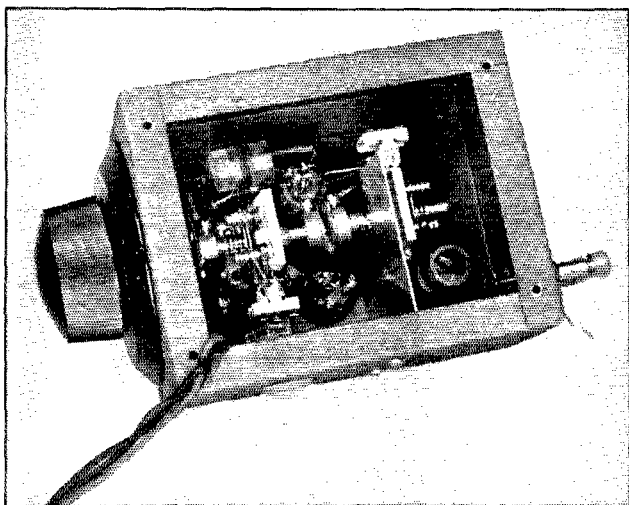

This close-up of the r.f. assembly shows the arrangement of parts and how the band-set condensers are mounted on the tuning condensers. Note the loose coil (upper left) which are soldered to the antenna posts after the assembly is returned to the box.

allow a very short lead from the tuning condenser to the plate connection and just enough room between the rotor of the condenser and the grid connection of the tube for the grid condenser to fit. The heater and cathode leads are brought down to the underside of the chassis through a rubber grommet.

The variable antenna coupling coil is mounted on a polystyrene rod supported by a shaft bearing. The rod is prevented from moving axially in the bearing by cementing a fiber washer to the shaft and tightening the knob on the other side so that the shaft does not move too freely. The antenna coupling loop should be adjusted so that it will just clear the coils when they are plugged in the socket.

None of the other components need special mention because their location can be determined from the photographs.

The coils are mounted on small strips of $\frac{1}{8}$ -inch polystyrene (Millen Quartz-Q) which have three small holes drilled in them corresponding exactly to the tops of the coil sockets. The No. 18 wire used for the coils will fit snugly in the sockets if the sockets are pinched slightly. A coil socket of this type allows very short leads to be used and is about the only thing practical until some manufacturer brings out a commercial product along these lines. The coils are trimmed to the bands by spreading the turns slightly, a procedure familiar to any u.h.f. man. However, in this case the band-set condenser gives some further range of adjustment and, in the receiver as described, it is screwed down fairly tightly for the 112-Mc. band and loosened about four revolutions for 224 Mc. If there are no good marker stations among the local amateurs, the Lecher wires described last month² are excellent for spotting the bands.

Two things will be found to influence the sensitivity of the receiver, the value of C_4 and the degree of antenna coupling. It is recommended that values of C_4 from 0.001 to 0.005 μ fd. be tried. The antenna coupling will, of course, vary greatly with the setting of the coil and with the type of antenna that is used, and it is well worth while to tune the antenna circuit and then vary the coupling with the panel control. Tight

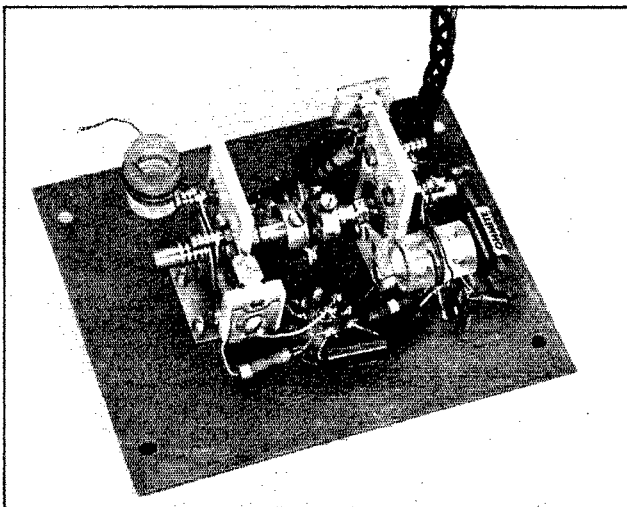

coupling will usually give better results than loose coupling, and the coupling can be increased almost up to the point where it is impossible to make the detector oscillate with no ill effects except increased radiation and QRM for other receivers in the vicinity.

No audio volume control was included in this receiver because the parts were held down to a minimum, but one could easily be added. In this receiver, the value of R_7 was adjusted until normal loud speaker output was obtained, and it can be varied to meet anyone's particular requirements.

A T. R. F. Superregenerative Receiver

A big problem in 112-Mc. work these days is the QRM caused by the radiation from superregenerative receivers. As far as is known, there are only two ways to lick this if superregenerative receivers are to be used: operate the detector at as low an input as possible by cutting down the plate voltage, or by adding an r.f. stage ahead of the detector to prevent the energy from reaching the antenna. The first is not a very satisfactory solution, but the second will do the trick in every case. Many a weak-signal contact has been broken up by two or three radiating receivers listening to the same signal or to one nearby in frequency — the receivers interfere over a wider frequency range than a good modulated-oscillator transmitter — and something will have to be done about it soon in the more congested areas if communication is to remain satisfactory. In time of emergency, a net-work operating on a spot frequency can run into trouble if the several receivers that must remain tuned to the frequency jam each other to any extent. A stage of r.f. ahead of the detector is the answer if one isn't interested in going to a converter and f.m.-i.f. amplifier (the ideal solution).

² "A Lecher Wire System for U.H. Frequency Measurement," *QST*, Oct., 1941.

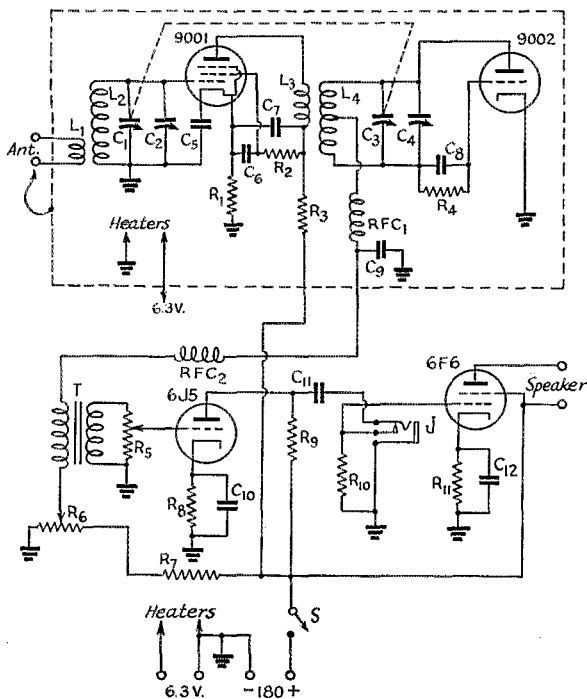

Fig. 2 — Wiring diagram of the 112-Mc. t.r.f. superregenerative receiver.

C₁, C₃ — 2-plate midget variable (National UM-15 with 4 plates removed) ganged

C₂, C₄ — 3 — 30- μ fd. mica trimmer (National M-30 or Millen 28030)

C₅, C₆, C₇ — 500- μ fd. mica

C₈ — 50- μ fd. mica

C₉ — 0.003- μ fd. mica

C₁₀, C₁₂ — 10- μ fd. electrolytic, 25 volts

C₁₁ — 0.01- μ fd. paper, 400 volts

R₁ — 200 ohms

R₂ — 0.25 megohms

R₃ — 10,000 ohms

R₄ — 10 megohms

R₅ — 0.5-megohm volume control

R₆ — 50,000-ohm regeneration control, wire-wound

R₇, R₉ — 0.1 megohm, 1 watt

R₈ — 2500 ohms

R₁₀ — 0.5 megohm

R₁₁ — 500 ohms, 1 watt

All resistors $\frac{1}{2}$ -watt carbon unless otherwise mentioned

L₁ — 1 $\frac{3}{4}$ turns No. 28 d.s.c. interwound between L₂

L₂ — 2 turns No. 20 enam., $\frac{1}{4}$ -inch winding length. See text for trimming method.

L₃ — 1 $\frac{1}{2}$ turns No. 28 d.s.c. interwound between L₄.

L₄ — 2 $\frac{1}{4}$ turns No. 20 enam., $\frac{1}{4}$ -inch winding length. Tapped $\frac{1}{2}$ turn from plate end. See text for trimming method.

L₁-L₂ and L₃-L₄ wound on National PRE-1 forms.

RFC₁ — U.h.f. r.f. choke (Ohmite Z-1)

RFC₂ — Low-frequency choke (National OSR with windings in series. Connect B+ and Gnd together.)

J — Closed circuit jack

S — S.p.s.t. toggle switch.

T₁ — Single plate to single grid audio transformer (Thordarson T-13A34).

The circuit shown in Fig. 2 is practically identical to that of Fig. 1 with the exception that a stage of tuned r.f. amplification and an audio gain control have been added. The 9001 used for the r.f. amplifier gives some slight gain, good freedom from antenna effects and — most important of all — it prevents any radiation from the receiver.

The arrangement of parts, as shown in the photographs, is convenient in that it gives a fully-shielded receiver (except for the r.f. tubes) that is easy to work on. The r.f. unit can be demounted from the chassis and worked with separately and, once adjusted, it can be replaced and left alone. The receiver is a one-band affair, but the only disadvantage there is lack of economy. The main chassis is 7- by 7- by 2 inches and contains the audio end of things and the volume and regeneration controls. The r.f. portion is housed in a 3- by 4- by 5-inch box and everything but the dial and antenna terminals are mounted on a removable cover, enabling the builder to get at the parts easily. Only three leads are brought down from this box to the main chassis, and they are left long enough so that they do not need to be unsoldered every time the box is removed from the chassis. A shield mounted on the side of the box helps to prevent

coupling between the r.f. and detector coils. Holes on either side of the box allow the trimmer condensers to be adjusted when the receiver has been finally assembled.

As can be seen from the close-up view of the r.f. portion, the two tuning condensers and the two sockets are mounted on the removable top of the box and they support all of the components. The trimmer condensers are soldered directly to the tuning condenser terminals and the coils are self-supported by their leads. A tie strip takes the leads that run out of the box and also serves as a convenient point to fasten RFC₁, C₉ and some of the other resistors and condensers. The leads are not quite as short in this arrangement as they are in the other receiver, but it makes no difference because the receiver is built only for 112 Mc. and does not have to get down to 230 Mc.

The coils are wound on small polystyrene forms. It is suggested that the No. 20 wire coils be wound first and the plate tap for L₄ soldered. The coils can then be doped and, when the dope has dried, the fine wire coils can then be more easily wound in between the turns and fastened with dope. The No. 20 wire coils run through holes in the forms, while dope only is used to keep

(Continued on page 62)

A Coupling Unit for Continuous Antenna Rotation

Simple and Effective System for Rotary Beams

BY ELLERY L. PLOTTS,* W9WJP

A novel and thoroughly-tested method of making good contact to feeder wires in continuously-rotatable beam construction. Dope on the electrical details of matching the line to the antenna is included.

THE coupling system to be described represents the accumulation of several years' experience and ideas, both my own and others'. Up to the present time I have seen but one other simple, positive, continuously-rotatable, trouble-proof system of coupling the transmission line to the rotary array.

Several years ago, in the course of the writer's regular work, almost continuous trouble was experienced with the contacts on the loop of a field set. A contact system was designed which proved its value, for in all the following years of its use we never experienced any noise or had any trouble with poor contact. The constructional idea, which is really very simple, has been applied to a rotary array and is shown in Fig. 1. Two brass discs $\frac{1}{4}$ inch thick were turned out on a lathe from a piece of 3-inch brass stock, then grooved to form a shallow pulley. Three holes are drilled in the discs, 120° apart on a circle whose diameter is two inches; these are used for mounting the isolantite spacing insulators. The lower ring has a clearance hole drilled in its center for the inner conductor of a concentric line, while the upper one is drilled for clearance of the outer conductor. A press fit is to be desired. After being sure that the assembly will turn true, the rings may be soldered in place.

Next we were interested in getting a noise-free, low-resistance contact to the rings. This was accomplished by covering a flexible wire with several layers of tinned copper braid. The outside diameter of the built-up braid should be such that it will fit snugly into the grooves in the rings. The braided wire is looped around the ring and both ends soldered into heavy-duty lug, which may be used for the connection and also as a point to attach a medium-stiff spring which will assure a positive wiping contact at all times. A little vaseline or other petroleum lubricant on this

unit is of considerable help. If the antenna is to be fed with an open-wire line, as mine is, it is convenient to have the springs 180° apart, thus neutralizing the pull that would occur were they on the same side.

What mechanical and electrical methods are suitable for connecting the slip rings to the array? Most rotating heads have a hollow shaft through the driving unit — mine has a 2-inch shaft about 18 inches long. If a short piece of $\frac{3}{8}$ - or $\frac{1}{2}$ -inch concentric line is used as a means of coupling the slip rings to the array, the mechanical support and the electrical feed problems would be solved at the same time. From transmission line theory and experience we know that when a short line is terminated by a low impedance, then the input impedance is approximately equal to the terminal impedance. (This is true only within certain limits and over a narrow frequency band.)

The center impedance of the driven element of a close-spaced array is in the vicinity of 8 ohms. This is one reason why it is necessary to have a low-resistance, positive contact at the slip rings. The contact must be nearly perfect, since with anything more than flea-power the high currents will result in prohibitive losses.

Making use of a piece of $\frac{1}{4}$ -inch concentric

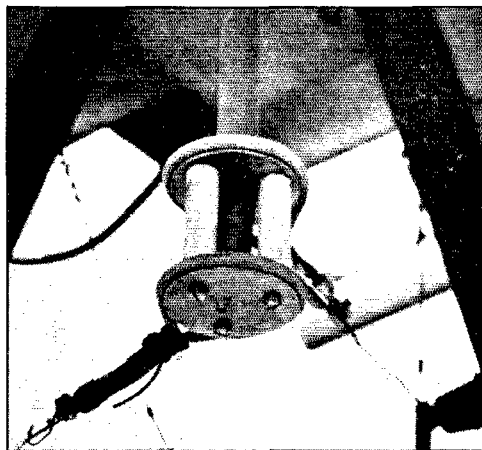

A close-up of the slip-ring assembly, showing the built-up braid rope sliding contact.

* 2509 East 76 St., Chicago, Ill.

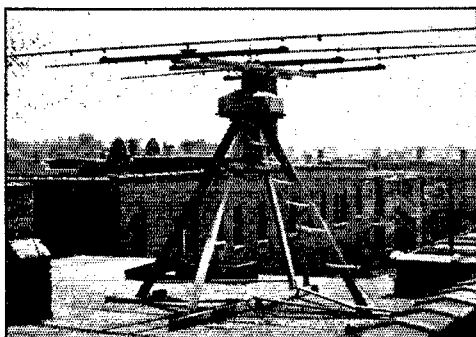

The rotary beam antenna at W9WJP, using the contact system and matching section described in the article.

line I had available, a test was made to prove the feasibility of the coupling. An 8-ohm piece of nichrome from a flat iron element was connected in series with an ammeter and this combination terminated one end of the concentric line, which was 34 inches long. On the assumption that the input impedance was 8 ohms, a matching unit of type shown in Fig. 2 was calculated and constructed to match the input impedance to the line impedance, which was 500 ohms. The method

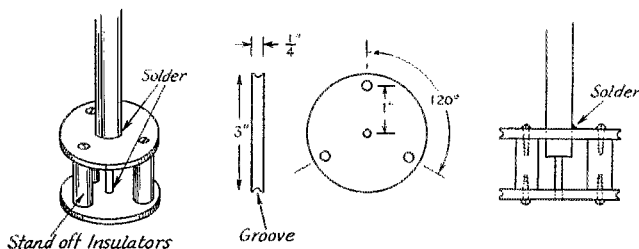

Fig. 1 — Details of the slip-ring assembly.

of calculating these matching units has been given in several articles; one appears in the October, 1939, issue of *QST*.¹ The network and design constants are given in Fig. 2.

The test unit was then coupled to the transmitter. The input to the final stage remained the same regardless of whether a 500-ohm dummy antenna or the test unit was coupled to it. It was not necessary to retune during any of these tests, indicating that the matching unit was performing in excellent fashion. The power (I^2R) into the 8-ohm load was calculated and it was gratifying to find that the power loss was only a few per cent; in fact, it was well within the accuracy of measurement.

Although the test made in the transmitter room gave excellent results, the real test came when the unit was coupled to the antenna and

transmission line. It justified all expectations. The transmitter loading was approximately the same, and there were no standing waves on the transmission line, indicating nearly a perfect match. Had standing waves appeared on the line it would have meant that the center impedance of the array was not 8 ohms. Then the matching network would have had to be redesigned for other impedances and various tests made to determine the right value. One could determine the antenna resistance by substituting a resistor and obtaining the same standing-wave ratio, then measuring the value of the resistor. This would only be approximate, but might save a little time. It wasn't necessary in my case.

One further question: How far off frequency can the system be operated without seriously affecting the power input? This can be answered by saying that with my antenna, which is tuned to 29.1 Mc., the change in plate input is only 10% for a 600-kc. change in frequency. It is assumed that this is entirely the result of the change in antenna impedance, but no measurements have been made to justify this assumption; perhaps someone will care to investigate the point.

For those who want additional information: At present I am using a $\frac{5}{8}$ -inch hard-drawn copper concentric line which is insulated from the walls of the driving unit by bakelite rings $\frac{1}{2}$ inch thick. A larger bakelite washer and a small collar attached to the concentric line keep the line from falling through the shaft. I am using a standard end-seal for the top of the concentric to keep out water. This is rigidly coupled to one element of the array, and thus the line cannot turn except

when the array is rotated. Warning: Don't use aluminum condensers in the matching unit unless it is protected from the weather and smoke. Two of mine have disintegrated. We know that a short piece of open-ended concentric line acts as a capacity and can be used for this purpose; with its use your troubles should be over. The length will depend upon the size and type and the frequency, but in the 10-meter band it should be somewhere between 6 inches and a foot, as a guess, but the capacity per unit length had best be secured from the manufacturer.

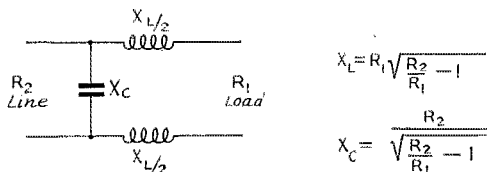
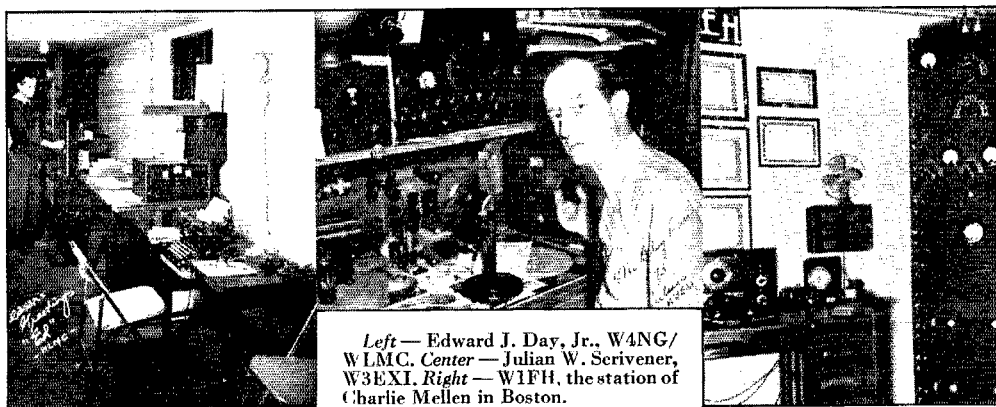

Fig. 2 — Matching section and design formulas. The "load" is the concentric line connecting to the antenna.

¹ W. M. Andrew, "An R.F. Matching Network for General Use," *QST*, October, 1939.



Left — Edward J. Day, Jr., W4NG/WLMC. Center — Julian W. Scrivener, W3EXI. Right — W1FH, the station of Charlie Mellen in Boston.

U. S. ANTARCTIC SERVICE EXPRESSES APPRECIATION

UNITED STATES

DEPARTMENT OF THE INTERIOR

OFFICE OF THE SECRETARY

DIVISION OF TERRITORIES AND ISLAND POSSESSIONS

WASHINGTON

September 4, 1941

Dear Sir:

I wish to express my appreciation and sincere thanks to all of the U. S. amateurs for their splendid cooperation and courteous services to the KC4 stations of the U. S. Antarctic Service during our recent sojourn in Antarctica. Their many courtesies and their efforts in keeping our channels clear, permitting us to come through with as little QRM as possible, are gratifying, and without them we could never have enjoyed the many pleasant hours spent on the amateur bands.

In order that all members of our party could enjoy this privilege as much as possible, our operations in the c.w. bands were curtailed, as few of us worked c.w., whereas everyone worked 'phone. I regret that more c.w. QSO's were not possible.

Although we contacted approximately 1200 stations during our stay on the ice, we know that many more were calling that "just couldn't make it." Conditions throughout were generally poor. The most consistent and reliable year-around contacts for KC4USA were on the East Coast.

A few years ago, at a different point in the solar cycle, the West Coast stood out and the East Coast boys were in the mud. Which coast will present the better year-around contacts when again another expedition goes into the Antarctic depends upon many factors, such as the sun-spot cycle, etc.

Amateur communication has been of inestimable value to the members of this expedition in permitting most of the men on the ice to have periodic direct 'phone contacts with their fami-

lies and friends, and in providing a channel for unlimited personal messages. For the latter, the expedition owes a great debt of gratitude to Edward J. Day, Jr., W4NG/WLMC, and B. Aldwell, W6LMB/WLMM, of the AARS for their undivided attention in handling our personal traffic. Mr. Day at WLMC guarded us nightly from 25 November 1939 until 4 May 1941 (that's right — down, there, and back), and something like 15,000 messages passed over this circuit. WLMM handled a great portion of the East Base personal traffic during periods when that station couldn't work the East Coast.

Being centrally located in the nation's capital, Julian W. ("Skunk") Scrivener, W3EXI, was in a position to render the expedition a great service, not only by permitting personal 'phone contacts between the men at the bases and their families and friends at home, but also enabling the expedition officials in Washington to have a more personal contact with the men in the field and maintaining regular check-in observation schedules on 20 meters.

When KC4USA secured on 12 January 1941, W3EXI had established 187 good or perfect QSO's and had spent a total of 86 hours and 45 minutes on the air in contact with KC4USA. Last, but by no means least, Charlie Mellen, W1FH, in Boston, by prearrangement maintained regular check-in and observation schedules. When the station secured on 12 January 1941, W1FH had established 236 good to perfect contacts with a total of 100 hours and 45 minutes

(Continued on page 68)

● For the Junior Constructor —

An Antenna Tuner for the Beginner

A Low-Power Coupler and How to Use It

ANTENNAS fed by tuned lines have long been popular with old hands at the game as well as beginners. The use of transmission lines permits the antenna to be placed in the most favorable position available without regard to the location of the transmitter. While the line may be either tuned or untuned, the tuned line is more tolerant in adjustment and is, therefore, more easily handled by the beginner.

While it is possible to connect a tuned line directly to the tank coil, this practice is not recommended, because not only is it impossible to segregate the tuning of the transmitter output tank and that of the antenna system, but also direct coupling provides an excellent means of introducing undesired harmonic frequencies in the antenna system. For these reasons, it is advisable to provide a separate circuit for tuning the antenna system.

This tank circuit may be coupled to the transmitter output tank circuit by placing the two coils in inductive relation to each other. Coupling may be adjusted by changing the distance between the two coils. Another method of coupling the two circuits, more popular in recent years, is one in which the two circuits are coupled with a low-impedance line or "link" between the two. This permits mounting the antenna tuner at a

distance from the transmitter, if desirable, and allows the antenna coil to be fixed in position, the coupling being adjusted by altering the number

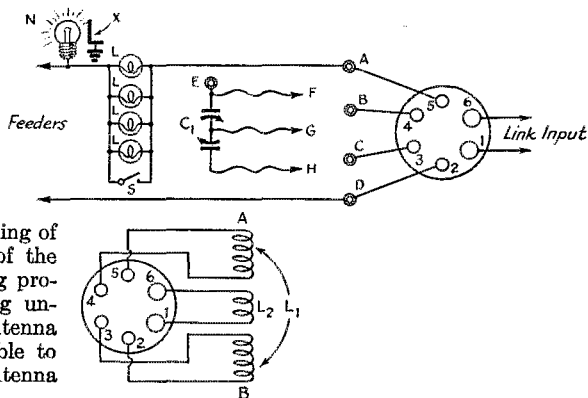

Fig. 1—Circuit diagram of the low-power antenna tuner.

Section A shows the connections to the coil socket. C_1 has a capacity of 140 μfd . per section (Hammarlund MCD-140). L is a 250-ma. dial light, No. 46. N is a $\frac{1}{4}$ -watt neon bulb. X is a grounded piece of metal to form a capacity for igniting the neon bulb. S is a switch or clip for short-circuiting the lamps after tuning.

B shows the connections to the 6 pins of the coil form. L_1 , whose approximate dimensions are given below, is wound in two sections on the form, with the link winding, L_2 , in between.

L_1 — 1.75 Mc. — 20 turns No. 22 enam., $\frac{3}{4}$ -in. long each section, $\frac{1}{2}$ -in. space between sections, 40 turns total.

3.5 Mc. — 11 turns No. 20 enam., $\frac{3}{4}$ -in. long each section, $\frac{1}{2}$ -in. between sections, 22 turns total.

7 Mc. — 6 turns No. 20 enam., $\frac{3}{4}$ -in. long each section, $\frac{1}{2}$ -in. space between sections, 12 turns total.

14 Mc. — 3 turns No. 20 enam., $\frac{1}{2}$ -in. long each section, $\frac{1}{4}$ -in. space between sections, 6 turns total.

Number of turns for the link winding, L_2 , will vary from 2 to 6 or 8 turns, depending upon coupling required for proper loading. Coils are wound on Hammarlund 6-prong, $1\frac{1}{2}$ -in. diameter forms.

of turns in the link coil at each end of the line. Providing the power-output level does not change greatly, the same antenna tuner may be used with several different transmitters without rebuilding it.

Such an antenna tuner is shown in the photographs and the circuit diagram is shown in Fig. 1. In the form shown, it may be mounted on the operating table within easy reach and view of the operator. It consists essentially of a plug-in coil and tuning condenser with a system of clips by

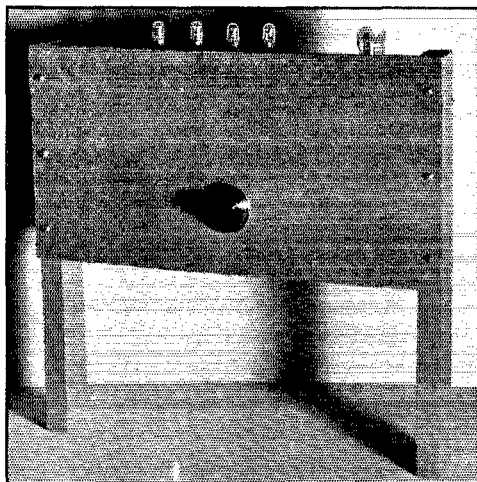

The low-power antenna tuner is built up in panel form to mount on the operating table within reach of the operator. The indicator lamps are visible from the front.

which several different combinations of inductance and capacity may be selected to suit requirements. Since meters to indicate r.f. current in the feeders are expensive, cheap dial lamps and a neon bulb serve as indicators of optimum antenna-circuit adjustment.

Construction

The two uprights and the strip supporting the indicating lamps are pieces of "one-by-two" stock. The uprights are each 13 inches long, while the cross-strip is 12 inches long, although these dimensions may be changed to suit the constructor. The shelf for the condenser and coil is made of a piece of crate wood $4\frac{1}{2}$ inches wide. The panel may be made from a scrap of plywood 7 inches high and the whole thing may be given a couple coats of shellac or paint to suit the taste.

The dial lamps are soldered to a pair of parallel wires supported at each end on small stand-off insulators. The bottom of the neon bulb is soldered to a short piece of wire between a third pair of standoffs. The piece of grounded metal next to the neon bulb is about $1\frac{3}{4}$ inches square. This provides a capacity to ground to enable the neon bulb to operate without touching the hand to it.

The socket for the plug-in coil is mounted on the shelf with spacers and wood screws. The shield between the two sections of the variable condenser is removed to allow mounting with a screw through the hole to the shelf. The shaft of the condenser is cut off and an insulating coupling inserted between the shaft and the control knob. The contacts for shifting connections consist of machine screws set in a small strip of bakelite.

Antenna and Feeder Dimensions

In order to avoid possible difficulties in tuning and coupling, both antenna and feeders should be cut within reasonably-close limits dependent upon the frequency at which the transmitter is operating. Charts are shown from which both proper antenna length and feeder length may be determined for any frequency. To determine the length of the antenna, place a point on the horizontal scale at the desired frequency. Now

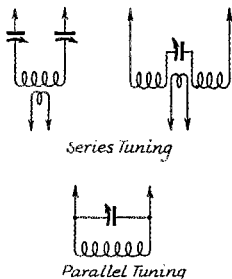
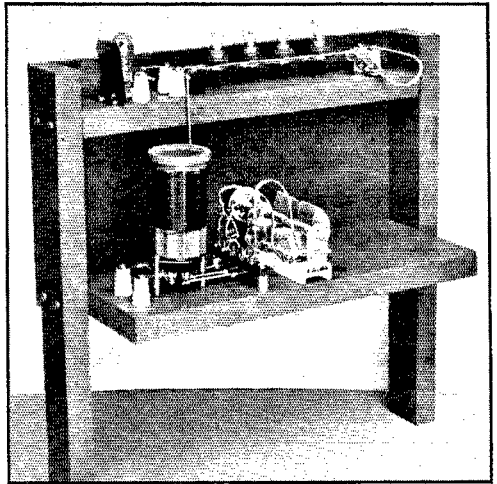

Fig. 2 — Circuits for series and parallel tuning. Separate series condensers may be used in the feeders or a single condenser may be used at the center of the coil to maintain balance.



Rear view of the low-power antenna tuner.

run the point vertically until it hits the solid diagonal line. Then run the point horizontally to the left to the vertical scale which will show the proper length of antenna. With a center-fed antenna, the length given is the sum of the lengths of the two halves of the antenna.

To determine the length of feeders to use with this antenna, start out as before, but run vertically to the dotted diagonal line and, thence horizontally, to the right to the vertical scale indicating feeder lengths. Choice of feeder lengths for the same frequency is given so that some selection is possible in choosing a length which will cover the distance between antenna and transmitter. The lengths used should not vary more than 25 per cent of the length given in the *first* feeder-length column of each chart. If a 125-foot antenna with 187.5-foot feeders are chosen, both should be within 25 per cent of 62.5 feet (3.5-Mc. Chart), the length given in the first column. Be sure to include any length of feeder which must be run inside the station to reach the coupler terminals.

End Feed or Center Feed

Tuned feeders are normally used either at the center of the antenna or at one end. Center feed is preferable whenever possible, since a balanced line is automatically maintained, regardless of antenna length. With the end-fed or Zepp system, a complete balance is never possible and the situation becomes worse as the length of the antenna varies from the exact proper length for the frequency in use. If the antenna is operated at a harmonic, different patterns of directivity will be obtained with end feed and center feed.¹

¹ Don Mix, "Antennas for Domestic Work," *QST*, Sept., 1941.

Charts showing correct antenna and feeder lengths for antennas fed by tuned lines for frequencies in the 1.75-, 3.5-, 7- and 14-Mc. bands.

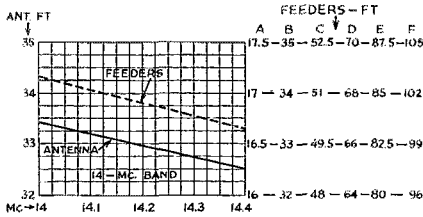

Chart for 14-Mc. band. With end feed, use series tuning for A, C and E; parallel for B, D and F. With center feed, use series tuning for B, D and F; parallel for A, C and E.

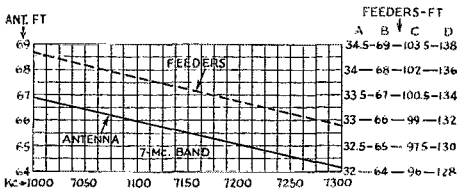

Chart for 7-Mc. band. With end feed, use series tuning for A and C; parallel for B and D. With center feed, use series tuning for B and D; parallel for A and B.

Series and Parallel Tuning

With feeders of certain lengths the antenna-tuner tank circuit must be connected in series with the feeders, while for other lengths it must be connected in parallel, as shown in Fig. 2, to resonate. Feeder balance will be maintained with series tuning by the use of separate condensers, one in each feeder, set to equal capacities or by a single condenser at the center of the coil. For any given length of feeder, the proper use of series or parallel tuning will depend upon whether the antenna is end fed or center fed. The correct sys-

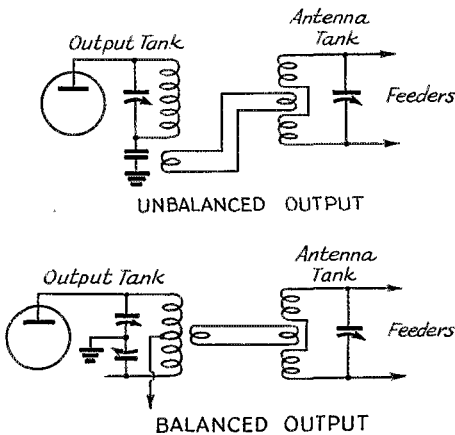

Fig. 3 — The antenna tuner is coupled to the output stage with a link line. The link at the transmitter end is coupled to one end of the coil if the output circuit is unbalanced or to the center if a balanced circuit is used.

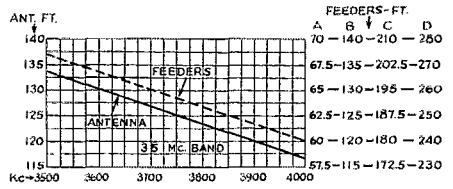

Chart for 3.5-Mc. band. With end feed, use series tuning for A and C; parallel for B and D. With center feed, use series tuning for B and D; parallel for A and C.

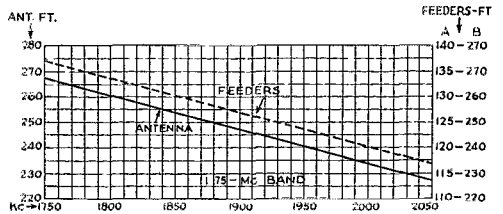

Chart for 1.75-Mc. band. With end feed, use series tuning for A; parallel for B. With center feed, use parallel tuning for A; series for B.

tem to use with feeders of any chosen length is indicated above the feeder-length columns to the right of each chart.

The antenna tuner shown in the pictures is arranged so that either series or parallel tuning may be used at will by shifting the position of the clips marked *F*, *G* and *H* in the diagram. *A*, *B*, *C* and *D* represent the four machine-screw contacts in the strip near the coil, while *E* represents a contact on the rear stator of the condenser. When *F* is connected to *A*, *H* to *D* and *B* to *C*, the two sections of *C*₁ in series are connected across *L*₁, forming a low-capacity parallel-tuned circuit. When *H* is connected to *E* and *G* to *D*, other connections remaining the same, a high-capacity parallel circuit is formed. For series tuning, *H* is connected to *E*, *F* to *B* and *G* to *C*. A low-capacity series-tuned circuit is formed by connecting *F* to *B* and *H* to *C*. The high-capacity circuits will be used at the lower frequencies, while the low-capacity connections will be found useful at the higher frequencies. Approximate coil dimensions for parallel tuning for each band are given under the diagram. Slight alterations in specific instances may be required. Where series tuning is required, the coil for the next-higher frequency band will usually be satisfactory.

Tuning

The antenna tuner and the output tank circuit should be coupled by a link line as illustrated in Fig. 3. This line may consist of a pair of closely-spaced parallel wires. When the tank circuit of the output stage is unbalanced, the link at that end

(Continued on page 68)

★ WHAT THE LEAGUE IS DOING ★

EXTENSION FOR RENEWAL-APS

FCC on September 25th amended its Order No. 76-A to change the specified date therein, in three places, to read December 31, 1941. (Text on page 22, April *QST*.) Net effect:

Amateurs whose station or operator licenses expire before the end of the year (and who haven't been granted or denied renewal and who haven't got into trouble with FCC) are given automatic extensions of license through Dec. 31st (if it takes that long to receive renewal), provided proper application for renewal and a showing of citizenship have been filed with FCC.

POLICING OUR BANDS

THE recent trial of foreign spies in Brooklyn has revealed that for over a year the FBI operated a counter-espionage station in our 14-Mc. band, posing as a station illegally operated by foreign agents. The station was in communication with Europe several times a week, handled nearly 500 messages in five-letter code, employed amateur procedure but signed phony three-letter calls. We understand that only one amateur reported it, and he late in the station's life. A New York paper criticizes us for failure in the trust the public reposed in us to spot misuses of our frequencies.

They forget, or do not know, that the government has anything but encouraged us in intercept work, having an adequate monitoring service of its own and, in fact, in the early months of the developing emergency, warning us that the secrecy provisions protected authorized stations. Moreover, there is so much "authorized" non-amateur stuff in our bands nowadays that it is difficult for anyone but an expert to discern a phony — it may be Army stations making a temporary use of our frequencies during maneuvers, or something in the North Atlantic patrol, or some of the RAF's high-speed point-to-point service, and so on.

However, ARRL headquarters believes that it is now time for us to take a more realistic view of the subject. It is apparent that the government will now welcome our collaboration and that the public expects it of us. We do not need to organize ourselves into a large and formal listening corps, patrolling the whole ether, but we can make a contribution by assisting in watching our own busy bands, which are so active that a large number of observers is helpful. We therefore state that we consider the time has arrived for us to resume the active monitoring and reporting of activities on amateur frequencies that are perceived to be,

or are suspected of being, improper. Logs and reports are accordingly solicited, the data to be centralized by ARRL and passed on where they will do the most good. Most important, of course, will be frequency, calls, hours of operation and nature of correspondence. Supply as many particulars as you can. We'll do the rest.

"LET GEORGE DO IT"

GEORGE W. BAILEY, president of the League, must be a busy man in Washington these days. In addition to his work as chairman of the radio section of the Office of Scientific Personnel, National Research Council, he has become special assistant to the chairman of the National Defense Research Committee. In the work of DCB, in addition to being the chairman of the Amateur Radio Committee he has been named a member of a recently-appointed committee for liaison with OCD on civilian defense matters. Many of the DCB committees are appointing advisers to the newest DCB creation, a committee concerned with defense priorities, and George will be an adviser to this committee from both the Amateur and Liaison committees. In his representation of the amateur committee, he will have the assistance of F. Cheyney Beekley, *QST*'s advertising manager, who is well informed on conditions in the industry.

WORKING ARMY STATIONS

IN THIS department last month it was incorrectly implied that, under Section 2.91 of the FCC rules, amateurs might feel free to work during maneuvers with Army stations which solicit their cooperation. FCC has been surprised to discover that its rule indeed so reads, but it seems that it was intended only to permit commercial stations to get around their tariffs and grant free service during maneuvers. The language of the rule will probably be amended soon to clarify its meaning.

In the recent maneuvers in the Northwest, Army field commanders got the collaboration of

(Continued on page 70)

ARE YOU LICENSED?

When joining the League or renewing your membership, it is important that you show whether you have an amateur license, either station or operator. Please state your call and/or the class of operator license held, that we may verify your classification.

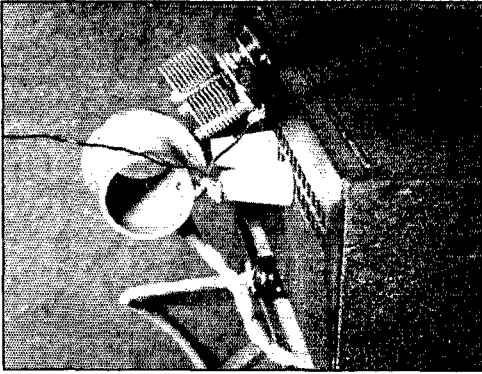

A Soldier's Portable

BY GLENN ROOF,* WBOPG

◆
 The antenna coupler mounts on the rear of the chassis, with the tuning condenser mounted on stiff wiring to the jack-top stand-offs. The knob is easily reached over the lid of the cabinet.
 ◆

Midget Station to Fit in an Army Foot Locker

I USED to take great care with my transmitters to see that they weren't bumped around or dropped on the floor. But now I'm hardened to watching my pride and joy get the works — and I mean the real knock-'em-down, push-'em-around stuff. I think I've stood on a dozen railroad platforms and watched the baggage smashers do their worst. The first time was a horrible affair that will stick with me for a long time. I was in the yard at Nashville, Tennessee, watching the unloading of one of the cars. One Army foot locker was taking a terrible beating. I was pretty sure they wouldn't do that to mine — didn't I have a "Fragile" sticker on it? — but imagine my horror when, on one of the slower revolutions, I read "Sgt. Glenn Roof" on the end. My transmitter and receiver were in that locker, and I wished they weren't. That is one of the most important things to consider in a portable job — durability.

When I set it up at Camp Forrest the final wouldn't pull any current. I knew immediately what and where the trouble was and fixed it in five or ten minutes. That's the second point — simplicity.

* Staff Sgt., 2nd Squadron Hq. Det., 107th Cavalry Rgt., Camp Forrest, Tenn.

When I started operating, the reports were extremely gratifying, which is the final point — it has to put out.

So we're looking for a rig that's simple and yet can take it and still put out. Just one more thing: A soldier hasn't a whole lot of room at any time so space is at a premium. It was with these qualities in mind that I built the station described here. So far the results have been well worth the time and trouble.

The transmitter is designed to take up half of a standard Army foot locker, which measures 26 × 12 × 15 inches. The transmitter and receiver are contained in two cabinets each 12 × 8 × 8 inches; the a.c. and 6-volt d.c. supplies are in one and the rest of the outfit in the other.

Power Supplies

The 6-volt pack is a Mallory VP552 with 8 feet of No. 12 rubber-covered cable. Since a.c. would not always be available I thought it best to include this Vibrapack. It is mounted in one end of the cabinet, bolted vertically to the front panel. Since the largest items were the a.c. power units, it took some juggling to fit them into the space. A 500-volt 150-ma. transformer is about

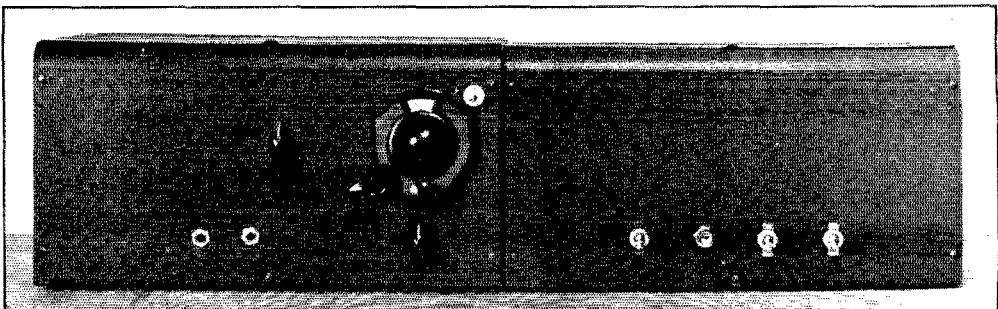

The complete station. Transmitter and receiver in the left-hand cabinet, a.c. and vibrator power-supplies in the right.

the best that can be done so far as output and space are concerned. The choke is a 100-ma. unit that heats up a little when the transmitter is used for long periods at a crack, but since there is no more room it has to do. There is no ripple on the note so it can't be overloaded too much. An 80 is used as the rectifier even though the rating isn't up to the work it does; however, none has blown yet. Two were smashed in transit, but that doesn't count. The receiver supply is conventional, with a 230-volt transformer and 16 $\mu\text{f.}$ in the filter. The 110-volt input cord is soldered in permanently, with a knot on the inside to prevent its being pulled out accidentally.

From left to right on the front panel the switches are: d.c. plate switch; a.c. filament and

main plate switch, receiver plate, and transmitter plate. All are toggle switches except the filament switch, which is of the key locking type. This was done to comply with the rule that the equipment would be available only to the operator and also to prevent its being turned on accidentally. These are the only switches in the unit and, outside of the original process of turning on the voltages, they are not touched while operating. Changing from a.c. to d.c. is a simple operation and it can be done in 18 seconds flat. At the back of the chassis are two 6-prong sockets, one alongside the a.c. and one by the d.c. supply; these are the power outlets. When changing from a.c. to d.c. you simply pull the plug out, plug it into the other socket, and turn on the switch. All in all, the

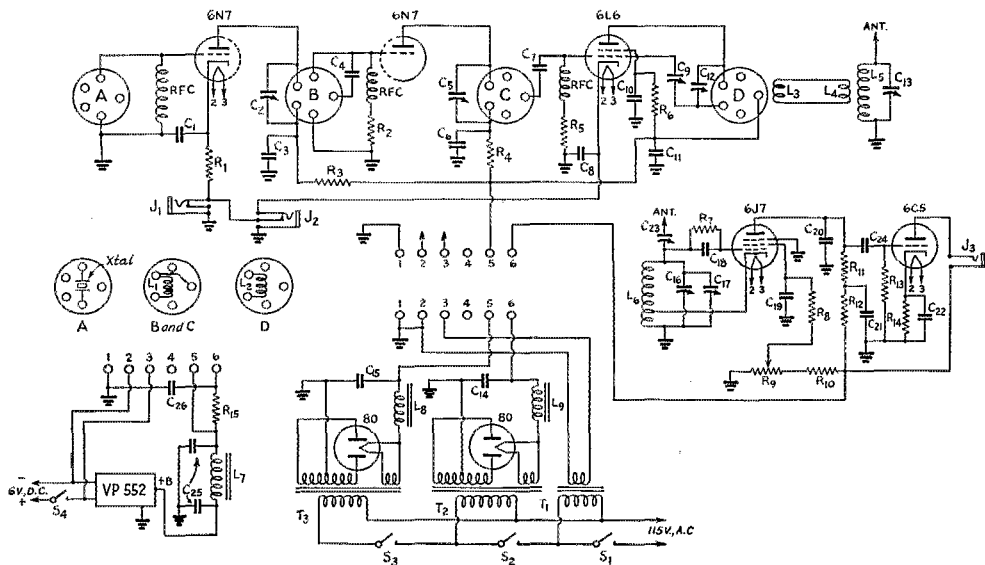
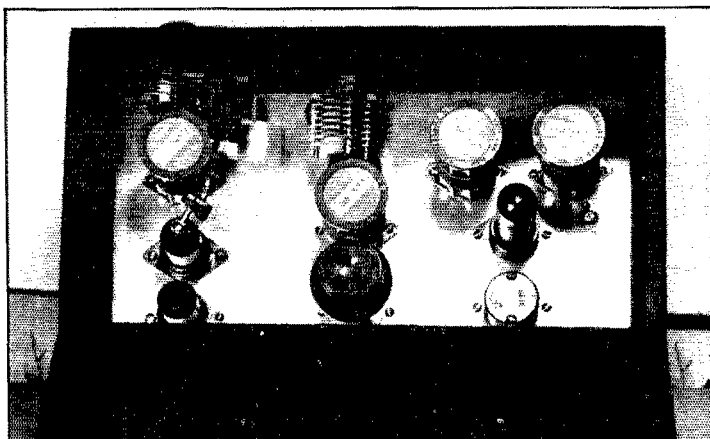

Fig. 1 — Circuit diagram of the portable station.

- C₁, C₈ — 0.006- $\mu\text{f.}$ paper, 600 volts.
- C₂, C₅ — 75- $\mu\text{f.}$ air trimmer.
- C₃ — 0.01- $\mu\text{f.}$ paper, 600 volts.
- C₄, C₇, C₁₈, C₂₀ — 100- $\mu\text{f.}$ mica.
- C₆ — 0.002- $\mu\text{f.}$ mica.
- C₉ — 61.6 neutralizing condenser.
- C₁₀ — 0.002- $\mu\text{f.}$ paper, 600 volts.
- C₁₁ — 0.003 $\mu\text{f.}$ (two 600-volt paper condensers in series).
- C₁₂ — 50- $\mu\text{f.}$ variable, double-spaced.
- C₁₃ — 140- $\mu\text{f.}$ variable.
- C₁₄ — 16- $\mu\text{f.}$ electrolytic, 350 volts (two 8- $\mu\text{f.}$ units in parallel).
- C₁₅ — 4- $\mu\text{f.}$ electrolytic, 900 volts (two 8- $\mu\text{f.}$ 450-volt units in series).
- C₁₆ — 100- $\mu\text{f.}$ variable.
- C₁₇ — 15- $\mu\text{f.}$ variable.
- C₁₉ — 1- $\mu\text{f.}$ paper.
- C₂₁, C₂₂ — 0.5- $\mu\text{f.}$ paper.
- C₂₃ — 3-30- $\mu\text{f.}$ mica trimmer.
- C₂₄ — 0.006- $\mu\text{f.}$ mica.
- C₂₅ — Dual 8- $\mu\text{f.}$ electrolytic, 450 volts.
- C₂₆ — 8- $\mu\text{f.}$ electrolytic, 350 volts.
- R₁ — 300 ohms, 10 watts.
- R₂ — 75,000 ohms, 1 watt.

- R₃, R₄, R₆ — 15,000 ohms, 10 watts.
- R₅ — 50,000 ohms, 2 watts.
- R₇ — 5 megohms, $\frac{1}{2}$ watt.
- R₈ — 75,000 ohms, $\frac{1}{2}$ watt.
- R₉ — 50,000-ohm potentiometer.
- R₁₀ — 25,000 ohms, 2 watts.
- R₁₁ — 0.1 megohm, $\frac{1}{2}$ watt.
- R₁₂ — 20,000 ohms, $\frac{1}{2}$ watt.
- R₁₃ — 0.5 megohm, $\frac{1}{2}$ watt.
- R₁₄ — 2000 ohms, 1 watt.
- R₁₅ — 10,000 ohms, 5 watts.
- L₁-L₆, inc. — See coil table.
- L₇, L₈ — 15 henrys, 100 ma.
- L₉ — 15 henrys, 50 ma.
- J₁, J₂ — Closed-circuit jack.
- J₃ — Open-circuit jack.
- RFC — 2.5-mh. r.f. choke.
- S₁ — S.p.s.t. lock switch.
- S₂, S₃, S₄ — S.p.s.t. toggle.
- T₁ — Filament transformer, 6.3 volts, 2 amp.
- T₂ — Power transformer, 500 volts, 150 ma., with 5-volt rectifier winding.
- T₃ — Receiver power transformer, 230 volts, with 5-volt rectifier winding.



Looking into the top of the r.f. cabinet from the rear. The receiver is along the left-hand edge of the chassis, 6L6 amplifier in the center, 6N7 oscillator-doubler at the right.

power unit is just about as lacking in complications as possible.

Receiver

The receiver takes up a space of 7×3 inches, which makes it a pretty compact job. The circuit is a regenerative detector, a 6J7, and one stage of audio, a 6C5, conventional in all respects — and, incidentally, the only receiver I ever built that worked “right off.” In operation the detector regeneration is moderately smooth, and the output to a headset is pretty good. The drawback is, of course, the lack of selectivity. In part this can be remedied by using a 2-foot vertical rod for an antenna but, at best, this method is a poor compromise. The loss of signal amounts to about two S's, average, compared with a 66-foot antenna. On strong signals this loss doesn't matter, but on the weaker ones it's the difference between copying and not copying. This doesn't look so bad, however, when the compactness and price are considered. For seven dollars and thirty-five cents it's hard to beat. Also, when the QRM isn't too tough it really drags them in on a long wire. At the present time it's used as a kind of auxiliary receiver, but more about that later.

R.F. Section

Before building the r.f. section I listed the features I wanted. Some of them were as follows: the transmitter had to work all bands; the crystals, for economic reasons, had to be 80-meter units if possible; the power ought to be 40 watts or so, and break-in keying was essential. When I compared these requirements with the $8\frac{1}{2} \times 7$ chassis space, things looked dark for the home team. After trying a good many circuits and layouts, however, the present one was evolved and it covers all of the requirements nicely. A 6N7 is used as an oscillator and doubler or just an oscillator. A 6L6 is used as a straight final or doubler. Regeneration was tried in each triode section of

the 6N7, but it proved a little too hard to keep tuned under portable conditions and then, too, it's too much trouble pulling the rig apart every so often. Straight triodes are simple and easy to tune. The number of stages is changed by means of the coils and socket wiring. If a coil is not plugged into a socket the stage doesn't take current because there is no voltage on that triode. When working straight through with an 80-meter crystal the first triode is not used and the second triode becomes the oscillator. Thus only the stages needed are used.

The voltage supplied to the 6L6 runs about 500 under load, and the oscillator voltage is taken off at the input plug. Since the load, so far as the oscillator is concerned, is not constant because both triodes are not always used, it is not advisable to use a voltage divider system to lower the 500 volts to 300 or so for the 6N7. Consequently each triode of the 6N7 is treated as a separate stage and two 15,000-ohm dropping resistors are used for that purpose. Actually the voltage varies, because of the varying load on the power

COIL DATA

Band	L ₁ (6N7)	L ₂ (6L6)	L ₃ (Ant.)	L ₄ (Recvr.)	Tap*
1.75 Mc.....	66	71 c.t.**	59	63	4
3.5 Mc.....	28	42 "	21	31	1 $\frac{1}{2}$
7 Mc.....	13	25 "	9	15	$\frac{3}{4}$
14 Mc.....	7	10 "	4	7	$\frac{1}{2}$
28 Mc.....	3 $\frac{1}{2}$	5 "	2	4	$\frac{1}{2}$

* Turns measured from ground end. A quarter to half turn variation may be expected with different layouts and components; the tap should be adjusted for smooth regeneration.

** Partly layer wound and shunted by a 50- μ fd. condenser in coil form.

L₃ and L₄ consist of two or three turns, with link, arranged to fit over L₂ and L₅, respectively. Adjust for optimum power transfer. Antenna coils are for use with a single-wire fed antenna. Other types of antennas may require considerably different values.

All coils wound with No. 20 d.c.c. on 1 $\frac{1}{2}$ -inch diameter forms.

transformer, and the 6N7 is supplied with anywhere from 250 to 300 volts. This isn't very important, however, because 300 volts isn't too much and 250 volts still drives the 6L6 plenty hard.

A little care must be taken to see that the coil sockets are properly wired. The sockets are five-prong so that the crystal holder will fit only in the right holes and not across the high voltage. Bakelite sockets are used for the 6N7 and the first-triode crystal and coil, with isolantite the rest of the way. The first two stages are tuned by air trimmers, as the photographs show. The trimmers are insulated by drilling the chassis holes to allow an insulating space and running screws through the chassis into the isolantite-insulated nuts in the trimmer; not very fancy, but it works. The tuning is done with a 6-inch bakelite rod, filed to a wedge at one end and with a knob fastened on the other end.

The output of the 6L6 is about the same either straight-through or doubling. The neutralizing condenser is of the micrometer type, as the photograph shows, and once set it isn't touched. An 807 was tried and it worked very well; however, more than that had to be considered. The height of the 807 made it necessary to underslung the socket and that cramped the wiring. Also an 807 costs four times as much as a 6L6 so the good features of an 807 were sacrificed in favor of the cheaper and smaller metal 6L6. A glass 6L6 works well, too, but the problem of size rears up again. It requires an underslung socket and the glass doesn't dent well. The 6L6 I'm using now has two good-sized dents in it and the key pillar is broken off at the base so that the glass inner base sticks out, but it still works as well as ever. The screen voltage is obtained through a dropping resistor of 10-watt rating; a five-watt tends to smoke a little. All of the condensers possible are paper 600-volt units; micas are used for coupling but other than those the cheaper papers are used. The blocking condenser in the final is composed of two of these paper condensers in series. The final tuning condenser is 50 $\mu\text{fd.}$, double spaced, and is mounted on a $\frac{1}{2}$ -inch stand-off to insulate it from the chassis.

Break-in keying is accomplished by keying the cathodes of both the final and the oscillator. The two jacks on the front panel are for the keying, one in the oscillator and one in the final. The jack in the 6L6 cathode is used

only for tuning. The keying plug goes in the oscillator jack and this keys both stages as the diagram shows. A dummy plug goes in the final jack to open the final cathode when tuning the 6N7, but it is pulled out when operating. With very balky crystals, however, it may be necessary to key in the final jack. Shielded microphone cable is used for keying leads and although no filter is used the clicks aren't strong enough to be bothersome.

Coils

All of the coils in the transmitter and receiver are wound on Hammarlund SWF forms with No. 20 d.c.c. This is to standardize the coils so that they are interchangeable if necessary. The 160-meter 6L6 coil has a 50 $\mu\text{fd.}$ mica¹ condenser mounted inside the form to provide enough capacity to hit the band. The 6N7 coils are wound alike so that they may be used in either triode. The antenna coils are wound on old forms I've had lying around for years. They are 2 inches in diameter and made of wood. A word about the antenna coils. Every antenna requires different tuning and the antenna coils require rewinding every time a radical change in antenna is made. At the present time I'm using a 134-foot single-wire fed antenna and the coil specifications are for this antenna. If a Zepp is used the coils will be quite a bit larger. Labels in the tops of all forms keep the coils from getting into the wrong sockets.

Antenna Coupler

The antenna coupler is electrically conventional but mechanically custom built, as shown in one of the photographs. Two one-inch standoff insulators, with a center-threaded mounting hole and jack top, are used. They are mounted in the

(Continued on page 74)

¹ To be on the safe side an air condenser is recommended. A Hammarlund APC50 could be mounted inside the form. — Ed.

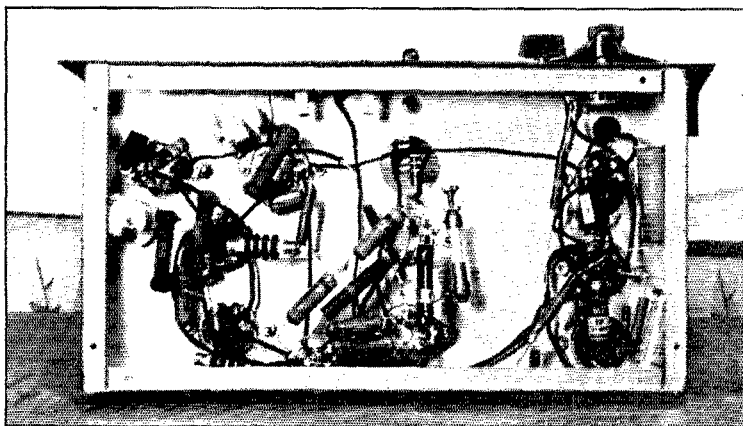

Bottom view of the r.f. chassis. In this view the receiver is at the right.

A Low-C Electron-Coupled Oscillator

Modified Tank Circuit Design in the E.C.O.

BY E. O. SEILER,* W8PK

A somewhat different approach to tank circuit design for maximum stability, along lines which may eventually find wide application in v.f.o. units.

IN THE past few years numerous articles have been written about variable frequency oscillators, most of them describing some type of e.c.o. using a high- C tuned circuit for frequency control. However, last fall after reading over an article on a low- C high-stability oscillator,¹ experimental work was started to see whether the old high- C gear could be modified and improved. The high- C circuit was fairly stable once operating temperature was reached, but the drift was considered too great during the warm-up period.

Results with the modified set-up were discouraging. The arrangement tried was one mentioned in the article, consisting of a 6V6 in the plate tickler circuit. For some reason or other it refused to oscillate, and when after several circuit changes and trials there were still no oscillations the whole idea was given up — for two weeks. Then some figuring with the aid of pencil and paper produced a circuit similar to the one shown in Fig. 1. This new version began to produce results. It is essentially a Colpitts oscillator, with the tube loosely coupled to the tank circuit by means of the capacitive voltage divider $C_2C_3C_4$.

* Box 114, East Bloomfield, N. Y.

¹ Roberts, "The Limits of Inherent Frequency Stability," *RCA Review*, April, 1940.

At this point it might be well to review briefly the principles on which this type of circuit is based. The factor which determines the frequency stability of an oscillator is the effective Q of the tank circuit, not the L/C ratio as such. In ordinary circuits, where the tube elements are directly across the tank, the load resistance represented by the tube is low enough to be the principal factor in determining the effective Q , rather than the inherent resistance of the tuned-circuit components. When this is the case, a high effective Q can be secured only by using high C in the tank circuit, a method which also is beneficial in reducing the effects of small variations in tube capacities on the oscillation frequency. However, the Q also can be made high by using loose coupling between the tube and frequency-determining tank so that the effective load resistance, as looked at by the tank, is much higher than is the case when the tube is directly connected to the tank. Thus a higher L/C ratio can be used, which is beneficial in at least two ways when the method is properly applied: A tank circuit of higher inherent Q can be obtained, since the Q of the coil, within reasonable limits, increases as its inductance is increased; and the circulating current is reduced, thereby reducing heating effects. The Colpitts circuit as shown in Fig. 1 retains the high capacities across the tube elements, thus giving the capacity "swamping" effect of the ordinary high- C circuit.

Practical Circuit Constants

Referring to Fig. 1, it may be noted that at no time is the total capacity across L_1 greater than

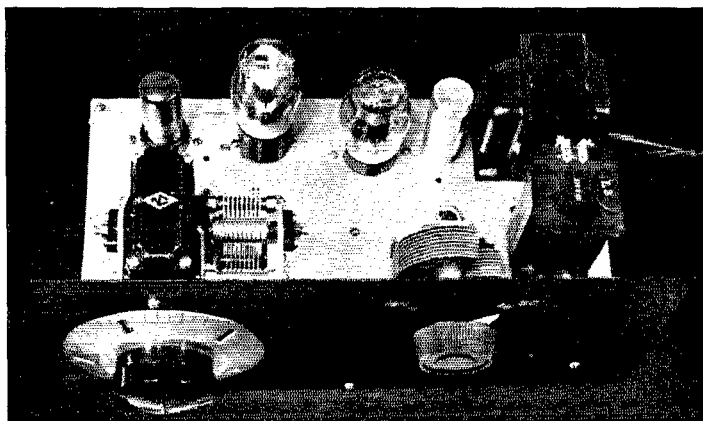

W8PK's variable frequency control unit, using the oscillator circuit described in the text. The power supply occupies the right-hand end of the chassis.

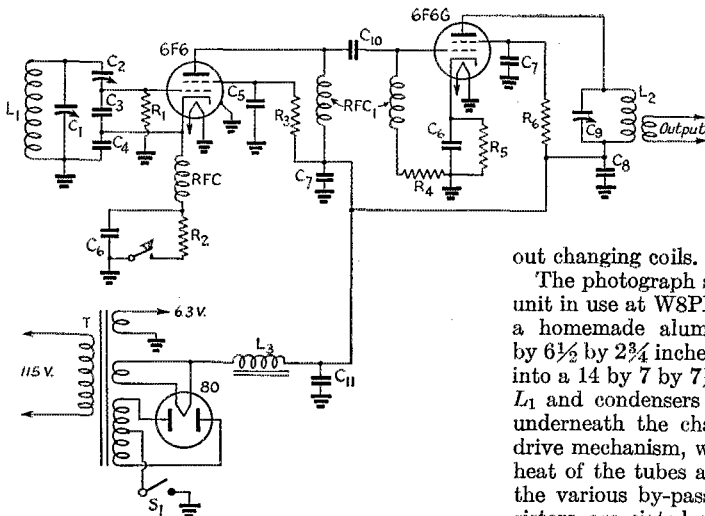

Fig. 1 — Circuit diagram of the e.c.o. unit.

- C₁ — 150- μ fd. variable (National PW-1).
- C₂ — 100- μ fd. variable (Hammarlund ABC-100).
- C₃ — 525- μ fd. silvered mica (Eric).
- C₄ — 1200- μ fd. (525- μ fd. and 460- μ fd. Eric silvered mica and 215- μ fd. Eric Ceramicon, all in parallel).
- C₅ — 0.05- μ fd. paper, 400 volts.
- C₆ — 0.01- μ fd. paper, 400 volts.
- C₇ — 0.003- μ fd. paper, 400 volts.
- C₈ — 0.02- μ fd. paper, 400 volts.
- C₉ — 350- μ fd. variable.
- C₁₀ — 50- μ fd. mica.
- C₁₁ — 8- μ fd. electrolytic, 450 volts.
- R₁ — 50,000 ohms.
- R₂ — 1000 ohms.
- R₃ — 18,000 ohms.
- R₄ — 25,000 ohms.
- R₅ — 450 ohms.
- R₆ — 15,000 ohms.
- L₁ — 44 turns No. 23 s.c.e. on 1½-inch diameter form.
- L₂ — 35 turns No. 23 s.c.e. on 1½-inch diameter form; output coil 5 turns.
- L₃ — 15-henry choke.
- RFC — 2.5-mh. r.f. choke.
- RFC₁ — B.c. type universal-wound chokes (2.5-mh. units may be used).
- T — Power transformer, 250 volts, 75 ma.
- S₁ — S.p.s.t. toggle.

250 μ fd., which is low C considering that the oscillator operates in the 1.75-Mc. band. The 100- μ fd. variable, C_2 , controls the coupling between the tube and tank. It may also be used for band setting, but the circuit will stop oscillating if the capacity is reduced too much. The coil L_1 should be pruned so that nearly all the capacity of C_2 is in use. The main tuning condenser, C_1 , is a 150- μ fd. variable attached to a PW drive unit with micrometer dial. Tuning is fairly sharp without additional provision for bandspread, so that some sort of vernier dial is useful. In this case the band from 1750 to 2000 kc. is spread over 155 divisions on the dial.

Aside from the tank circuit, the remainder of the e.c.o. unit is more or less conventional and

needs little special comment. The oscillator is choke-coupled to the buffer, and the buffer plate tank is tuned either to the fundamental or the second harmonic of the oscillator frequency, using a 350- μ fd. tank condenser to cover both bands with-

out changing coils.

The photograph shows the layout of the v.f.o. unit in use at W8PK. The parts are mounted on a homemade aluminum chassis measuring 13 by 6½ by 2¾ inches, and the whole assembly fits into a 14 by 7 by 7½-inch steel cabinet. The coil L_1 and condensers C_2 , C_3 and C_4 are mounted underneath the chassis directly below the PW drive mechanism, where they are away from the heat of the tubes and power supply, along with the various by-pass condensers, chokes and resistors associated with the circuit. The buffer plate coil, also below the chassis, is isolated from the oscillator section by a baffle shield. The usual constructional precautions should be taken to mount the wiring and components solidly so that the effects of vibration on the oscillator frequency will be minimized.

The Q of any tuned circuit coil is affected by the shielding. In this unit the oscillator coil is enclosed on all sides except the bottom by the aluminum chassis and interstage shielding partition. When placed in the cabinet the oscillator coil is completely enclosed in metal, but the sheet steel of the box affected the Q to such an extent that the oscillator would not function. This difficulty was overcome by placing a sheet of copper on the inside bottom of the box.

Stability

Fig. 2 shows a typical frequency drift curve of the oscillator, starting from room temperature. Several similar frequency drift runs were made over a period of a week, and in all cases the drift for a half hour's continuous run was from 300 to 400 cycles at 3540 kc. The frequency change resulting when the plate supply voltage was varied from 225 to 170 volts was 50 cycles. It should be noted that no voltage stabilization

(Continued on page 78)

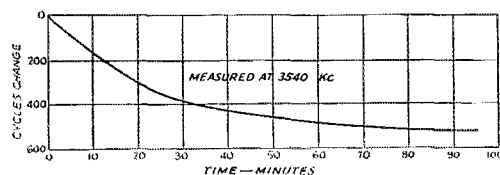

Fig. 2 — Typical frequency-drift curve, obtained by heating against b.c. station harmonic and measuring frequency change with a calibrated audio oscillator.



U. S. A. CALLING



CIVIL SERVICE POSITIONS

THE United States Civil Service Commission is seeking a large number of qualified persons for a considerable variety of technical positions in numerous government agencies, chiefly associated with the defense effort. A general outline of some of these positions is given below. It will be noted that each group of positions bears an announcement number. Full particulars and necessary application forms may be had by a visit to the secretary of the Board of U. S. Civil Service Examiners at any first- or second-class post office, except in the following cities where one should call at the U. S. Civil Service District Office: Atlanta, Boston, Chicago, Cincinnati, Denver, New Orleans, New York, Philadelphia, Seattle, St. Louis, St. Paul, San Francisco, Honolulu, Balboa Heights, San Juan and Washington (main office). Appointments in all cases are competitive, but written examination is not required. Competitors are rated on their education and experience and fitness, on their own sworn statements, subject to verification by the Commission. All must be citizens of the U. S. All applications require the execution of what is called Form 8 and an application card, Form 4006, with occasional requirements of supplementary forms — all of which must be filed with the U. S. Civil Service Commission at Washington. The required qualifications vary between positions, and indeed between different pay grades in the same general category of position, so that we recommend personal calls at the Commission offices or post offices and a careful study of the announcements, identified by the numbers below. In major outline:

Radio Mechanic-Technician, Announcement No. 134, open only until November 6th. Basic pay, \$1800 a year; senior radio mechanic-technician, \$2000; principal ditto, \$2300; assistants, \$1620; juniors, \$1440.

Ages, 18-53, except veterans. Varied duties in connection with construction, maintenance, overhaul and repairs, including all types of modern radio communication equipment. Great shortage of qualified men exists. Rating depends upon extent of training or experience but, in general, applicants must show one or more of the following: paid experience in technical radio work; technical study in residence at a radio school; resident study in radio in a school of engineering or technology; completion of an approved Defense Training Course in radio. Only limited credit for BCL repair work or other restricted routine. Application also requires Supplemental Form 3785.

Technical and Scientific Aid, Announce-

ment No. 133, \$1800. Senior ditto, \$2000; assistants, \$1620; juniors, \$1440. Open until June, 1942, to both men and women; age limit, 53.

Many government agencies are seeking aids to do research and testing. Duties are to perform subprofessional technical and scientific work, conduct tests, make appropriate calculations, etc. Applicants must show 14 units of high-school study unless additional experience is substituted for it. In addition, they must have had paid technical or scientific experience of high quality. Approved Defense Training Courses may be substituted for part of the experience, as may appropriate college study. The tabulation of alternative credits to qualify for these positions is too complicated to reproduce here; the announcement should be inspected. Application requires also Supplemental Form 3630.

Engineer, Announcement No. 69, \$3800 a year. Also grades of principal, \$5600; senior, \$4600; associate, \$3200; assistant, \$2600.

The duty of Engineers is to perform, or supervise the performance of, professional engineering work in design, construction, survey, research and investigation. Responsibilities and difficulties are commensurate with the grade. The basic experience requirement varies with grade from two to seven years of professional engineering experience. Applicants must have successfully completed a four-year course leading to bachelor's degree in an institution of recognized standing or be able to substitute additional experience, year for year. Typical requirements for the grade of Engineer: "Five years of progressive, professional engineering experience . . . including at least two years of difficult, important, and responsible work which has demonstrated the applicant's resourcefulness and initiative, a considerable knowledge of engineering, the ability to perform work of greater-than-ordinary difficulty, and professional attainments of a high order." Assistant Engineer requires only two years of professional experience, while a Principal Engineer needs seven years of broad and progressive experience. Age limit, 60.

Engineering Draftsman, Announcement No. 28, \$1800. Also chief at \$2600; principal, \$2300; senior, \$2000; assistant, \$1620. Various optional branches, including radio.

Applicants require 14 units of high-school study unless they can substitute extra drafting experience beyond the normal requirement; which is one year of elementary drafting training or experience, plus from one to five years of practice in the elected branch. Age limit, 55, except for veterans.

LOOKING FOR ADVENTURE?

THE response of amateurs to the Army and Navy's call for trained men for radiolocation work has been excellent and many have been commissioned or are in the process of being commissioned as electronic specialists. It can now be told that the duties under these commissions involve eight months' service in England, four months to be spent in the observation of radio instruments of new invention, about which little is known in this country, and four months in actual work on these instruments with the RAF.

The information derived from this study and training will not be found in textbooks and will be invaluable in later life. Upon their return from England, the officers will teach others in this country what they have learned, and after the war will be in great demand because of their special knowledge and experience. It is predicted that these instruments will be widely used on commercial and military ships and planes.

This is an extraordinary and unique opportunity for qualified men who have the spirit of adventure, the desire to learn, and the will to serve. If you haven't already applied to George W. Bailey, National Research Council, 2101 Constitution Avenue, Washington, D. C., do it now!

MARITIME OPERATORS

IN JUNE *QST* we had a feature article on the school for maritime operators at Gallups Island operated by the Coast Guard on behalf of the Maritime Commission. Their proposition sounds too good to be true, but we wrote that story ourselves and we know the school is just as good as it sounds — marvelous free training for the right young fellows. If you are interested in maritime operating, dig down June *QST* and read it again.

FREE TECHNICAL SCHOOLING

UNDER huge appropriations made available by Congress through the U. S. Office of Education (part of FSA), innumerable colleges and universities throughout the land are making available free technical courses in an unbelievable variety of subjects associated with what is called Engineering, Science and Management Defense Training.

Regional differences in defense training needs and in facilities for instruction result in wide variation in the courses offered. Some are designed to prepare students for a new field of activity; others to fit those already employed in defense work for better assignments. Some require the full time of the student; others are given after working hours for those who are employed. Courses may vary from a few weeks to several months. Classes may meet on the campus or elsewhere; many institutions provide instruction in a number of cities simultaneously. Subjects range from basic courses

to highly refined specialties, with considerable in the field of radio.

The government reimburses the schools for the cost of instruction, so no tuition or other fees are required of students. Students must, however, provide their own subsistence and purchase their textbooks and minor supplies. The schools themselves select and admit the students, so that applications for admission and requests for further information are handled direct with the school concerned. To be admitted, students must be *employable* in defense work and must meet the established prerequisites for the course — which vary with the complexity of the subject and the purpose of the training. In general, a high-school education is the minimum qualification, while certain subjects require from one to four years of study in an engineering college. While no guarantee is given that a student will receive employment, college and public employment facilities are utilized in placing him.

We have before us a list of 58 institutions in 30 states offering some hundreds of courses in the ESMDT plan, ranging the whole breadth of engineering and science. Courses in engineering drawing and engineering mathematics appear frequently. We have space below to list only the courses dealing specifically with radio. In this listing an asterisk means that the course requires the full time of the student; those not so marked are part-time courses:

University of Alabama, Radio Technology*; University of California, Radio Communication & Underwater Sound; University of Kansas, Elementary Radio Engineering; Harvard University, Electronics & Cathode-Ray Tubes*; Rensselaer Polytechnic Institute, Radio Engineering; University of Pennsylvania, Radio Engineering Problems; University of Pittsburgh, Radio Maintenance; Agricultural & Mechanical College of Texas, Radio Communications*, Radio Engineering*; University of Texas, Electronics and Radio; University of Virginia, Fundamentals of Electrical Engineering, Industrial Electronics. We believe that a recently-offered course in Electronic Physics at the University of Ohio is also part of this program.

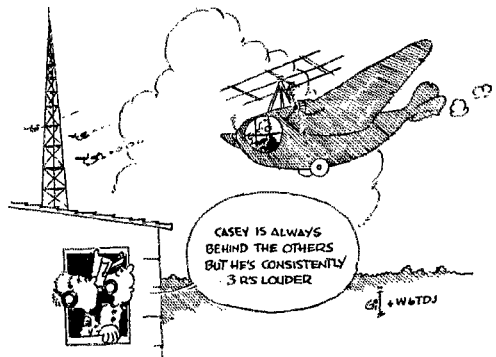

More Meaning in Your Signal Reports

Practical Information on S Meters, Their Circuits and Use

BY S. GORDON TAYLOR,* W2JCH

THE everlasting urge to change and improve his signal makes the average ham continuously and vitally interested in signal-strength reports. This being the case, the S meter has come to play an important role in activities on the air, yet reports from other stations based on S-meter readings really mean very little in themselves. The reason for this is that two receivers of different makes or models, operated side by side and under identical conditions, may give readings several S's apart on the same signal. To aid both in giving better reports and in interpreting more accurately the reports received, this article presents data and a discussion covering S meters and their use.

It is generally recognized that the S meters on different receiver models vary in their calibrations. Some of them are "scotch," others over-optimistic. To determine the extent to which this is true, and to learn more about their general characteristics, laboratory measurements were made on a number of the models now in popular use and on other such models data were obtained from the manufacturers' literature.

The S Unit

Before presenting some of the information gained in this way it may be well to emphasize the fact that the S unit itself is not standardized, either quantitatively or relatively. Originally the S scale depended upon the individual ear for its values, and with the introduction of the meter it was up to the individual receiver manufacturer to establish his own calibration values. Just as individuals disagree on their ear judgment of an S9 signal, so manufacturers disagree to-day, largely because there are some rather critical design and production problems in connection with their S meters and meter circuits. It is therefore quite understandable that there should be discrepancies in the readings provided by different receivers for the same signal input.

The extent of these differences is shown by the following figures taken from measurements on a group of ten receiver models. To drive each meter to the S1 level required inputs varying from such a small fraction of a microvolt that it was below the level of the noise developed in the laboratory

setup, to a high of 5 microvolts. To obtain an S5 reading on each receiver required values of input ranging from 2.1 to 55 microvolts. For an S9 indication one receiver required an input of only 14 microvolts while another just reached S9 on an input of 6800 microvolts! The others accomplished this on signals of 20, 50, 65, 74, 100, 110, 200 and 460 microvolts.

Another basis for comparison might be in the number of decibels per S point. But here again there is wide divergence as shown in the chart of Fig. 1, where the decidedly long scale of the Hallicrafters SX-23 is in wide contrast to the short scales of the SX-25 and the HRO.

Great as these variations are, they are probably no greater than those in reports given by ear. An argument which took place several years ago between two hams supports this. They had just incorporated meters in their home-built receivers and were in the process of calibrating them. It was the contention of one that S9 should be the point to which the strongest signal heard would drive the meter, and in his case the strongest signal was that of a 50-kw. broadcast station about 50 miles distant. The other insisted that the S9 level should be that at which every syllable of every word is just completely understandable. In view of his country location this probably meant a signal input of well below 50 microvolts. Each stuck to his guns, with the result that it was not unusual to receive a "Q5-S2" report from the first ham, while "S9-plus" signals were the rule from the second.

Using the Charts

Be that as it may, we are living in the present and surrounded by meter-equipped commercial receivers. The question is, how can the S meter

Amplifying information presented in an earlier article, this dope will help reconcile S-meter signal reports from different current models of receivers. If your receiver has no S meter, you'll be interested in the circuit and calibration suggestions offered.

* 2505 Aqueduct Ave., New York City.

be employed to provide more definite and helpful signal report information?

The charts of Fig. 1 and Fig. 2 have proved to be extremely helpful. In this connection it may be well to point out that while the meter values for different makes and models of receivers vary greatly, different receivers of the same model will usually show almost negligible differences so long as they are in normal operating condition. Thus the scales of Fig. 1 will apply reasonably well to existing receivers of these models.

Some of the scales in Fig. 1 start at S0 while others start at S1, S2 or even S3. In the measurements the practice was to consider S1 as the starting point of the scale. Signal values below this point are seldom usable ones. Four of the scales start at S0 because they were taken from a similar chart in an earlier article.¹ Where scales start at S2 or S3 it is an indication that the signals required to drive these receivers to their lowest S values were too small to measure accurately. This does not necessarily mean that the sensitivity of these receivers exceeds that of others, but simply that their S meters start indicating at lower signal values. In fact, the scales of Fig. 1 indicate nothing about the relative sensitivity of any of the different models.

One useful feature of Fig. 1 is the information it gives the owner of any one of these receivers

¹ Taylor, "Checking Beam Antennas with the S Meter," *QST*, April, 1939.

concerning the range of his meter as compared with that of others. The second use of the chart is in the means provided for more accurately interpreting reports received from other stations. If the front-to-back ratio of a beam is being checked, for instance, and the signal reports are given in terms of S readings, reference to the charted scale for the reporting receiver will permit the report to be instantly translated into decibels. This in turn can be converted to power ratios if desired, by reference to Fig. 2. The effectiveness of different transmitting antennas can be determined in like manner by switching from one antenna to the other and going through the same conversion routine after the reports have been received from the other station.

The chart of Fig. 2 is a duplicate of one published earlier¹ and is used by the author for quick conversion of decibels to voltage or power ratios and vice versa. In addition to these three scales it also includes the S calibration of the receiver. The reader can readily substitute the scale of his own receiver, copied from Fig. 1.

With this arrangement one can give reports not only in S units but in decibels, voltage ratios or power ratios. In checking another's beam, it is obviously more helpful to tell its owner that, for example, the back radiation is down 27 db. as compared with the head-on signal, or that the difference represents a power ratio of 500 to 1, rather than simply telling him that his signal is

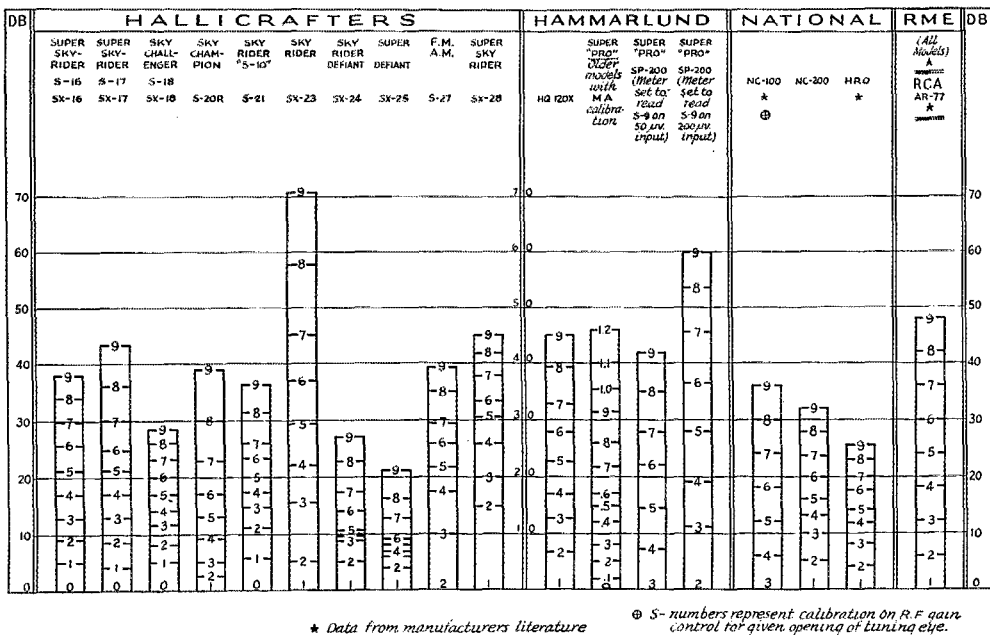
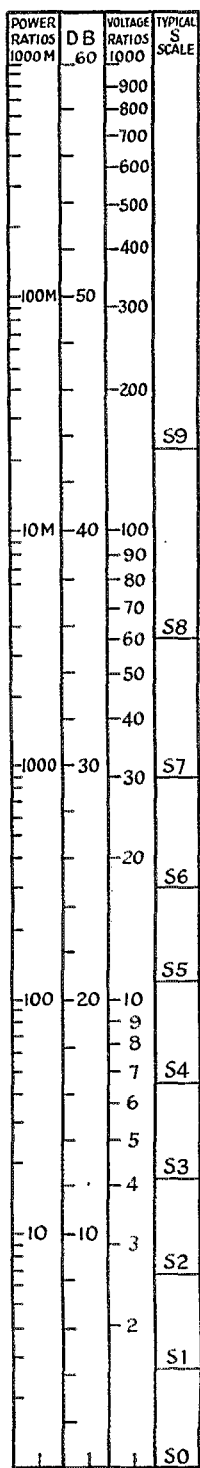

Fig. 1 — Decibel values for S meter scales of a number of standard communications receivers now in common use. The graphs will apply with reasonable accuracy to any receiver of the indicated model providing it is in normal operating condition.



"S9 off the front and S4 off the back."

There are other ways in which reports to others can be made more useful. One of these is to relate your report to some definite value that will give it more meaning. Thus a statement to the effect that the signal is 25 db. above the local noise level, or 10 db. below a 500-watt local broadcast station, etc., lends greater value to your report. As pointed out earlier, an S9 report may mean anything from a few microvolts to several thousand at the receiver input. Even with the information of Fig. 1, a straight S report will have little meaning so far as quantitative values are concerned. But if the station has been given reports before from the same receiver, the chart will enable him to determine and evaluate any improvement that may have resulted from changes in the rig or antenna since the earlier reports. This assumes, of course, that the reporting station is close enough to eliminate effects of skip or other variables.

"Scotch" or Flattering

It is of interest to have some idea as to which receivers are inclined to give "scotch" reports, which ones are flattering, and which are about average. This cannot be determined by reference to the scales of Fig. 1 for the reason that these scales show the ratio of signal strengths covered

Fig. 2 — Substitute the db. scale for your own receiver (plotted from Fig. 1) in place of the "Typical S Scale" shown in the last column and you will have a rapid conversion chart enabling you to convert different S values instantly into equivalent terms of decibels, power ratios or voltage ratios.

A.V.C. Controlled I.F. or R.F. Tube

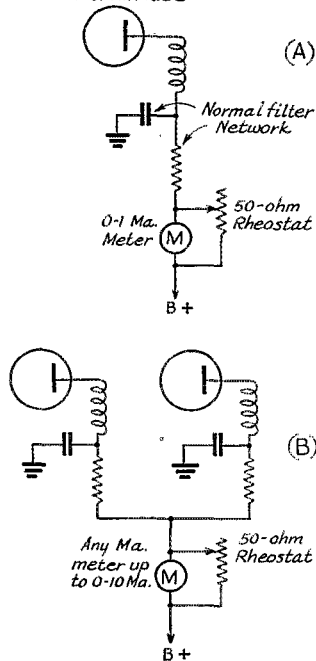

Fig. 3 — Two simple ways in which a milliammeter can be connected into an existing receiver circuit to serve as an S meter. In (A) the B-plus lead to an a.v.c. controlled tube is opened and a sensitive milliammeter inserted with a 50-ohm variable shunt to adjust the meter sensitivity to the required value and thus serve as the zero adjustment. Where the available milliammeter is relatively insensitive, with a range of 0-10 ma. for example, it may be necessary to insert it in the supply lead to two tubes, as at (B), in order to drive it to full scale or S9 position.

by a receiver's S range and have nothing to do directly with quantitative signal values. Thus two receivers may have an S-scale length of 40 db. and yet offer widely different reporting characteristics. If one of them shows S1 at a signal input of 0.2 microvolts then a 20-microvolt signal would push it to the S9 level and its reports would be highly flattering. If the other indicated a 2.0-microvolt signal as S1, then a signal 40 db. higher would be 200 microvolts which would be a definitely husky one as ham signals go. Reports given on the basis of this receiver would therefore be of the "scotch" variety.

Actual measurement data on the different receivers, or extensive first-hand experience with them, serve as the best guides in classifying the different models as to the "scotch" or otherwise tendencies, and it is upon these that the following classification is offered:

Hallicrafters	SX-17	Average
"	SX-18	Flattering

Hallcrafters	S-20	Flattering
"	S-20R	Very scotch
"	S-21	Scotch
"	SX-23	Very scotch
"	SX-24	Flattering
"	SX-25	Flattering
"	S-27	Scotch
"	SX-28	Scotch
Hammarlund	HQ-120X	Average
"	SP-200	Average *
"	SP-200	Scotch **
National	NC-100	Average
"	NC-200	Scotch
"	HRO	Flattering

* When S meter is adjusted to read S9 on a 50-microvolt input. This is the adjustment with which these receivers are shipped.

** When adjusted to read S9 on 200-microvolt input.

In general, reports from any of these receivers can be interpreted in the light of the classification shown, with the exception of the SP-200. This receiver is unique in that the meter adjustment provides for variation of the S9 level rather than the more usual S0 level. Thus the owner can make the S9 level anything he desires and whether reports received are scotch, average or flattering will depend on the individual adjustment.

Meter Adjustment

The great majority of meter-equipped receivers provide the means for adjusting the zero position of the meter with no signal coming in. Too often owners don't bother to check this adjustment from time to time; or if they do make occasional readjustments, fail to disconnect the antenna when so doing.

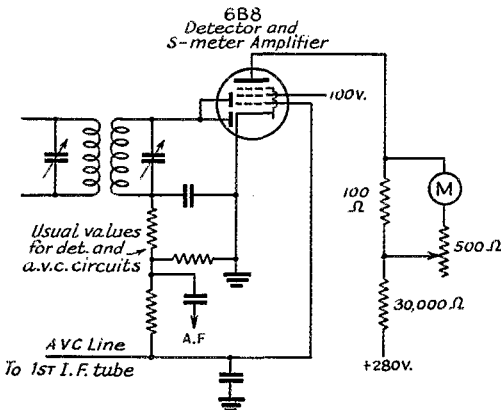

Fig. 4 — A more complicated meter circuit utilizing a separate tube (or section of a multi-purpose tube) as a meter amplifier. In effect this arrangement constitutes a v.t. voltmeter connected across the a.v.c. line. By the proper choice of voltages the plate-current characteristics can be adjusted to spread the S scale well out over the meter face.

Warning!

Amateur Traffic Must Not Disclose Ship Locations

We have just received a sharp warning from Washington about the handling of messages whose addresses or texts disclose the location of naval vessels. Such information must not be heard on the air. It is of great importance to our future that all traffic handlers stay on the alert to prevent divulging ship locations either by themselves or by other amateurs.

This warning is confined to the matter of ships; it does not apply to traffic to Navy personnel at shore stations or those who have a P. O. box number or other address that does not show the ship location. Messages to men aboard ships may still be handled if addressed in care of the ship in care of the postmaster at either New York or San Francisco — but not at any other city. Either of these postmasters will forward mail to the ship, wherever it is located. But this means that the final receiving amateur must mail the message, and that from NY or SF it will go only by mail. All too frequently this will be much slower than direct all-mail. We are reluctantly forced to conclude that, except in cases where the haul across the continent is important, we ought to discourage traffic to Navy shipboard personnel and advise the senders to use mail or wire.

Refuse ship messages addressed other than care postmaster at either New York or San Francisco!

More than that, keep these subjects out of your ragchews. Ship sailings, troop movements and military data have no place on the air these days.

With the majority of receiver models now in use changes in line voltage may seriously affect the meter at the low end of the scale. If it is adjusted to read S0 at a time when the line voltage is high, for instance, then when the line voltage drops (as it does in many localities during the early evening) the no-signal position may become S3 or S5 or almost any other up-scale value. In most cases, the signal input required for an S9 indication will not change appreciably with line voltage. But if the no-signal position of the meter is S5,

(Continued on page 78)



WHEN a licensed amateur's draft number comes up and he reports to his local board, he is usually assigned to duties with the Signal Corps. This often means a few weeks' training at Fort Monmouth, N. J., and this month we find there a goodly group of amateur conscripts including Green, 8VSO; Stricklin, 4GJG; Striepling, 9GPH; Elmer, 7DUJ; Wallen, 1MKV; Norr, 9VJP; Rogers, 6KJD; Vass, 6PYE; Kiburis, 2GDW; Walker, Jr., 1NEG; Roeder, 2DMW; Block, 2FHD; Corrigan, 2JLI; Bales, 6DRU; Lynaugh, 9LKR; McManis, 5ITY; Westfall, SCAF; Conrad, 8MVZ; Schiffman, 2MPM; Antweiler, 8OPU; Lee, 7HOD; Hein, 8LXE; Windmuller, 8UMK; Rittmann, 3JLT; Adamson, 6QHP; Schiffin, 2EDI; Quirk, 1LPI; Kelly, 1KPS; Pfeffer, 2AIM; Schmader, 8GJD; Grant, 8IEU; Matheny, 9RLU; Leeds, 3CRK; Ferguson, 9UTK; Bogas, 2MFH; Zane, 3GUJ; Zuloff, 2KPP; Witchey, 8OKD; Zeppenfeldt, 2NOT; Josselyn, 1ICT.

At Fort Monmouth there are a number of officers, many from reserve status, directing the training of these recruits. Captains Gold, ex-WOBD of MacMillan Expedition fame, and



One of amateur radio's bright stars in the defense picture is Lieut. Commander John L. Reinartz, USNR, for the last few years on active duty at Naval Communications at Washington. John was right out in front in the practical amateur development of high frequencies, leading the way from band to band. He developed the first good amateur c.w. receiver and the transmitter circuit used in the first amateur trans-Atlantic communication, and has been a frequent contributor to QST. He is now W3IBS at his home in Arlington but probably gets a greater kick out of the fact that he is the licensee for W3USA, which is NAA's transmitter in the ham bands for assisting in the continuing relations between Naval Communications and amateurs under John's direction.

SERVICE RECORDS WANTED

We are gathering data on the participation of amateurs serving with our military forces in communications work. Have we your name on our list? A postcard with the below-mentioned dope will do the job.

- (1) Are you a Selective Service conscript, a volunteer, or a reservist on active duty?
- (2) For how long a term are you serving?
- (3) Is your service in the Army, Navy or the Marine Corps?
- (4) To what outfit or organization are you assigned?
- (5) Location; where is your organization stationed?
- (6) What rank or rating do you hold?
- (7) What is your present radio duty assignment?
- (8) Were you previously a member of NCR or AARS?
- (9) Give your name and your home call.

We have available a number of postcard-size registration cards for this purpose, so if you are located where there are a large number of amateurs and would be willing to arrange the distribution of these cards, we'd be glad to send you as many as you request.

Shidel, 9CIU, are assistant officers in charge of the radio division. Captains Hertzberg, 2DJJ, Lts. Kodama, 2GAK, Kierstead, 3IDU-2OCR, and Angster, 2NLC, prepare training literature for the use of students. Lts. Paul, 9FPF, and Stover, 5YF, are in the electronics training group. Other officers are Lts. Buck, 7BSD; Heitman, 6PHP; Price, 8JNZ-2OEM; and Capt. Brown, 2MNO.

There is a need for competent instructors at the school, well filled by such men as Tech. Sgts. Foster, K7BAQ; Cesar, 8IMB; Ortiz, 5HPP; Staff Sgt. Wentz, 2OEK; Sgts. McKnight, 5JIS; Rovick, 8PST; McDevitt, 8JCU; Agresti, 8UQT; Lydiard, 1MCX; and Cpl. Meade, 9LQJ. Some of the students come from other parts of the country to take temporary training in advanced communications, and include: Staff Sgts. Browne, 9UII; Elm, 6ROO; Chriss, 9ZDR; Valys, 5KBQ; Turberville, 4GNZ; Chotkowski, 1KZV; Hajduk, 8HIS; Pvt. Liblick, 6FWU; Dunbier, 9ESQ; Martin, 5JTP; Longerich, 2GQY; Ginocchio, 2BDZ; Shelleday, 6CFT; Borges, 4DUA; Forrest, 3JLF; Linebaugh, 3HBT.

Staff Sgt. Knight, 1MMS, and Pvts. Lewis, 4CSZ, and Miller, 5IAR, are assigned to signal work at West Palm Beach, Fla. (Morrison Field).

Pvt. Castiglione, 2IMQ, maintains equipment of the 15th Sig. Platoon at the Bangor, Me., air base. Lt. Calkins, 7ILJ, commands the 23rd Sig. Platoon at Paine Field, Wash. There also in the 34th Air Base Gp. is Pvt. Vensel, 5BOR. Pfc. Erdmann, 2MZN, operates with the 4th Sig. Svc. Co., Ft. Dix, N. J. In the 106th Obs. Sqdn., Birmingham, Ala., are Sgt. Norris, 4HDU; Tech. Sgt. Smith, 4HQT; and Pfc. McLean, 4HPS. Pvt. Bent, 1JPK, operates with the 57th Sig. Bn., Camp Edwards, Mass. Major Doucette, 2JFG, has been called to active duty in the office of the Chief of Staff, Washington. Correction for September issue: M. Sgt. Smith is chief op. of the 6th Sig. Co.; Staff Sgts. Boyer, 9EFF, and Ernst, 9OVV, are asst. chiefs.

Cadet Smith, 1IZL, sends us this list of aviation cadets at Scott Field, Ill., training to become squadron communications officers in the Air Corps: Davis, 9KIC; Field, 4ACO; Korz, 9JWX; Maer, 5IA; Miller, 9KDM; Mitchell, SRAE; Pile, 7FDY; Scott, 2FGO; Futz, 9QDL; Tutwiler, 3JFW; Smith, 1IZL; Serrill, 5CHM; Ellis, 4DZY; Smith, 5FKW; Caplan, 2FPP; Van Houton, 2JJU; Ferrucci, K6MAW-K6PPR; Sandburg, 8KQG.

From Staff Sgt. Oppenheimer, 2IZT, we learn of the following amateurs who are students in the coast artillery radio school at Ft. Monroe, Va.: M. Sgts. Hornak, 1KNY; Magee, 2CAJ; Staff Sgts. DiLeo, 3HUV; Oppenheimer, 2IZT; Senter, 5GUZ; Yeates, 5GNT; 7ASG; Pvts. Smith, K6ERQ; Kramer, ex-3EDB; Timmons, 9FMO; Christian, 1NEE; Staff Sgt. Kaufman, 1NCD; Tech. Sgt. Chichester, 2LFA; M. Sgt. Underwood, 4EZL; Staff Sgts. Bitting, 6IYI; Watts, 7GGS; Hays, 7HNS; Covington, 5FYS; Ruebush, 5JUE; Manitsas, 1IJL.

Here is a list of amateurs attached to the local defense force sound and radio school at the Boston Navy Yard, supplied by Ensign Atchley, 1HKK, officer in charge: CRMs Giddis, 1ABG, and Callum, 1IAE, instructors; RM3c Ellison, 1GHB; Vecchione, 1ERG; Swensen, 1JVI; Mousaw, 1ERS; Parker, 1CUY; Potter, 1DTB; Tomaselli, 1MOA; Corbin, 8VHQ; Sic Gagnon, 1LQQ; Schreiber, 1KNX; Miron, 1ARQ; Farley, 1MCK; CRM McLaughlin, 1IRG.

Commanding officer of the Naval Reserve radio school at Charleston, S. C., is Ensign Lyman, 4FMZ. Among the CPO instructors are Lambertson, 4BV; Derby, 4JB; Timmons, 9GOS; Arbogast, K6EO; Allen, 4GBW. Students, nearly all former V-3's, include Kocsis, 2GWI; Honeywell, 4CZI; Howell, 4DEC; Pattillo, 4FER; Bond, 4FWM; Clarke, 4FXP; Kiser, 4FYP; James, 4HAG; Sills, 4HDO; Murry, 4HPZ; Lucas, 4HQL; Sebastian, 4HUM; Post, 4HWU; Rogers, 4OG; Chaffin, 5BMU; Crouse, 5GCR; Davis, 5HIY; Nichols, 5HUQ; Hardison, 5JLN; Zreet, 5KBS; Searl, 8VNA.

Additions to the current officer's communication class at Noroton, Conn., are Ensigns Atkinson, 5GOC; Morrison, 9EMC; Haeger, 4BYK; and Foster, 9TOO. New members of the refresher courses are RM1c Devine, 1MPZ; RM2c Greene, 8PWU; Michelson, 1IZT; Miller, 9ULR; RM3c Martin, 1KUV; Van Kirk, 2HVO; Willet, 1ESP.

Amateurs at the Pensacola, Fla., Naval Air Station have formed the "Gospport Club," among whose charter members are the following: Lt. Comdr. Taylor, 4PBW-4HQ, Communications Officer; Lts. (jg) Bush, 4FB; Parkin, 5GJR; Pickett, 9UUR; Hodge, 9CFL; Vrazey, 4ABY; Ens. Hawley, 4ZU; Powers, 4QU; Green, 5BKH.

(Continued on page 32)

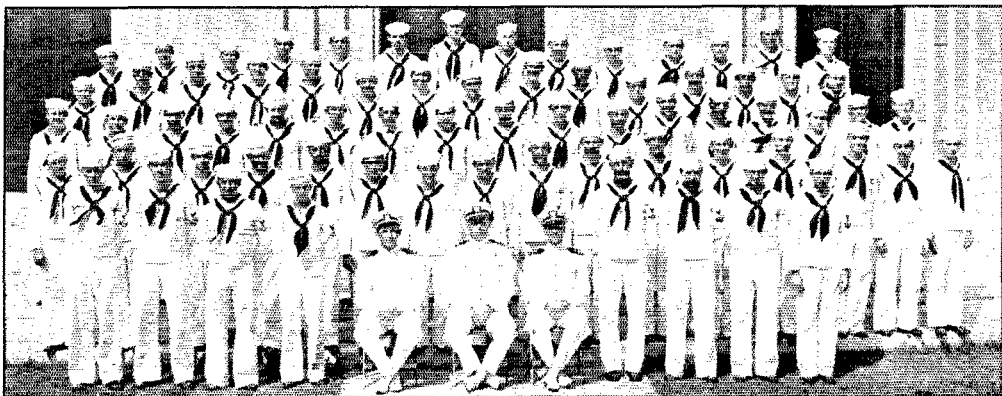

Radio classes graduating in September from the U. S. Naval Training School at Indianapolis, Ind., included these 75 radio amateurs. In the group are: W2JEJ, KSI, W3DLZ, GWW, JMK, W4CNE, EKG, HIQ, HPP, W5BDR, CWV, HQD, ICB, ISS, JZE, RW, W6EMI, QIE, SJM, TDM, UBV, W8IKV, NHO, NUS, ORD, OTA, OTN, OCK, QJK, RF, RKU, SEY, TDF, UHS, VET, VP, WJW, W9AKH, AOS, APJ, DMI, EVA, FWW, FXY, IMP, IQP, KFH, KME, KXU, LIG, NRC, OOD, QVK, RAG, TKF, TYM, UFR, VAG, VKP, VVP, YAC, ZWV, ZZU. Officers of the school (seated) are: Lt. (jg) A. W. Sieck, W9IND; Lt. Comdr. Boyd Phelps, W9BP; Lt. Elmer H. Schubert, W8ALW.

A Mobile Transmitter for 2½ Meters

Simple, Low Cost and Convenient Mobile Operation

BY VERNON CHAMBERS,* WIJEQ

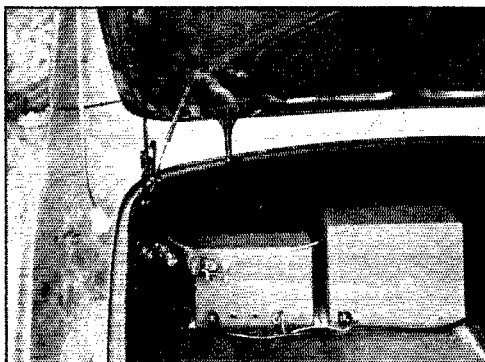

Installed in rear trunk. Note the antenna insulator and vertical antenna rising from it.

A MOBILE transmitter usually is classified as auxiliary or emergency equipment, and because it is an "extra" preferably should be relatively easy and inexpensive to construct. Furthermore, if it is built for regular mobile operation it shouldn't be one of those "on-the-seat" or "lashed-to-the-floor" affairs, particularly if you're in the habit of taking the YL or XYL out for a Sunday drive. (Haywire is one of the best ways of putting an end to mobile work we know of; you've just got to keep the outfit neat — or else!) And besides the greater operating convenience, a lot of personal satisfaction results from making the installation trim and shipshape.

The 112-Mc. transmitter to be described uses simple circuits and requires a minimum number of components. Construction is not at all difficult and the cost does not exceed twenty dollars including tubes, but not including the power supply. The transmitter is compact and will fit nicely in the trunk or baggage compartment at the rear of the car. A control box which mounts on the steering post or instrument panel gives convenient operation.

Circuit Details

The oscillator employs an HY-75 tube in the ultraudion circuit, using fairly high *C* to improve the carrier stability and reduce frequency modulation. Although a 3000-ohm grid-leak is suggested for the HY-75 in the data accompanying the tube, we found a 6000-ohm resistor better in

* Technical Information Service.

this particular application. The tube will draw a plate current of approximately 50 ma., without load, with the lower value of resistance, while the 6,000-ohm leak brought the no-load current down to 35 ma. As 50 ma. was the full-load current at which we intended to work, the higher grid-leak value left an extra 15 ma. for loading. Coupling between the oscillator tank circuit and the antenna is varied by means of a swinging link.

The audio end of the transmitter employs a single-button carbon microphone working into a 6C5 Class-A driver stage which is transformer-coupled to a 6Y7G Class-B modulator. With a 6-volt battery the microphone output is more than adequate for full power output from the speech system. The Class-B modulator was selected because of its higher power efficiency and lower average plate current than a Class-A modulator. As a result, the proportion of the limited power-supply output current which must be reserved for the audio section is relatively low. Actually, the idling current of the two audio tubes is only 25 ma., with instantaneous peaks running in the neighborhood of 100 ma. The average drain with modulation is approximately 50 ma. which leaves 50 ma. of a 100-ma. supply for the r.f. stage.

The 6Y7G, an octal-based version of the 79, requires a plate-to-plate load resistance of about 14,000 ohms. The oscillator, operating with 300 volts at 50 ma. represents a load impedance of 6000 ohms, so that the primary-to-secondary impedance ratio required in the coupling transformer

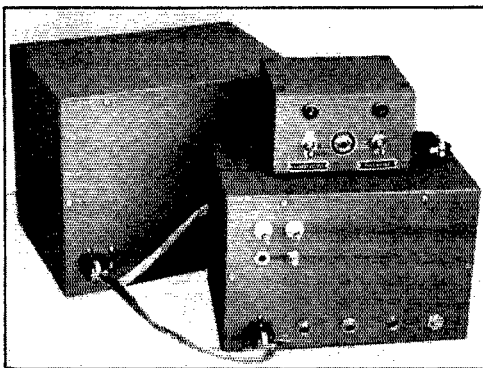

The complete transmitter before installation. The vibrator supply is in the plain box at the rear. The two larger units are installed in the trunk of the car, the control box in the driving compartment.

is 2.3 to 1. With the transformer specified a close approximation to this ratio is secured when the taps are selected to match 4500 ohms to 10,000.

Transmitter Construction

The transmitter is enclosed in a metal cabinet measuring 5 by 6 by 9 inches. Most of the parts are mounted on a chassis (ICA) measuring $4\frac{3}{4}$ by $8\frac{1}{2}$ by $1\frac{1}{2}$ inches. The panel and chassis are fastened together by the d.c. input plug, gain control and jacks which may be seen in the front-view photograph; the microphone jack, J_3 , is the one at the right. Feed-through insulators which serve as antenna terminals are shown at the top left-hand corner of the panel. A hole for screw-driver tuning of the oscillator is drilled below one of the antenna insulators. This hole should preferably be drilled after C_1 has been mounted to insure that it lines up with the condenser shaft. The swinging-link control shaft is to the right of the hole just mentioned.

The inside photograph of the transmitter shows the arrangement of the main components. The 6C5, T_2 , the 6Y7G and the HY-75 may be seen from left to right along the rear edge of the chassis. T_1 is located at the front left-hand corner with T_3 to the right. C_1 is mounted on a stand-off insulator which elevates the condenser mounting bracket $1\frac{1}{8}$ inches above the base. The nut which

In a circuit way, there isn't much to a 112-Mc. mobile transmitter. But it pays to give a little thought to utilizing the limited plate power available in such a way as to get the highest effective power output, and to making the installation unobtrusive and convenient to operate. Here are some ideas.

clamps the mounting bracket and condenser together should be loosened and the bracket rotated 180 degrees; this reduces the length of the leads associated with the tuned circuit. The condenser shaft should be slotted with a hack-saw to make provision for screw-driver adjustment.

The r.f. circuit components are mounted as shown in the photograph, the combined assembly being kept as compact as possible. The plate r.f. choke is to the left of the tube, and the grid choke, C_2 and R_1 are at the right. L_1 is soldered directly to the terminals of C_1 . Small-sized shield braid is used for the flexible lead between the HY-75 plate cap and the tuned circuit.

The swinging link is easily constructed. Its basis is a panel bearing assembly with the shaft extension cut down to a length of 1 inch. A piece of $\frac{1}{4}$ -inch polystyrene rod is fastened to the

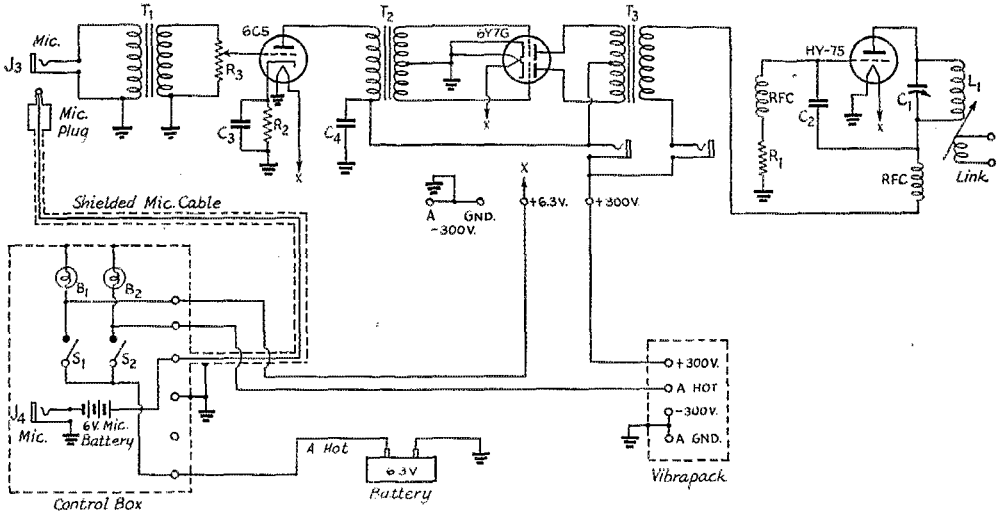

Fig. 1 — Wiring diagram of the 2½-meter mobile transmitter.

- C_1 — 35- μ fd. midget variable (Hammarlund HF-35).
- C_2 — 100- μ fd. mica.
- C_3 — 10- μ fd. electrolytic, 50-volt.
- C_4 — 8- μ fd. electrolytic, 450-volt.
- R_1 — 5000 ohms, 1 watt.
- R_2 — 1000 ohms, 1 watt.
- R_3 — 0.1-meg. variable.
- L_1 — 2 turns of $\frac{1}{8}$ -inch diam. copper tube, $\frac{3}{4}$ -inch diam., turns spaced $\frac{3}{8}$ inch.
- Link — 2 turns No. 12 wire, $\frac{3}{4}$ -inch diam., double spaced.

- J_1, J_2 — Midget closed-circuit jacks.
- J_3, J_4 — Midget open-circuit jacks.
- S_1, S_2 — Heavy-duty d.p.s.t. toggle switches.
- B_1, B_2 — 150-ma. dial lights.
- RFC — High-frequency r.f. chokes (Ohmite Z-1).
- T_1 — S.b. microphone to single or push-pull grids (Thordarson T-86A02).
- T_2 — Interstage audio, single plate to push-pull grids (Thordarson T-19D06).
- T_3 — Output transformer, 10,000-ohm primary to 4500-ohm secondary (Thordarson T-17M59).

metal shaft by means of a solid shaft coupling. The length of the insulating shaft is sufficient to bring the coupling link alongside L_1 . The ends of the link winding pass through holes drilled in the polystyrene rod; adequate rigidity will be obtained if the shaft holes are not made too large and if the wires are cemented in place. The panel bearing shaft is slotted to facilitate screw-driver adjustment.

The bottom-view photograph shows the arrangement of the parts mounted beneath the chassis. C_3 and R_2 are at the lower right-hand corner. C_4 is the condenser connected between the tube socket and the microphone jack. The shaft of R_1 should be slotted before the resistor is mounted. The 4-prong plug is mounted on the panel and projects through a $1\frac{3}{8}$ -inch hole in the chassis wall.

The cabinet has rolled-over edges to which the panel is fastened. The panel and chassis assembly cannot be slipped into the case unless the edges on the bottom and sides are cut out; the entire length of the side pieces need not be removed but the bottom edge should be cut off completely.

Control Box

The control box components are all housed in a metal utility box measuring 3 by 4 by 5 inches. The plug mounts at one end of the box and the rest of the parts mount on one of the long sides. The microphone battery can be placed inside the case, but this calls for filing down the turned-down edges since the opening is a little too small to pass an ordinary 6-volt dry battery.



A rear view of the transmitter chassis.

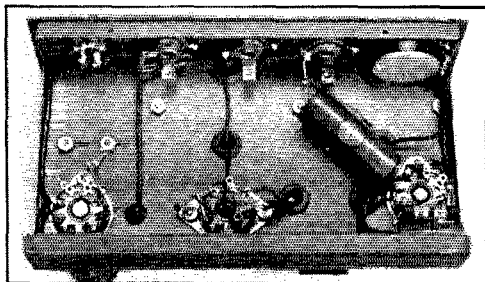

This bottom view of the mobile transmitter further illustrates the simplicity of the outfit.

Heavy-duty toggle switches should be used for the storage battery circuits. Most dealers carry a type designed for 125 volts at 12 amperes. These switches are nearly all of the d.p.s.t. variety and are the only compact toggle-type switches that will stand up in this application. The poles may be connected in parallel to increase the safety factor.

Power Supply

A 300-volt 100-ma. vibrator type supply is recommended for mobile operation. The self-rectifying type is the least expensive and places the smallest load on the car battery. Of course, any supply that will deliver the necessary voltage and current will be quite satisfactory. However, if the output voltage is over 300, it is recommended that it be dropped to 300 for the audio tubes. An a.c. supply for testing purposes may have the same output capabilities as the vibrator supply and should include a filament transformer designed to deliver 6.3 volts at 3 or 3.5 amperes.

Installation

It was possible to locate our control box in a clear spot because the car instrument panel was a shelf-like affair with a flat horizontal section near the windshield. Holes were drilled in the removable cover that serves as the bottom plate for the box and the unit was fastened to the shelf by self-tapping screws. This method takes care of the battery return leads for the pilot bulbs because the bulb sockets are connected to the box, which is in turn connected to the battery through the car frame. The cable to the control box has four wires. One runs from the "hot" side of the battery to S_1 and S_2 . The second and third (No. 14 insulated wire) connect the switches to the transmitter filaments and to the input side of the vibrator supply. The last connects to the microphone jack, J_4 , at one end

(Continued on page 84)

Texas Hurricane Finds Hams Ready

LEAVING a trail of wreckage 100 miles wide, with 10 dead and damage estimated as high as 25 million dollars, the Gulf of Mexico hurricane of September 23rd and 24th played havoc with the Texas coastal area.

The hurricane moved in from the Gulf and first struck the coast of Texas between Freeport and Port O'Connor, then progressed inland with hurricane violence. Strong northwest winds caused it to change its path and veer to the east where it struck Houston with tremendous force. Again it veered to the north and progressed with winds up to 40 and 45 m.p.h., eventually dissipating in northeast Texas. Wind velocities of 110 m.p.h. were recorded for gusts in the center of the storm area; Houston itself felt 90-mile winds in the center of the city. Tides of 8 to 10 feet were noted, and the water came within 6 inches of the top of the sea wall at Corpus Christi and Galveston. Great damage was done to crops, and virtually every coast city was partially flooded by the incoming seas.

The sweep of wind and water wiped out wire lines like a ruthless hand brushing aside a cobweb. Nearly every coastal city was without communications during the night of September 23rd.

There were no wires between George West and Corpus Christi. Palacios (in the center of the storm, where Camp Hulén is located) was without power or any kind of communication for twelve hours. There were no wires open between Corpus Christi and Galveston for most of the night. Finally, the unexpected turn of the storm that caused it to hit Houston destroyed all communications and power in that city for almost twelve hours. Even the following morning the only wires open to Houston were the private telegraph lines of the Humble Oil Co.

Texas hams met the need in traditionally competent fashion. Our report of the work comes from ARRL Acting Director Tom Caswell, W5BB, who was on the air continuously from the morning of September 23rd through September 24th at noon. As the communications officer of the Texas Defense Guard and NCS of the TGD/AARS net, Captain Caswell occupied a strategic post and served as relay station for practically all communications. Here is his report:

"W5LS, the well-known 'Salty' Johnson of Houston, and a member station of our network, left Houston early on the morning of the 23rd in an emergency radio truck containing a 300-watt c.w. transmitter, emergency generator, and good receiver. He headed for the point where it was estimated that the center of the storm would strike, for it was known several days in advance that it would be of hurricane violence and that communications would more than likely be dis-

rupted. He first set up at Bay City, Texas, and contacted me there at 11 a.m. At that time the barometer there read 29.00 and the wind was estimated at 30-40 m.p.h. Lieutenant Johnson then started for Port O'Connor, but was unable to get over the causeway at Port Lavaca due to high water and turned down to the coast at Palacios. There he found the telegraph office already having some trouble with communications, so he set up in the City Jail building to await the storm. He remained there until the next day at noon, and we were in constant communication.

"At the same time W5EY in Corpus Christi, with a 2-kw. a.c. generator was preparing to serve for Corpus Christi on 160-meter 'phone. W5BUZ and W5DEW in Port Arthur had emergency power also, and were ready to operate on both 75 and 160 meters. At 7 p.m. on the 23rd our TDG/AARS radio net was called to order. Through the net we had the following stations in strategic locations: W5IFW, Corpus Christi; W5HW, Houston; W5JYG, Houston; W5AHK, Wharton; W5EYV, Woodsboro; W5DIG, Galveston; W5LS/5, Palacios. All of these points felt severe results of the storm. Also, the other stations of the net were standing by for communication *out* of the emergency area to any point in the state. Our net frequency of 3920 kc. was cleared, and nearly all communications were carried on on this frequency. Later W5BUZ moved to it, as did W5FDR in Houston; these two stations were on c.w. as was W5LS and later W5AJ (who put much Houston traffic through via the telegraph lines of the Humble Oil Co. for us — he is a Humble employee). All other stations were on 'phone, including W5BB.

"W5IQN, Major Thomas of the Texas Defense Guard, and W5IKD of Austin helped me here in our all-night stand. W5IZN of Austin was monitoring 160 meters for any emergency traffic on that band, and W5JMJ of Austin, working on 40-meter c.w., was able to get a 40-meter c.w. contact between George West and Corpus Christi arranged for the Highway Department in George West that had had no communications with Corpus Christi for some time and that were very anxious to get information on the conditions of the roads through the area.

"W5OW, the AARS station of the 7th Signal Co. in Fort Sam Houston, was active nearly all night with outlets to the AARS nets, and W5DDJ in Beaumont, NCS for the South Texas c.w. AARS net, had his net standing by also. Although literally hundreds of stations were standing by on 3920 kc., I had almost no trouble in keeping the frequency clear. W4, W8, W9 and W7 reported in on the frequency and helped us keep it clear.

(Continued on page 94)



ON THE ULTRA HIGHS



CONDUCTED BY E. P. TILTON,* W1HDQ

FIVE didn't look too good in early September. Most operators on this band have fallen into the listening habit, and on the Ultra-Highs there are many times when just listening across the band doesn't present too encouraging a prospect. There are just about as many stations on Five, with gear ready to go, in the Fall as during any other season — but what to do to get them to go to work? First of all, we must get into the habit of putting our rigs on the air regularly. Call plenty of CQ's, and if you have a directional antenna turn it in all directions and make plenty of calls. If you hear a local on, give him a call. He is just as good a fellow to chat with as some guy 200 miles away, and you will be starting something, anyway. Make some definite skeds to work the stations at the edge of your reliable operating range, and try to get others in your locality to concentrate on operating these nights too. When the long-haul skeds are over, stay on the band and talk with the local gang. This gives fellows at distant points a chance to work on your signal. Let's keep activity on Five the year round — there's a lot more to this band than working skip DX — and when the band does open up there'll be just that many more stations to work!

*329 Central St., Springfield, Mass.

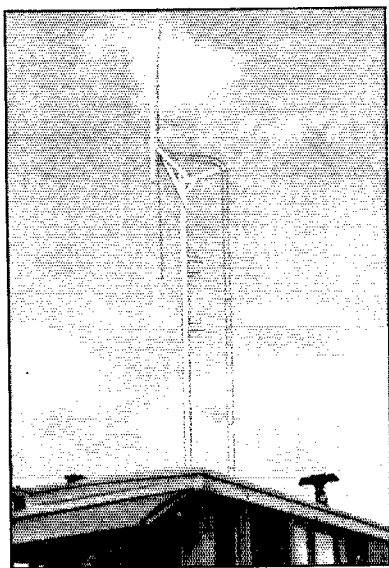

Mobile, at six miles per hour, with no ignition interference! The 112-Mc. extended double Zepp used by "Pullman-Car Charlie," W6TAT/6, can be lowered in two minutes for going through tunnels.

The chance to work that difficult distance which lies between the extremes of extended-local and sporadic-E skip coverage was afforded by the magnetic storm of September 18th and 19th. This was the most pronounced instance of this phenomenon since aurora DX was first noted in u.h.f. work, and reports indicate that it was the most widespread, geographically, as well. Aurora effect is present more often than most operators realize, but many times exists for only such brief periods that it is missed by most of the gang. But nearly everyone knew about this one, so brilliant and widespread was the display. It was, in fact, the first opportunity we've had to learn what would happen when the aurora was visible in all directions, and observers seem to agree that DX signals were strongest and the peculiar Doppler-effect distortion most pronounced near the beginning and end of the visible display — when the aurora was confined principally to the northern sky. During the peak of the show, the most beautiful in recent years, very little DX was reported; but in the early evening hours, even before sunset, and after midnight, signals were coming in (all from the north) from points within 600 miles in all localities above 36 degrees latitude in the East and Middle West. Less fading and somewhat less distortion of 'phone signals (probably due to the more constant nature of the storm) were noted than in previous sessions. Despite all our experience, and all that has been written about the necessity for c.w., and *c.w. only*, there were still many fellows in there trying to make voice contacts — but they were so much unintelligible hash to all beyond the purely local range. Here are a few reports:

W1LLL, Hartford, Conn.: Worked W8's RUE KKD OKC, W1NF. Heard W8's CIR QXV FGV, W3's AXU HDJ, W2's TP BYM AMJ.

W2DYM, Lakehurst, N. J.: Worked W8's KKD KWL NSS FGV KQC BPQ NYD OKC QXV. Heard W9's AQQ ZHB BDL GGH, W8's TDJ RKX KDR QXW CLS CIR, W4???, W1's NF KZU.

W2ILK, Staten Island, N. Y.: Worked W8KWL, W1NF. Heard W9AQQ, W8QQS, W8KKD.

W8FGV, Barberton, Ohio: Worked W9's ZHB IOD GGH AEH AKF HAQ RBK, W8's PK QQS QYD, W1KZU, W2BYM, W3AXU. Heard W9's AQQ QCY BDL WWH, W8's KWL TDJ, W4HEH, W1's LLL HDQ, W2TP.

W8TDJ, Morgantown, W. Va.: Worked W8's BPQ KKD, W9's BDL ZHB. Heard W1NF, W2BYM, W8's CIR CLS KQC KWL NSS NYD QQS RUE, W9's DDH GGH IOD QUV.

W8KKD, Royal Oak, Mich.: Worked W1's KZU LLL NF, W2BYM, W8's KWL PK TDJ RUE BFP, W9's ZHB AKF HUV WWH GGH ARN QUV CBJ ZHL. Heard W8OKC, W9YKX.

W9YKX, Woodbine, Iowa: Worked W8NSS, W9's GGH LLM QUV DWU FFV BDL AEH IOD. Heard W8's KKD QQP, W9's RBK HAQ ARN ZHL.

Nearly all of these contacts were made *after midnight*, the band being very active until nearly 4 A.M.! From this it can be seen that there is no lack of stations on Five, even at such an unholy hour. Why, then, should we have any trouble in keeping activity alive during an ordinary evening? We won't have—if every fellow will but do his part, and not just sit back and “let George do it.”

HERE AND THERE:

PROSPECTS for the U.H.F. Relay scheduled for November 1st and 2nd are shaping up very well. Every effort is being made to insure reliable routes from the Atlantic Seaboard to the Middle West. At some point in this stretch there has nearly always been an open spot, resulting in long delays in getting cross-country traffic delivered. Several new possibilities are now opening up which may help to prevent a dead spot this time. W3HWN, Mechanicsburg, Pa., now has a 5-element vertical array and a 4-element horizontal, and has increased power to 800 watts. He is now working W8CIR at Aliquippa quite consistently. This is still a very tough hop, nearly 200 miles of mountainous country intervening, and is still somewhat dependent upon good conditions. An intermediate between these two points would be most helpful. W8KHG, in a fine location at Kane, Pa., is showing interest, and should be a big help in making this path sure-fire.

Your conductor is now running test skeds with W8PK, East Bloomfield, N. Y. This is a hop of about 260 miles, with elevations reaching 3500 feet at the midpoint, but preliminary tests indicate that we may be able to make it on a fair percentage of tries. At 8 P.M. each Tuesday and Friday, W1HDQ, 56004, calls W8PK, 563, on c.w. All operators who can hear either end (or both ends) of this circuit are invited to join in this effort to provide W1-W8 contacts on Five. Horizontal polarization (278-foot vee at W1HDQ, 3-element rotary at W8PK) is being used for these tests, for the present.

And the Atlantic Seaboard Five-Meter Net is coming along. W1MPK, Portland, Maine (frequency around 57.2) is beginning to work down to the Boston area, and new stations are appearing at the southern end of the system. Most recent addition is W3BSY, Manassas, Va., 30 miles southwest of Washington, who has been working up to the New York area, 230 miles, and to your conductor, 355 miles, recently. W3BZ, Danville, long a lone voice on Five in southern Virginia, now has a convert in W4HEH, Greensboro, N.C. The stretch from Boston to Washington can be covered with ease almost any night. How about the territory between W3BSY and W3BZ — volunteers?

Skip DX is rare in September but W5AJG, Dallas, Texas, got in a bit on the 2nd. Leroy contacted W8RUE, and W9's IOD, VZP, and AEH between 7:15 and 7:45 on this date.

W5FYF, Oklahoma City, has no time for amateur work at present, what with his electrical engineering course at the University of Oklahoma and a night-shift job at KOMA. Vance reports a brilliant aurora display on the night of the 18th, though no reports of its effects on u.h.f. signals have been received from any point in the South or West.

Heavy earth currents on the land lines at the Southern Pacific telegraph office were noted by W6OVK, Tucson, but again no reports of DX on Five from out that way. Jim is determined to develop more activity on the ultra-highs in Arizona. With the help of W6's PGO, SLO, QLZ, and others, Jim is mailing out “propaganda” to every active amateur in Arizona!

After a disappointing slump, f.m. is actually beginning to take hold in a number of places simultaneously, as the boys begin to find solutions for the receiver problem. The Grammer F.M. Adapter (see March *QST*) seems to be the best bet for those who do not wish to undertake the construction of a complete f.m. receiver. Units of this type are now being used by W8TDJ, Morgantown, W. Va., and in Toledo, by W8QUO, W8ARF, and W8HSW. All these fellows are now using f.m. for transmitting also, as is W8JLQ, Howard

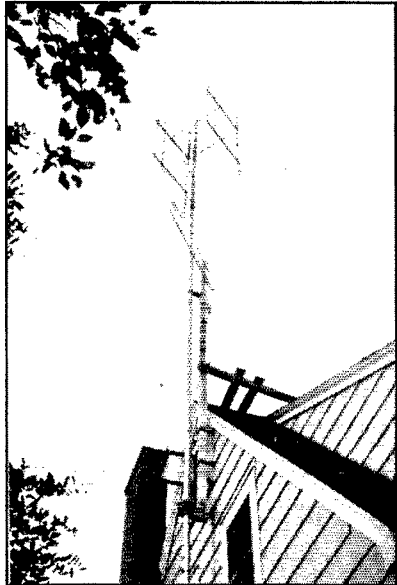

12-element 112-Mc. array at W2GPO, Huntington, L. I.

has a complete f.m.-a.m. superhet, and is reactance-modulating his 40-meter e.c.o. He says: “The swell part of it is the simplicity of the transmitter, and the rock-solid stability of all plate meters. It surely is a pleasure to throw away the distorting high-power modulator.”

W1EYM, Fairfield, Conn., is doing fine work with narrow-band f.m. Nat has been lending one of his f.m. receivers to various operators in order to develop interest in this method of operation. W1ELP, Cambridge, Mass., gets all the way down to Five from a 456-kc. crystal borrowed from an HRO — and his narrow-band f.m. sounds rather good, even on the most selective a.m. superhets, as does that of W1EYM.

The aurora session of September 18th and 19th provided W8KKD with W1 and W2 for his WACA. “Eighteen contacts, including five new states, out of twenty calls — and this morning's paper says that short-wave radio was disrupted!”

W9LLM, Downers Grove, Ill., reports W9TRA as a new Chicago station on Five, with W9FDA in Naperville about ready to come on. Frank has been hearing W9RBK, Newport, Ky., and W8QUO, Toledo, quite frequently. W9PK, Lyons, Ill., lost his 4-element array early in the month and finds Five rather flat without it.

Ever try to demonstrate the merits of the band to visitors and have it fall flat on you? W9ZHL was fortunate in being able to put on an impressive demonstration for the benefit of W9's DQU, LNR, GEI, BDL, ANE, and LVH, when this group staged an impromptu hamfest at his shack on the 14th. Contact was made with WOLF at Peoria, a distance of 150 miles, with S-9 signals each way. W8QUO, mobile, was a visitor in Terre Haute on the 11th and the boys had a fine time swapping ideas.

U.H.F. MARATHON

Call	Contacts Through September 15th				Score	States in 1941
	56	112	224	400		
W1AEP	107				1008	23
W1BCT		60			323	3
W1DJ	118	90			910	10
W1DLY	77				598	17
W1EET	63				453	6
W1EKT	113				834	16
W1HDQ*	233	119	4		2634	29
W1IJ	87	38			722	10
W1KIJ	196	112			2135	26
W1LFI	19	171			863	7
W1LMI	91	97			360	2
W1LSN					812	13
W1MBS		254			998	3
W1MEF/1	47	7			460	9
W2ADW	1	128			902	5
W2AMJ	181				1566	21
W2BYM	195	37			1802	27
W2COT	109	28			632	6
W2DZA		318	4		1202	6
W2FJQ	58	72			624	13
W2LAL	95	6			582	9
W2LKO		279			1127	5
W2MGU		174			706	3
W2MIV	48	192			752	9
W2MOF		111			443	2
W2OEN		122			594	4
W3ABS	59	1			226	5
W3ACC	96	22			694	15
W3AXC	29	6			136	6
W3AXU	128	20			917	20
W3BZJ		238			1260	5
W3CQV	88	6			683	16
W3FJ/3	45				386	14
W3GJU	63				296	10
W3HJD	81				680	16
W3HOH	99	300			1741	13
W4FBH	67	5			721	17
W4PKN	34	11			318	12
W5AJG	152				1673	25
W5DNN	40				458	13
W5PSC	40				416	16
W5JGV	48				854	19
W6ANN	62	215			1729	14
W6BPT	9				121	5
W6IOJ	16	34	1	2	313	1
W6OVK	77	8			1615	23
W6QC	49				678	10
W6QKM	4	86	1		347	1
W6QLZ	56	18			988	16
W6RVL	180				632	1
W6SLO	60				1282	17
W8CIR	115	10			1983	26
W8KKD	96	41			1188	16
W8KWL	17				205	10
W8MHM	3	25			197	1
W8QCS	58				652	16
W8RUE	54	12			350	11
W8TDJ	34	1			448	12
W8UUY	10				141	1
W9AB	25				194	7
W9ANH	39				350	11
W9ARN	83				1069	22
W9BDL	81				1190	21
W9EGQ	17				86	9
W9LLM	85	34	1		899	15
W9PK	103	1			995	25
W9PNV		109			623	2
W9YKX	82				1097	24
W9ZEL	67				887	17

Seventh Period Winner: W1KIJ, 461 points.
Eighth Period: W3HOH leads with 351 points.

* Not eligible for award.

Who will make WAS first on 56 Mc.? A few years ago anyone would have scoffed at the idea that such a feat would ever be possible, yet now several fellows are within striking distance and await only development of activity in a few states to make the grade. We believe that W9ZHB is nearest, and we understand that Ed got State No. 44 on the 18th by working W4HEH, Greensboro, North Carolina, during the aurora session. This leaves Ed with, we believe, only Nevada, Utah, Tennessee and South Carolina to go — a truly remarkable record!

112 MC. AND UP:

WHAT happened on 2½ during the big aurora show? Thus far we have heard of no DX observations, though it

seems that there may well have been some unusual happenings. It is interesting to note that we began to observe, and later on understand, the peculiarities of Five only after the development of better receivers than the familiar superregen gave us the ability to work with weak signals. We believe that similar receiver progress must be made on 2½ before the true value of the band will be known.

Experimentally-minded men now have rather generally turned away from the rush-box; for, unlike the early five-meter days, there are now several other receiving systems which are entirely practical and relatively simple to design and construct. Let's look over some of them.

A converter seems to be a logical start. For 2½ this used to mean three expensive and somewhat fragile acorns, but now we have the rugged and not too costly 9000-series miniatures, so the cost angle is just about solved. But into what should we work the converter for an I.F. channel? For receiving stabilized signals of good quality, the low-frequency communications receiver may be used, but there are relatively few stable signals in most sections of the country as yet. A good combination for use with the converter is a superregenerative detector, preferably with an r.f. stage, running on the same frequency as would be used in the communications receiver, with provision for switching the converter output from one to the other. If one has a commercial f.m. receiver this will provide splendid reception on 2½ if the converter output frequency is changed to approximately 43 Mc., or any other spot in the f.m. band where there is no strong local station.

Probably the best solution to the receiver problem at the moment is the f.m. superhet, which may, of course, be built in unit form, starting off with the converter and adding the f.m. and a.m. I.F. channels later as time and finances permit. This type of receiver may be designed to have a degree of sensitivity and selectivity far beyond that of the best superregen and yet still be broad enough to produce good quality on all but the worst of the oscillator rigs (and these would sound tough on any receiver!). Best of all, the f.m. job is not bothered by radiating receivers unless they are extremely strong or in the immediate vicinity, and then they only sound like the swish of a carrier being tuned across the band — not the annoying screech with which those of us who operate in congested areas are all too familiar! Our f.m. job, using a Browning 3-Mc. f.m. I.F. amplifier (with the interstage transformers peaked for maximum output, rather than a flat-topped curve) and an acorn converter unit (see January 1940 QST) is the first receiver we've had which has permitted us to hear anything but local transceiver QRM in recent busy nights on 2½. With it we have been surprised to find that we can hear W2's and W3's at distances beyond 100 miles quite consistently, often through heavy local QRM.

W1KIJ, Fall Mountain, Bristol, Conn., is now using f.m. on 2½. The users of superregen receivers tell him he's under-modulated, though quite readable, but on the f.m. supers at W1HDF, W1HDQ and others, Bob has the signal.

September 10th was a big night for W2KPB, Shelter Island, N. Y. Using the "Inexpensive 112-Mc. M.O.P.A." described by him in August QST, Bill contacted 24 stations in the period between 6:42 and 10 p.m. Most distant was W1MIF, Beverly Farms, Mass., 130 miles. Other long hops included W1EYR, Sharon; W1HM, Rockland; W1MOH, Waltham; all of Mass.; and several W2's in the New York area. Shelter Island is at the far end of Long Island, nearly 100 miles east of New York City.

U.H.F. RECORDS

Two-way Work

- 56 Mc.: W1EYM-W6DNS, July 22nd, 1938 — 2500 miles.
- 112 Mc.: W2MPY 1-W1JFF, August 21, 1941 — 335 miles.
- 224 Mc.: W6IOJ/6-W6LFN/6, August 18, 1940 — 135 miles.
- 400 Mc.: W6IOJ/6-W6MYJ/6, September 14, 1941 — 40 miles.

W3BJZ, Glenside, Pa., got up to W1HDQ on September 3rd, for the first Mass.-Penna. QSO on 2½, a distance of 200 miles. F.m. superhets were used at both stations (plug). Your conductor was also heard that night by W3CGV, Wilmington, Del., nearly 250 miles.

Probably the only amateur station regularly operated from a moving train is W6TAT/6, the famous "Pullman-Car Charlie," who is now on 2½ from a rail detector car on the Southern Pacific railroad. Charlie runs about 30 watts to an HY-75 and is on the move, at a rate of 6 to 8 miles per hour, constantly. W6TAT may also be heard, occasionally, from the home location in Oakland.

After a rather quiet summer, activity is picking up around Chicago, according to W9PNV. George reports the organization of a 112-Mc. net covering the area and including several mobile stations. Tests across Lake Michigan have been successful, with W9PNV working W9AVE at Michigan City. W9's RLA, LLM, and PNV have been heard by W8AKR, a distance of 110 miles.

(Continued on page 94)

U.H.F. Round-Up

Nov. 1st and 2nd—9th Quarterly U.H.F. Test is Opportunity to add to States and U.H.F. DX—Score Separately for 2½- and 5-Meter Listings

The Round-Up Period: November 1st (Saturday), 3 P.M. local standard time to November 2nd (Sunday), 7:59 P.M. local time.

The Contest Aim: To add to fun, activity and u.h.f. QSO records by rounding up all u.h.f. amateurs and u.h.f. equipment possible for contacts on any or all u.h.f. bands on the dates given!

Besides new states and u.h.f. DX the get-together assures renewed friendships, and more QSOs and results passed around for everybody.

Transcons: Short test messages addressed to stations beyond your immediate "horizon" will be in order as usual, with publicity to the *longest relay-message route* reported. There is a chance that your message or one that you handle will go the greatest distance. Start them early and keep 'em moving (entirely by u.h.f.'s of course).

Scoring Contacts: List different stations worked in the contest period. Show the *location* of the stations *over 100 miles distant* obtained as you work them. In a given band,¹ a fixed or portable station may be worked but *once* for contact credit regardless of location. If you used more than one u.h.f. band, make a separate list of stations, and submit *separate* claimed score as obtained on *each band*¹ used.

Credit yourself with *1 point* for every such different contact with stations under 100 miles, and *2 points* credit for stations at distances of 100 miles or over.

Message Credits: To the sum of points computed as above, add points for message copies submitted with your point summary.

For *originating* and sending a test message of approximately five to ten words, specifically

addressed or "to any amateur" in remote sections of the country and submitting copy *with handling data*² (but one such message per station will be credited) 10 points.

For *relaying* such messages away from the starting point toward destination and submitting full copies (1 for receiving by radio, 2 for relay onward) 3 points. Reply messages relayed, with copies submitted, also count as just explained, but for originating stations, but 1 point.

Multipliers³: Points may be multiplied in turn by multipliers³ designed to credit (a) ability to use c.w. or m.c.w., (b) ability to work from field locations under portable designation.

(a) Points made with your transmitter using c.w. or m.c.w. (both for contacts and message credits) may be multiplied by two before other multipliers are applied. (C.w. aids identification at distant points and this also credits demonstration of ability in its use.)

(b) Stations under portable indicator may multiply all points made while actually operating portable or portable mobile by *two*.

Send your report, with claimed score and the message copies (or copies of preambles, addresses, and handling data²) promptly. Do not use marathon forms in reporting results. After you get your test message off, the aim is to work as many as possible and push other tests communications on their way in a responsible manner. Be sure to make a *separate* list of station-worked-points and message credits for *each different u.h.f. band you used*.
— F. E. H.

¹ The band your transmitter is on is the band on which the contact is counted in your report. If your transmitter is on c.w. and the man contacted uses voice, you score your work for c.w. credit; he scores his as 'phone.

² The *handling data* are the call of the station from which message was received, call of station to which the message was sent by radio and the time and date of *acknowledgments of receipt* between stations. The call of the reporting amateur should be on each message for identification.

³ If a message is sent using c.w. or m.c.w. both contact and message credit may receive the multiplier (a). (A buzzer keyed before a mike is the simplest method for producing m.c.w.) If all operation is in a portable status and using c.w. or m.c.w., it is convenient to use multipliers *after* all the contact and message points have been added. If part of the work is in a portable status, or only part use is made of c.w., *only* those parts of the total score may be given the appropriate multiplier. If you transmit in different u.h.f. bands, the same station may be worked more than once to count in the contact score.

Strays

W3HTB is Melvin J. Keydash! — J. R. B.

"The Burlington (Iowa) telephone company reported no trouble last night. When electricity is not available, automatic *transformers* provide current so that the service is not hampered even for an instant," says the local newspaper!

— S. W. L.

Vibrator Power Supplies

What They Are And How They Work

BY BYRON GOODMAN,* WIJPE

DURING the past five or six years there has been an increasing interest in the amateur ranks in portable, mobile and emergency operation. The AEC, the ARRL Field Day, and the increased activity by u.h.f. mobile units have all contributed to an increasing consciousness of the peculiar problems and enjoyment connected with the construction and operation of compact, self-powered transmitters and receivers. It is not unreasonable to predict a future when 75% or more of the active amateurs in the country will have equipped themselves for self-powered operation of one kind or another, even if the gear is low-powered and necessarily limited in its range. It can consist of either the regular station equipment, capable of ready transportation or installation in a car, or it can be a separate unit used only in an emergency or on field trips. In any event, its design revolves around the power supply that is to be used.

A gasoline-powered generator is undoubtedly the ideal answer to the power problem, but its cost and size limits its use to deluxe installations that can hardly be considered to be within the reach of the average amateur. Many excellent designs have been built around dry battery power, but the input is necessarily limited to the flea-power class and the more power one draws the shorter will be the life of the battery. By far the most logical and common source of primary power is the 6-volt storage battery found in every automobile, and this boils down the power supply to either a motor-generator or a vibrator power supply. It is the purpose of this article to show how vibrators work and to mention a few factors influencing their operation.

Principles of Operation

The vibrator power supply was developed for automobile broadcast receivers as a substitute for the dry batteries used in the first automobile receivers. Since its introduction it has been improved and made so dependable that it finds universal use in automobile b.c. receivers and widespread use in mobile transmitter and receiver applications up to demands of from 60 to 80 watts at 400 volts. Its major usefulness for amateurs is in the power class around 30 to 40 watts at 300 to 325 volts, although vibrator supplies are made in many sizes down to one that will operate from flashlight cells and furnish 10 ma. at 90 volts.

In effect the vibrator is simply a fast magneti-

cally-operated reversing switch that gives an a.c. that can be stepped up through a transformer, rectified and filtered. Fig. 1-A shows the connections for a reversing switch that, if it could be thrown back and forth fast enough, would allow the d.c. input to be changed to a.c. and stepped up through the transformer. There was a forerunner of the vibrator that consisted of a reversing switch driven by a small electric motor, and the old synchronous rectifier of early c.w. days was a motor-driven reversing switch of this type used as a rectifier. However, the motor wastes more power and is heavier than the vibrator type of reversing switch, and hence the over-all efficiency and lightness of the vibrator can be made higher. By putting two primary windings on the transformer, as in Fig. 1-B, a s.p.d.t. switch can be used for reversing, and the simplicity of this connection has made its use standard practice in vibrator design.

There are two general classes of vibrator supplies, the self-rectifying (synchronous) and the tube rectifier. These two types are shown in Figs. 2-A and 2-B respectively. The self-rectifying type has a separate set of contacts that reverses the current flowing from the secondary in synchronism with the reversals of current in the primary, while the other type uses an ordinary full-wave tube rectifier to obtain unidirectional current flow in the output circuit. The tube must have good insulation between cathode and heater, and several types are available. Proper battery polarity is necessary when using the self-rectifying type of vibrator — with the tube rectifier it makes no difference which way the battery is connected. Most of the self-rectifying vibrator units are now built so that they can be reversed in the socket, thus doing away with any necessity for reversing the leads from the battery.

To reduce surges in the circuits and to cut down the arcing and consequent wear of the contact points, a condenser can be connected across the contacts in the primary circuit. However, since it takes a large capacity to be effective at this low voltage, the condenser *C* (Figs. 2-A and 2-B) is connected across the secondary where a smaller value can be used. The action is the same, since the capacity is reflected back through the transformer to the primary. The value of this condenser is of considerable importance in proper vibrator operation, and it will be taken up later in greater detail.

The actual vibrator is somewhat similar to a

* Assistant Technical Editor, *QST*.

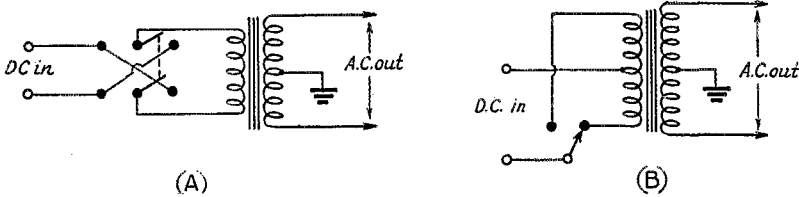

Fig. 1—The sketch at A shows how d.c. can be changed to a.c. and stepped up to a higher voltage by means of a reversing switch. The frequency of the a.c. is of course dependent on the number of reversals per second of the switch. The switching can be simplified by using a double primary winding as shown at B.
A vibrator is simply a magnetically-actuated switch of the type shown in B.

buzzer with some extra contacts on the armature, although the manufacturing tolerances are, of course, much closer and the contact material is vastly superior. The energizing coil for the armature, or "reed," can be connected in several different ways, but most of the present ones are connected in "series" (Fig. 3-A) or in "shunt" (Fig. 3-B). The connection of Fig. 3-C is the same as that of a buzzer, but it is impractical for high-efficiency use because it gives a pulsating d.c. similar to that obtained from a half-wave rectifier.

Vibrators have been built to operate at frequencies ranging from 85 to 165 cycles per second, but the present tendency is toward standardization around 115 cycles per second. Obviously the filter design will be dictated by the frequency and the load requirements, as in the case of other power supplies.

The Buffer Condenser

The condenser *C* of Figs. 2-A and 2-B is called the "buffer condenser" and its value is important to the proper operation of the vibrator. With no condenser connected across the secondary of the transformer, instantaneous voltage peaks caused by the kick-back voltage induced by the collapsing flux on "break" will occur at the start of each cycle that may cause insulation breakdown in either the transformer or the filter condenser. On the other hand, if the buffer condenser is of too high a value, it may cause excessive hum in the output and it will cause more rapid wear of the

vibrator points. Complete vibrator power supplies of reliable makes have the buffer condenser adjusted to the proper value and, if for any reason they have to be replaced, this value should be duplicated exactly.

A home-assembled vibrator power supply should have the buffer condenser adjusted properly when the unit is first built. This can be done by using an oscilloscope to watch the output waveform (a method outside the scope of this article but which is described in any vibrator service manual) or more simply through the use of a 0-10 ammeter in series with the battery line. The load is disconnected from the supply (this includes the rectifier tube in the case of a tube type or the filter in the case of a self-rectifying type) and the value of condenser is adjusted until the drain from the battery is a minimum. The proper value will usually be between 0.005 and

With the interest in portable and mobile operation running the highest in amateur radio's history, anything dealing with the power supplies for such units should bear reading by every active ham. This is not a how-to-build-it article, but it is a résumé of vibrator operation and adjustment that should clear up most of the questions you have had about vibrator power supplies.

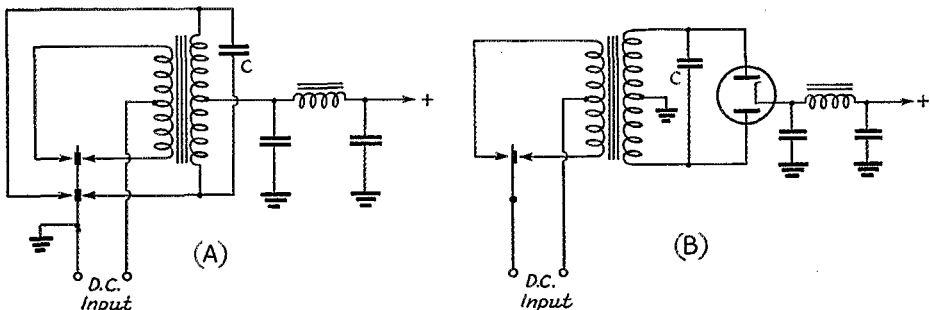

Fig. 2—The two basic types of vibrator power supplies are shown at A (self-rectifying) and B (tube rectified). The value of the condenser *C* plays an important part in the proper operation of any vibrator power supply, as explained in the text.

TABLE I—VIBRATOR POWER SUPPLIES

Manufacturer's Type No.		Output		Rectifier	Output Filter
Am. Television and Radio Co.	Mallory	Volts	Ma.		
VPM-F-7		90	10	Syn.	Yes
	VP-551 ¹	125-150- 175-200	100 max.	Syn.	None
	VP-540	250	60	Syn.	Yes
	VP-552 ²	225-250- 275-300	50-65- 80-100	Syn.	None
	VP-555	300	200	Tube	Yes
VPM-6 ³		250-275- 300-325	50-75- 100-125	Tube	Yes
	VP-557	400	150	Tube	Input condenser furnished

All inputs 6.3 volts d.c.

¹ VP-553 same with tube rectifier.

² VP-554 same with tube rectifier.

³ Also available without filter.

0.03 μ fd. If two values of condenser give the same minimum drain, it is safer to use the higher value of capacity. The buffer condenser should be one rated for at least 1600 volts d.c. working voltage, and oil-filled condensers are recommended by all vibrator manufacturers.

Hash Suppression

There is, of course, considerable r.f. "hash" caused by the vibrator because of the transients existing in the circuit and, if this is not eliminated, it can cause considerable interference in a receiver or on the carrier of a transmitter. The buffer condenser can be split up into two condensers of twice the value of the single unit with the center tap connected to ground, but this is not enough to remove all of the hash. Vibrator manufacturers say that the only way hash can be removed is by proper electrostatic and magnetic shielding, proper grounding and thorough r.f. fil-

tering of the leads to and from the vibrator pack. Commercial units are usually filtered and shielded to a satisfactory degree, and the home constructor may have to do considerable experimenting before all of the hash is removed from his supply. R.f. chokes are usually placed in the "hot" battery lead and in the positive output lead, along with an r.f. by-pass condenser on the pack side of each of these chokes. The battery-lead choke must be of a low resistance to avoid large voltage drops, and it is usually made of from 50 to 200 turns of No. 12 to 16 wire. The by-pass condensers range from 0.5 to 1.0 μ fd. Chokes and condensers will not eliminate hash caused by improper grounding and shielding, however.

General

A good vibrator unit will start with less than 5 volts applied to it, and any vibrator that re-

(Continued on page 96)

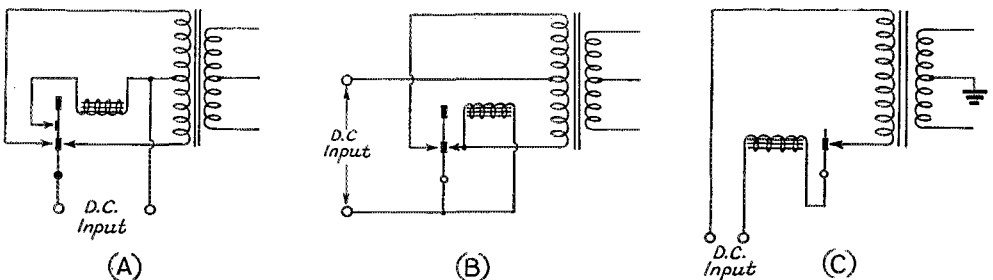

Fig. 3—Several possible ways of exciting the armature of the vibrator are shown here. The system at A is called "series-connected" and that at B is "shunt-connected." Some of the old types of vibrators were connected like a buzzer, as in C, but they operate at low efficiency and deliver an output similar to that from a half-wave rectifier.

It's Here—The 12th ARRL Sweepstakes

Nov. 8th-9th, 15th-16th—Awards to Section¹ Leaders—C.W. and 'Phone Certificate in Each Club—Gavel to Winning Club—Use Any Ham Band(s) and 'Phone or C.W.

BY F. E. HANDY,* WIBDI

THE "SS" has a universal appeal to amateur operators year after year. Many hams "WAS" after each year's "SS". This is the best chance of the year to progress toward that objective. Then too the "SS" requires cryptic exchanges of data just as meaningful as though being used to direct fire fighters or rescue squads in well ordered local civilian defense planning. The "SS" thus becomes helpful training in operator-station amateur defense abilities!

One's aim in the contest is to work as many stations as efficiently as possible. The points from such work will be multiplied by the number of different ARRL Sections worked with at least a complete one-way exchange in the contest. All essential contest information is sent in the form

* Communications Manager, ARRL.

¹ Including Porto Rico, Hawaii, Alaska, P. I.

² Free to ARRL Members on request. Likewise sent to non-members on receipt of 10¢.

³ See list of Sections in the ARRL field organization, page 4, of this issue of *QST*. . . Note that in view of FCC Order No. 72 that no contacts with Cuba count, and only the P. I. stations operated by U. S. citizens whose calls are given on page 44 of June 1941 *QST*.

⁴ There is no point in working the same station more than once in the contest period if two points have been earned by an exchange. If but one point is made the first time, you can add a point by working this station again for exchange in the opposite direction. Underline all such exchange entries in your "list," identify them by showing parenthetically the call of the correspondent station. Leave right or left report columns blank so that other pairs of exchanges completed in one contact are side by side.

⁵ Send the letters CK and just the three number RST report. In 'phone exchanges only two numerals need be used. Make a habit in all 'phone reports of saying, READABILITY . . . STRENGTH. . . This avoids confusing abbreviations. It is best radiotelephone practice *always* to avoid use of abbreviations. Instead of just the state (which is the same as the Section in many cases), identify your ARRL Section as, for example, Salem, Eastern Mass.; Providence, R. I.; Buffalo, W. N. Y.; Omaha, Neb.; Oakland, E. Bay, Hewlett, N. Y. C.-L. I.

⁶ All hams are requested to submit lists, even if they only show a small score on a postal. By doing this they help support claims made in logs from other stations and receive credit in *QST*.

⁷ The highest individually-attained score of any one of the operators of amateur stations having more than one operator is the official score for such a station. The summary of score must show *all* stations worked by *all* operators however, circling the entries of stations and/or Sections that cannot count in the official total. Awards will be based on the official total and will be made to the individual operator accredited with this total. To show the possible scores that can be built up by several operators at one station, such scores (all Sections listed by all points listed) may be shown parenthetically after the "official" score that counts toward a possible award.

of a standard preamble. Exchanges are for the record sent to Hq.

Many hams in the "SS" may add to their knowledge of the way preambles to ARRL messages are sent and acknowledged, and fills requested, accuracy of 'phone communication assured, etc. Take part and follow the standard practices set forth for these things in Operating An Amateur Radio Station.² Good operating practices avoid delay, prevent garbles, and overcome inability to write or take standard message forms. The "SS" builds operating keenness. The order of work follows the order of message preambles, and is the same used in handling of morale-building Trainee Traffic. New station records are invariably made in each "SS". It's operating fun and a builder of operator confidence and ability. "SS" telegraphing operators contact and compete with other telegraphing operators. 'Phone hams compete with other 'phone hams. Paper work is completed as you go along with nothing to do but total and summarize points and send it in. *Mimeographed contest forms will be sent gratis to anyone who sends a radiogram or drops a card for the same.* Use of our sheets is not required nor is advance entry necessary. The purpose is to help participants keep a uniform log. Follow the arrangement or form shown with this announcement. Draw your own columns on your own paper if you like . . . or ask us for a form.

The contest provides for 40 hours' total operating in the two contest periods. You can operate "solid" for one 33-hr. week-end (with 7 to go) if you wish. Cross-examination of logs makes it possible to check operating time. Every FCC-licensed amateur in any field-organization Section³ is urged and invited to take part. The general c.w. call is CQ SS CQ SS CQ SS de

THE CONTEST PERIOD

Time	Starts	Ends
EST.	Nov. 8 & 15	Nov. 10 & 17
	6:00 P.M.	3:01 A.M.
CST.	Nov. 8 & 15	Nov. 10 & 17
	5:00 P.M.	2:01 A.M.
MST.	Nov. 8 & 15	Nov. 10 & 17
	4:00 P.M.	1:01 A.M.
PST.	Nov. 8 & 15	Nov. 10 & 17
	3:00 P.M.	12:01 A.M.

W... W... W... and sometimes a single snappy CQ SS has been known to net a row of successful exchanges. Use any choice of authorized amateur frequency bands.

Certificate Awards

As customary, the League is providing certificates for this year's SS Winners, the two in each Section to go to the c.w. and radiotelephone winners. Additional certificates will recognize competitive effort in clubs, where three or more club members submit properly identified logs connecting their work with a particular club. At least three must compete for it, and report, to rate either a club 'phone or a club c.w. "SS" certificate. The sum of all club member scores ('phone and c.w.) for which logs are submitted will count toward a club gavel award to the nations' leading club in the "SS." By Section awards operators compete under equal DX conditions and operating opportunity. Operating enjoyment is assured. Ask any amateur who was in the SS last year.

Exchanges-by-Radio to Prove QSO's

Before points or Sections can be claimed at least a one way complete six part exchange must be completed and acknowledged between two stations as "proof of QSO"³ (It is not essential that each station worked be taking part in the contest to make your points count. Any operator who needs information can be referred to this announcement. First,

HOW TO SCORE

All contacts, count:

One point for each QSO when "receipt" is completed for an exchange one way.

Two points for each QSO when the required information is exchanged both ways.

For final score: Multiply totaled points by the number of different ARRL Sections² worked, that is, the number in which at least one bona fide SS point or exchange has been made.

Multiply this by 1.25 if you used 100 watts or less transmitter input at all times.

ask the operator to take your preamble and come through with like information in preamble form.)

More Rules

1. Information in contest exchanges (of five or six parts) must be sent in the order indicated, that of the ARRL message preamble. Incomplete exchanges or wrong order of sending justifies disqualification.

2. Entries should be (a) in the low-power class, or (b) high-power class. Any work on high-power places all of one's score in the high-power class. Logs must show the power used for each QSO or for groups of QSOs.

STATION W..... SUMMARY OF EXCHANGES TWELFTH A.R.R.L. ALL-SECTION SWEEPSTAKES

Freq. Band (Mc.)	Time On or Off Air	SENT (1 point)				Time	Date (Nov.)	RECEIVED (1 point)				Time	Date (Nov.)	Number of Each Different New Section as Worked	Points
		NR	Stn.	CK-RST	Place			NR	Stn.	CK-RST	Place				
3.5	On 6:10 P.M.	1	W1AW	579	W. Hartford Conn.	6:15 P.M.	8	3	W1KQY	589	West Haven Conn.	6:18 P.M.	8	1	2
"	"	2	"	439	W. Hartford Conn.	6:25 P.M.	8	7	W1FMV	479	New Haven Conn.	6:30 P.M.	8	..	2
"	"	3	"	589	W. Hartford Conn.	6:40 P.M.	8	2	W3FQZ	389	Takoma Park Md.-Del.-D.C.	6:45 P.M.	8	2	2
7	"	4	"	499	W. Hartford Conn.	10:18 P.M.	9	3	W8DZC	569	Elmira N. Y.	10:24 P.M.	9	3	2
"	"	5	"	579	W. Hartford Conn.	1:25 A.M.	9	7	W9BRD	589	Chicago Ill.	12:15 A.M.	9	4	2
"	Off 3:00 A.M. 8 hours 50 mins. P.M.	6	"	549	W. Hartford Conn.	2:50 A.M.	10	15	W9VKF	479	Minneapolis S. Minn.	1:55 A.M.	10	5	2
14	On 1:00 P.M.							14	W5KC	339	Plaquemine La.	1:05 P.M.	16	6	1
7	"	7	"	589	W. Hartford Conn.	3:00 P.M.	16	17	W5CWW	459	El Paso So. Texas	12:20 P.M.	16	7	2
"	"	8	"	579	W. Hartford Conn.	4:06 P.M.	16	11	W1BIH	589	Torrington Conn.	2:55 P.M.	16	..	2
"	"	9	W1AW	349	W. Hartford Conn.	4:30 P.M.	16	16	W6ONQ	439	Oakland, Calif. East Bay	1:31 P.M.	16	8	2
"	Off 5:20 P.M.	10	"	479	W. Hartford Conn.	5:10 P.M.	16	9	W9YFV	579	Chicago Ill.	4:15 P.M.	16	..	2

4 h. 20 m.
13 h. 10 m.

3.5, 7 and 14 Mc. used.

8 sec. 22 pts.
85 watts Input Power

Number and name of operators having a share in above work.....

Claimed score: 22 points X 8 Sections = 176 X 1.25 (85 watts input) = 220.

I hereby state that in this contest I have not operated my transmitter outside any of the frequency bands specified on my station license, and also that the score and points set forth in the above summary are correct and true.

Signature.....

Address.....

My tube line-up.....

Number different stations worked.....

EXPLAINING CONTEST EXCHANGES

<i>Send Like Std. Msg. Preamble</i>	<i>NR</i>	<i>Call</i>	<i>CK</i>	<i>Place</i>	<i>Time</i>	<i>Date</i>
In the "SS" Exchanges	Number contest info. sent consecutively, 1, 2, 3, etc., a new nr. for each station worked	Send your own call	CK (Rst report ^b of station worked)	Your city and section ^{3, b}	Send time of transmitting this "NR"	Send date of QSO
Purpose.....	The QSO-nr tells how you are doing; aids Hq. checking	Identification	All stations exchange complete reports	The ARRL Section is vital contest data	Time and date must check in both logs and fall within the contest period to prove each point claimed	

3. Reports must show operating time for each period spent on the air in the "SS," and the total of such operating time.

4. Logs must be marked for "phone" or "C.W." entry, grouping all work by either method together as one score.

5. All work must fall in the contest period.

6. Award committee decisions shall be accepted as final.

7. Reports must be received at ARRL Hdq. from all stations except those in Alaska, Hawaii, and P. I. on or before noon, Dec. 19, 1941 to be considered for certificate awards. From outlying points, reports must similarly be received on or before Jan. 23, 1942.

Additional Club Member Awards

Certificate awards (besides the 'phone and telegraph Section awards) will be made through each club where *three or more* individual club members, or new hams invited and reported by such a club, in addition to sending a contest report *have their club secretary* write Hq. listing their individual calls and scores and the total of such scores. *Only the aggregate of scores confirmed by ARRL receipt of Contest Logs shall count for the club.* If there are both club 'phone and c.w. entries ARRL will provide two certificate awards for the club to give its leading members. The sum of the scores of all club participants ('phone and c.w.) confirmed by logs will be added by the secretary, *to count for the club!*

A genuine gavel with engraved sterling silver band is offered as an award to that club whose officers or activities' manager submits the greatest collective score from "SS"

(Continued on page 100)

ranging independent copying contests for amateurs in their areas.

The argument between high-note and low-note advocates is temporarily stabilized by a paper on "The Operation of a Nonsynchronous Rotary Gap" by Prof. A. S. Blatterman of Washington University, reprinted from the *Electrical World*. He shows that there is a critical gap speed for each value of capacitance, and that one can be misled by relying simply on the transformer voltage as an index to the power in each condenser charge, since a lower spark speed gives time for the condenser to charge to a higher potential — although for lower speeds a larger condenser is necessary for maximum h.f. current in the closed circuit.

The first of the vacuum-tube lawsuits that so long disfigured radio has occurred, Judge Mayer holding that the deForest audion is an infringement of the Fleming valve patent, for which rights are enjoyed in this country by the Marconi Wireless Telegraph Co. of America — although the latter has also infringed the deForest patents.

Although most good stations use transformers, 9KY has a reliable 75-mile range with a 3-inch spark coil, input 24 watts. It may be attributable to the fact his ground connection is a half-inch copper ribbon suspended in a bored well 140 feet deep. Amongst the stations described this month is that of Charles W. Weber, 3AF (still with us as W3CC). Most amateurs are also interested in copying the long-wave undamped foreign stations, and this issue of *QST* contains a half-dozen advertisements of large loose-couplers for that purpose. Good results can be had on an antenna only 75 or 80 feet high. But apparatus is expensive: the William G. Finch Company (he who is later to be of facsimile fame) offers a detector box carrying one vacuum tube and containing batteries and necessary controls but embracing no tuning equipment (simply the binding posts for connecting to the tuner) for \$35. However, it's going to be a great winter and plans are on foot to hold a convention of all members who can attend in New York some time during the Christmas holiday season — something that has never been attempted before.



NOVEMBER, 1916, rounds out the first year of *QST*. Under its stimulus amateur radio has shown terrific progress in the past year. In late September, Route A handled a message from Chicago to New York and the answer back to Chicago in fifteen minutes, which is better than Western Union time. Big plans are under way for late winter. "Calls Heard" show good DX — East Coast amateurs are hearing well into the 9th district. John M. Clayton reports hearing 56 different stations in the past year. W. T. Gravely, 3RO, Danville, Va., has accepted appointment as the district superintendent for Virginia and North Carolina. With the European situation tightening up, the Navy is interested in determining the results obtained in tests with amateurs and the various Naval Radio Districts are ar-

★ I. A. R. U. NEWS ★

Devoted to the interests and activities of the

INTERNATIONAL AMATEUR RADIO UNION

Headquarters Society: THE AMERICAN RADIO RELAY LEAGUE, West Hartford, Conn.

MEMBER SOCIETIES

American Radio Relay League
Asociația Amatorilor Romani de Unde
Scurte
Associazione Radiotecnica Italiana
Burma Amateur Radio Society
Canadian Section A.R.R.L.
Československí Amatéri Vysílací
Deutscher Amateur Sende-und-Empfangs
Dienst
Eesti Raadio Amatooride Ühing
Experimental Radio Society of Egypt
Experimenterende Danske Radioamatorer
Fédération des Emetteurs Belges
Irish Radio Transmitters Society
日本アマチュア無線聯盟 Japan

Lietuvos Trumpuju Bangu Radio Megeju
Draugija
Liga Colombiana de Radio Aficionados
Liga de Amadores Brasileiros de Radio
Emissao
Liga Mexicana de Radio Experimentadores
Magyar Rövidhullámú Amatőrök Országos
Egyesülete
Manchoukuo Amateur Radio League
Nederlandsche Vereeniging voor Interna-
tionaal Radioamateurisme
Nederlandsch-Indische Vereeniging Voor
Internationaal Radioamateurisme
Newfoundland Amateur Radio Association
New Zealand Association of Radio Trans-
mitters

Norsk Radio Relé Liga
Polski Związek Kurzkofalowcow
Radio Club Argentino
Radio Club de Cuba
Radio Club Venezolano
Radio Society of Great Britain
Rede dos Emissores Portugueses
Reseau des Emetteurs Français
Reseau Luxembourgeois des Ama-
teurs d'Ondes Courtes
South African Radio Relay League
Suomen Radioamatööriyhdistys
Sveriges Sändareamatörer
Union de Radioemissores Espanoles
Union Schweiz Kurzwellen Amateur
Wireless Institute of Australia

GREAT BRITAIN

It is a sterling example of determination that the *Radio Society of Great Britain* has set in its two years of work while the country has been at war. And that determination has brought results which would be gratifying even under peace-time conditions.



"Old Jack in R.A.F. Blue." John C. Clarricoats, G6CL, secretary of the R.S.G.B. and editor of the "T & R Bulletin," has been commissioned in the rank of Flying Officer in the R.A.F. Reserve, and spends part of his time serving as Air Training Corps instructor in radio. "Jack" is probably Reason No. 1 why the society is in its present secure position, maintaining amateur organization and essential activities while awaiting the return to normal operation.

R.S.G.B. membership is above 3000 and, with an average of 90 new members each month, is rapidly nearing the all-time high of 3600! The society's financial condition is better than ever. About 1500 members are on active military service — half of the entire membership. Nearly all the others are engaged in non-military phases of the war effort, and R.S.G.B. has supplied personnel for many special technical jobs. Over 50 amateurs are serving as Air Corps Training instructors.

The *T. & R. Bulletin* appears monthly in almost normal style, with the single exception of lack of descriptions of transmitter equipment, now replaced by technical courses and lists of amateurs on active service. Good technical material is hard to obtain, of course, for all developmental work is being done by government employees who cannot release papers on it. Their "Handbook" has undergone two reprintings to supply the increased demand.

R.S.G.B.'s Council has granted honorary affiliation to a newly-formed Czechoslovakian Radio Society in England. It is planned to solicit membership of free Polish amateurs, as well.

URUGUAY

WE BID welcome to the *Radio Club Uruguayo*, unanimously voted into membership as reported in Calendar No. 27. Officers of the society are: Carlos Sosa Dias, CX1CF, president; Luis Rodriguez Subios, CX1AK, vice-president; Juan C. Izabuirre, CX3AA, secretary; and Juan Jose Posadas, treasurer.

SOUTH AFRICA

DIVISION 6 takes just pride in reporting that it has cleared its last year's debt and is now

(Continued on page 98)



ARMY-AMATEUR RADIO SYSTEM ACTIVITIES



War Department, Office of the Chief Signal Officer, Washington, D. C.

UTILIZATION OF AMATEUR RADIO STATIONS FOR NATIONAL DEFENSE

MANY inquiries and proposals concerning the use of amateur stations for defense purposes have been received by the War Department from Army-Amateur members and other interested persons. The sincerity and initiative of these individuals are greatly appreciated by the Acting Chief Signal Officer. The matter of utilizing the services of amateurs, however, is still under study by the Defense Communications Board.

In general, amateurs or other persons cannot be used as operators, instructors, technicians, etc., in the military service unless they can be enlisted in the Army. An analysis of the Form 170 Questionnaires recently accomplished by approximately 41,000 licensed amateurs indicates that the majority are not eligible for active military service because of their age (average 30-31 years), marital status (60% are married), having dependents or because of their physical condition. Therefore, their services normally would not be available to the War Department.

Dr. Lawrence J. Dunn, W2CLA/WLMD, chief radio aide of the AARS, has been appointed an advisor to George W. Bailey, ARRL president and chairman of the Amateur Committee of the Defense Communications Board. He will assist in drafting plans for the civilian-defense functions of Army-Amateur members. It is probable that the services of many Army-Amateurs and other interested amateurs will be used in a civilian capacity, particularly if they are not available for military duty. Examples of such employment are in connection with the Office of Civilian Defense, Air Raid Alarm Service and as civilian radio operators at fixed War Department stations.

Security requirements and the need for additional frequencies may necessitate the curtailment of all amateur operations in the event of war, except possibly those stations deemed essential for military or civilian defense functions. However, it is expected that due consideration will be given to the needs of State Defense Councils or other civilian defense agencies for qualified amateurs to assist in furnishing emergency radio channels for civilian communication needs under war-time conditions.

AARS ADMINISTRATION WORK TO BE HANDLED BY RADIO AIDES

THE increasing pressure of military matters has necessarily limited the facilities available at Corps Area Signal Offices for AARS adminis-

tration and operation functions. It is probable that the time which Corps Area Signal Officers and their Liaison Officers can give to Army-Amateur affairs will be further reduced in view of the civilian nature of this activity. Therefore, it may be necessary for Corps Area Signal Officers to delegate to their civilian radio aides such additional AARS administration and operation duties as can be effectively handled by the latter. Likewise, it is probable that many of the duties of the Liaison Officer, AARS, will be turned over to the Chief Radio Aide and the various Corps Area Radio Aides as deemed expedient.

SUMMER QUIZ CONTEST RESULTS

A QUIZ CONTEST on Army procedure was held during July and August. This consisted of a series of ten questions on Army radiotelegraph and radiotelephone procedure which were included in the Monday night ZCVA messages from Army NCS, WLM-W3USA, Washington. Army-Amateurs sent their answers through their net control stations to their Corps Area Signal Officer for scoring. The Ninth Corps Area won this quiz with an 83-point score based on an average of 83.3% correct answers received and a 99.7% average participation. The activity percentage was based on the average drill attendance for the month ending August 15th. Detailed results follow:

Corps Area	^a Average Drill Attendance During Summer	^b Partici- pation in Contest	^c Correct Answers Submitted	Score (b × c)
Ninth CA.	342	99.7%	83.3%	83
Second CA.	142	57.0%	87.6%	50
Third CA.	40	52.5%	94.7%	49*
Puerto Rican Dept.	6	50.0%	90.4%	45
Sixth CA.	235	36.2%	84.0%	30
Seventh CA.	111	29.8%	96.3%	29
Eighth CA.	105	21.9%	77.3%	17
Fourth CA.	324	15.0%	100.0%	15
First CA.	98	14.2%	100.0%	14 †
Fifth CA.	45	2.2%	83.3%	2 ‡
Total.	1448	45.0%	86.5%	

* Reports received on only 9.

† Reports received on only 8.

‡ Reports received on only 2.

STATISTICS ON AMATEUR RADIO OPERATORS

ANALYSES are being made of the data that have been tabulated from the questionnaires recently filed by approximately 41,000 amateurs. About 21,500 amateurs have signified

(Continued on page 108)



HINTS AND KINKS FOR THE EXPERIMENTER

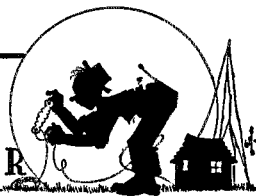

WORKING THE 80-METER ZEPP ON 160

W6NJE has had very good results on 160 with the antenna arrangement shown in Fig. 1. The antenna itself is an 80-meter Zepp with the feeders tied together. However, any wire which approximates a quarter-wavelength for 160 (length X) will work. The chief advantage is that a good ground connection is not essential to effective operation. The coil L is of a size to enable the

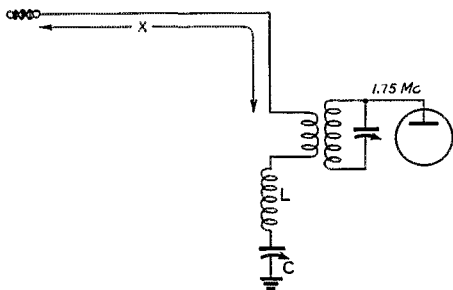

Fig. 1—Feeding 80-meter antenna, or any wire approximately one-quarter-wavelength long at 160. A good ground connection is not essential.

system to be tuned to resonance. W6NJE uses an ordinary 80-meter tank coil. The condenser C is small, approximately 50 μfd . It should have well-spaced plates. If desired, the system may be link coupled to the output tank circuit.

RESISTANCE-CAPACITY AUDIO OSCILLATOR FOR MONITORING KEYING

"Doc" Gilliam, W9SVH, calls our attention to the audio-oscillator circuit shown in Fig. 2, which he has found excellent for purposes of monitoring keying.

The circuit employs a "phase-shift" oscillator, described in the *Proceedings of the Institute of Radio Engineers* for February, 1941. The feature of the circuit, for this purpose, is that no inductances or transformers are required, although the quality of tone is very good.

R_2 controls the frequency over a range of about 200 to 1000 cycles, while R_5 in the grid of the amplifier circuit varies the strength of the output signal.

An important point in the arrangement is that the gain of the oscillator tube must be not less than 29. Values given in the diagram have been arrived at by experimental work of several months.

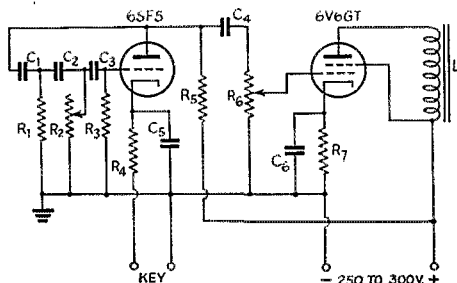

Fig. 2—Circuit diagram of the phase-shift audio oscillator for key monitoring.

- C_1, C_2, C_3 —500 μfd ., mica
- C_4 —0.01 μfd .
- C_5, C_6 —1 μfd .
- R_1, R_3, R_5 —0.25 megohm, $\frac{1}{2}$ -watt
- R_2, R_6 —0.5 megohm, variable
- R_4 —1000 ohms, $\frac{1}{2}$ -watt
- R_7 —250 ohms, 10-watt
- L —Output transformer or magnetic speaker

A MULTIBAND END-FED ANTENNA

WHEN multiband operation of an end-fed antenna is desired, the annoying problem of how properly to feed it always presents itself. It is often necessary, and sometimes desirable, to erect a transmitting antenna in such a way that an end is near the transmitter. Then one has the choice of either running a transmission-line out to the center of the system, or of using any of the conventional forms of end-feed with the attendant feeling that all will not be well when operating in a band other than that for which the antenna and feeder-system is designed.

One convenient solution to the problem of multiband operation of a Zepp antenna has been found. Take, for example, an antenna of natural period 160 meters, together with the usual feeder-system consisting of a $\frac{1}{4}$ -wave transmission line. This is a typical antenna-feeder system which we may wish to operate on 80, 40 and 20 meters, as well as the wavelength for which it is designed. To this system there can now be added another feeder, equally spaced from both the original feeder wire and the antenna, but of length $\frac{1}{4}$ -wave at 80 meters. Two more feeders can also be added of lengths $\frac{1}{4}$ -wave at 40 meters and $\frac{1}{4}$ -wave at 20 meters; all equally spaced with respect to the other feeder wires and to the antenna (see Fig. 3). This results in a 4-band Zepp system which performs equally well on any of the

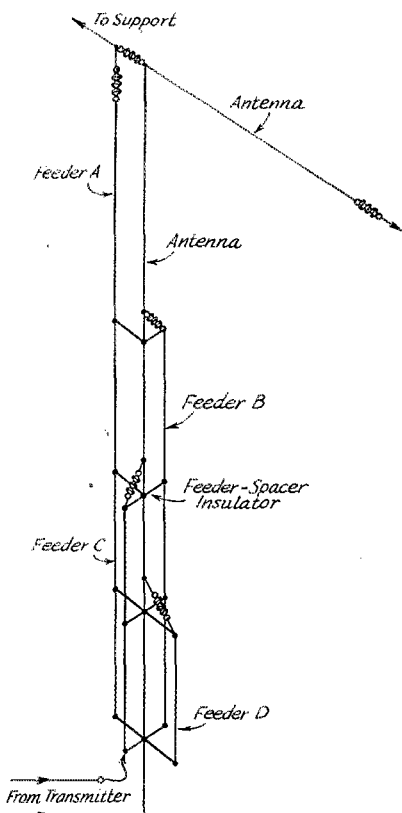

Fig. 3— Multiple feeders for maintaining feeder balance when using Zepp for multiband work.

four bands and which maintains a current-loop at or near the transmitter.

One may, with justification, ask about the length of the antenna itself, since it can not be of exactly the right length for all of the bands. Experiment has shown that any random length is satisfactory and that almost complete compensation may be made in the transmitter matching network. Somewhat better results are evident when the antenna-length is great (of the order of 300 feet or more) than when the length is small, although both long and short wires operate successfully. Two such systems were in operation for over two years, while perfect contact was maintained over a 12,000-mile path on two different bands. — *S. L. Seaton, VK6MO, Dept. of Terrestrial Magnetism, Carnegie Institution of Washington, D. C.*

CHEAP FILAMENT RHEOSTAT

AFTER searching for a small size rheostat to use in series with a 7½-volt filament winding for 6.3-volt tubes, I found that the rheostats ordinarily used on car heaters work very well. The

kind without indicating light sells for about 21 cents at most auto stores and it will dissipate the heat without trouble. It is small enough to mount in a number of ways, or may be mounted with a hole like other rheostats. — *W8TLW*

VARIABLE CRYSTAL FREQUENCY WITH AN 815 LOCKED OSCILLATOR

Fig. 4 shows the circuit of a locked-oscillator arrangement which has been giving a very good account of itself at WSKDG. The circuit consists of a conventional push-pull, tuned-plate tuned-grid oscillator circuit with the controlling crystal connected across the grid tank circuit. A type 815 is used, since its low-excitation requirements eliminate danger of high crystal currents.

With any good X-cut or low-drift crystal, the output frequency at 3.5 Mc. may be varied over a range of 7 to 10 kc. without losing the characteristics of crystal control.

In first adjusting the circuit, the plug-in coil, L_1 , is removed, the grid tank condenser set at minimum and the circuit tuned up as a straight crystal oscillator. The crystal is then removed and L_1 replaced. Then, without touching the tuning of the plate tank circuit, the grid tank is tuned to give output, as a self-excited oscillator, at approximately the same frequency. The crystal is then replaced and the signal monitored to deter-

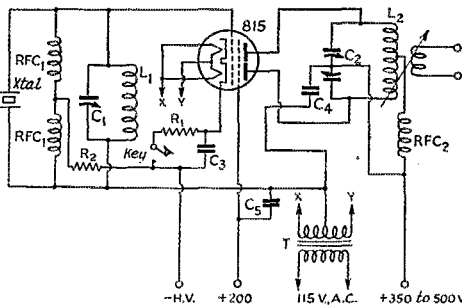

Fig. 4— Circuit diagram of the 815 as a locked oscillator.

- C_1 — 100 μ fd., variable
- C_2 — 100 μ fd. per section
- C_3, C_4, C_5 — 0.01 μ fd.
- R_1 — 250 ohms, 10-watt
- R_2 — 15,000 ohms, 1-watt
- RFC₁ — 2.5-mh. r.f. choke
- RFC₂ — 1-mh., 300-ma. r.f. choke
- L_1 — 56 turns, 1½-in. diam., 1¼-in. long (National AR80, no link)
- L_2 — 40 turns No. 20, 1¼-in. diam., 2¼-in. long (B & W JCL-80)
- T — 6.3-volt filament transformer

mine the range of tuning of the grid tank circuit over which crystal-control characteristics will be obtained. This is readily determined, because the note becomes rough as soon as the lock is broken. When one has become accustomed to the tuning

of the circuit, the separate steps will not be necessary and it will be simply a matter of plugging in the crystal and grid coil and tuning up.

The unit at W8KDG is built up in two decks with the grid components below and the plate-circuit elements above. This permits short leads and keeps the two circuits isolated, which is desirable for best results.

For greatest variation in frequency, the input should be limited to 25 watts. Inputs as high as 60 watts may be used without danger to the crystal, but the lock does not hold over so great a range of frequencies.

BOOSTING TRANSFORMER VOLTAGE

In the past few years, probably thousands of a certain make of transformer have been sold at a very reasonable price. I am sure you are familiar with the one I am referring to. The rating is 600 volts, 200 ma. and the transformer has $7\frac{1}{2}$ -, 5- and $2\frac{1}{2}$ -volt windings. The newer tubes such as the T20, 809, etc., need a bit higher voltage, so I have used a simple scheme to raise the

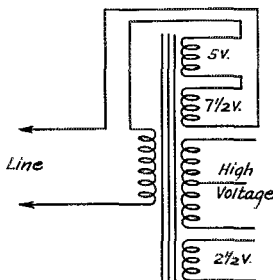

Fig. 5 — Making use of unused filament windings to boost plate voltage.

voltage. It means using separate filament transformers for the tubes but these are cheap or easily made. The idea is to connect the 5- and $7\frac{1}{2}$ -volt windings in series to give $12\frac{1}{2}$ volts which may be added to the primary voltage by connecting them in series with the line as shown in Fig. 5. The three windings must be polarized correctly to obtain this increase. Perhaps the easiest way to do this is to feed 5 volts or so from a separate transformer into the primary winding. This will enable the secondary voltage to be read on an ordinary 150-volt a.c. meter. Then try different combinations of the 5-volt, $7\frac{1}{2}$ -volt and primary windings until the highest secondary voltage is obtained. I am using my transformer in this manner with a pair of 866 Jr. tubes and with condenser-input filter get 700 volts at 200 ma. with no heating of the transformer. The increase in output voltage obtained by also using the $2\frac{1}{2}$ -volt winding is hardly worth while. — Noble Smith, W9HCO

IMPROVED VOLTAGE REGULATION FOR THE OSCILLATOR

In attempting to operate a self-excited oscillator and power amplifier from the same power supply, I encountered considerable difficulty with poor voltage regulation. A standard single-section choke-input filter system was used with an 83 rectifier and a transformer delivering 600 volts each side of center with a 200-ma. rating. The choke was a double 30-henry unit with

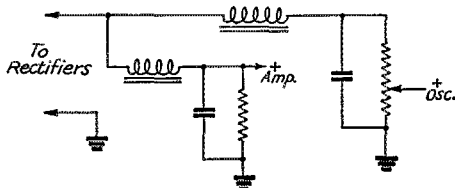

Fig. 6 — Improving voltage regulation at oscillator tap by use of separate filter choke.

the two sections connected in parallel. Each unit had a 125-ma. rating.

Investigation showed that most of the drop in voltage was occurring across the filter choke. Upon arranging the circuit as shown in Fig. 6, so that the amplifier current was drawn through a separate choke section, I found that the voltage at the oscillator voltage-divider tap remained practically constant when the amplifier was keyed. A 4- μ f. condenser in each branch provided sufficient smoothing. — John H. Stone, W8MYQ

Strays

W4HJQ is William Low Watt Webster!

— W4DVO.

If you tire of the pictures in the local penny arcade, a few minutes at the letter-punching machine will produce some good-looking labels for transmitter controls — at least it will if you can find one which hasn't run out of aluminum!

— W1KFN/2.

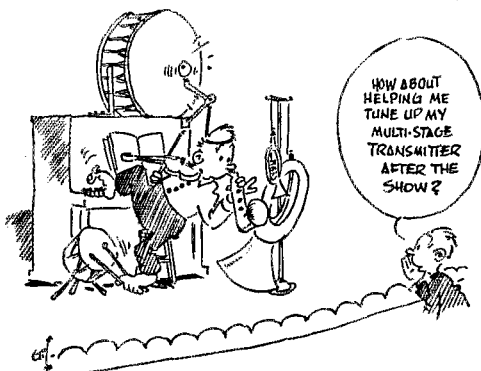



CORRESPONDENCE FROM MEMBERS

The Publishers of *QST* assume no responsibility for statements made herein by correspondents.

CP FROLIC

3815 Huntington Ave., St. Louis Park, Minn.

Editor, *QST*:

... It was unfortunate for all of us that the sun spots had to perform when they did, as the resulting aurora made our efforts look puny. ... However, I think that the tenacity of the boys in sticking to a bad cause is something of which we can be proud. By Sunday evening the bands sounded almost like old times, and I am sure that most of the gang was in there trying even while the effort seemed useless.

The contest was a great success, in my opinion. I was pleasantly surprised at the number of entrants and I was particularly struck with the high quality of the operating. I worked many stations whose calls had been issued very recently but whose owners' operating was as good as, though perhaps slower than, the work of the old-time contestants. There is no doubt that the giving of the certificates has raised the operating standards of us all.

And while I'm on the subject of operating ability, I want to put in another word for contests. There are some of the fraternity who are inclined to sneer at contests and laugh them off as something for kids. Well, I've been in the game since 1913, and I can say this for the SS, the ARRL Party, etc.: The operating is so good in those contests that it makes the ordinary QSO a rather slow and boring affair. Proof of this can be had merely by engaging in one of the contests, or even by listening.

When a station calls in a sloppy manner, with no break-in, with call too long, giving the impression of low operating standards, we in the contests don't have to wait to see whether he is calling "CQ CP" or "CQ SS" — we already know he is probably "not interested in contests." ...

—L. A. Morrow, W9VKF

Qtrs. 65-A, Ft. Belvoir, Va.

Editor, *QST*:

Having participated in SS, ARRL Party, ORS Party, ZCB Contest, etc., I consider the CP Frolic one of the very best of the lot. ...

Heard one guy calling "CQ NO CP." From the sound of his fist, he didn't need to advertise the fact.

—Bill Shuler, W3IWM

QRM ON WIAW

3920 Third Ave., Los Angeles, Calif.

Editor, *QST*:

A suggestion for stopping QRM on WIAW practice runs. If those fellows read *QST* they wouldn't be in there (if they were decent), so you can't touch them by squawking in *QST*. But when you are practicing and hear one, switch over to him and stay with him until you get his call. Then write him a nice little letter asking him to lay off and give a fellow a chance. While I was practicing I wrote three or four such letters. Now I have got my 35 wpm certificate and other things seem to claim my time, so I pass the idea to those still working. If you "holler every time you are hurt" it might do some good.

—I. D. Hough, Jr., W6SWD

428 S. Main St., Brookfield, Mo.

Editor, *QST*:

... The other evening on the 11:00 P.M. *QST* the QRM from a 'phone station got so bad that I had to give up and I switched off the b.f.o. to see if I could get his call. Here's what I heard:

... OK then old man I'll look for you on this same frequency tomorrow night. This is a swell frequency as there is absolutely no QRM except of course the *QST*."

"Except of course the *QST*!!"

I can stand a little accidental QRM from the newcomer but this intentional getting on WIAW's frequency simply because it has no other QRM burns me up. If I ever learn this W6's call he'd better watch out. It seems that he, and others like him, could give up this frequency for at least one half hour a night.

—Geo. P. Carpenter, Jr., W9MLV

SWING

4016 47th St., N. W., Washington, D. C.

Editor, *QST*:

Last night I had the pleasure of reading Part 1 of "The Secret of Good Sending" by E. L. Battey, W1UE. It is an excellent dissertation and written very understandably. All amateurs should read it, and it should be brought to the attention of student radio operators.

In no spirit of criticism, but merely in the interest of historical accuracy, I should like to take issue with Mr. Battey on a relatively unimportant statement which tends to perpetuate a growing misconception about "swing."

Mr. Battey, in emphasizing the importance of smooth, rhythmic sending, points out that "swing" is not desirable. He continues: "There is, for example, a certain swing called a 'sea-going' swing because it reminds one of the roll of a ship!" That is a cute explanation, but I do not think it is the real reason.

Dating back to the days of spark (not so very far back, where sea-going radio equipments are concerned) and of arc, operators had to work through interference and static. Static on the low frequencies, for those who may have forgotten, was kinda tough to work through — especially when the spark transmitter had a poorly adjusted gap and the signal sounded pretty much like static itself.

The thing called swing was evolved as the most effective means of copying through static. While the individual mannerisms of operators caused variations which led to highly individualized "fists" (the term "fist" could have originated directly in connection with this), the basic principle of what has been called "sea-going" swing is merely this: *Exaggerate the spacing between letters where a letter ending with a dash is followed by a letter beginning with a dash (such as W followed by O), and where a letter ending with a dot is followed by a letter beginning with a dot (such as F followed by R).* By many operators the exaggerated spacing was emphasized where the letter E appeared in a word. Exaggerated dash-length, where used, is largely a part of the individual's style, a possible exception being the first dash of the letter C, which is dragged slightly to assure a readable letter C.

An example might be made of the calling technique employed by WAX, the TRT station near Miami, and WPA, the RMCA station at Port Arthur, Texas, which are coastal stations serving the shipping in the Caribbean Sea-Gulf of Mexico area. The call letters WPA and WAX, if the operator aimed at perfectly uniform and swingless sending — and missed slightly — would be confused. The P might run into the A and sound something like WAX when WPA was intended. Too, if the other guy was tired or careless the A and X might run together and sound like a messed-up attempt to send the letters WPA. The problem, however, is solved beautifully: they swing it! WPA sends his call with

(Continued on page 102)



OPERATING NEWS



F. E. HANDY, W1BDI, Communications Mgr.

J. A. MOSKEY, W1JMY, Asst. to the Coms. Mgr.

Civilian Defense Nets . . . u.h.f. Progress. In September *QST* we called for more u.h.f. nets collaborating with local defense councils, and their police and fire-fighting groups of each municipality. In these pages this month we are glad to include one item already indicating the successful progress of the work of the Canton (Ohio) Amateur Radio Club right along these lines. It is estimated that 112-Mc. activity in the nation has trebled throughout the past three months. Progressive amateurs everywhere are making u.h.f. gear an adjunct to their other station equipment. Operating organization for civilian defense needs is proceeding rapidly — as fast as the u.h.f.-equipment-with-handles multiplies in skilled amateur hands in the various communities.

The Communications Department has asked 400 active affiliated amateur radio clubs (1) to promote u.h.f. networks suited to civilian defense, and (2) to recommend local u.h.f. leaders to receive SCM-appointments for carrying forward set constructional programs on a uniform pattern, for promotion of tests and activities, and contact with civilian defense committees, and the Local Defense Coördinator at the proper time. The League program is to develop and extend amateur-u.h.f. preparedness on a broad front without delay. Many Section Managers have already appointed group-recommended u.h.f. leaders, and these and all Emergency Coördinators of the ARRL will receive special bulletined civilian defense information on organization procedure as fast as this is developed and OCD advices permit.

It is suggested that every amateur station *not* u.h.f. equipped dig down in the junk box or otherwise acquire suitable operative stations. Individual stations should endeavor to keep four-point schedules, with similar stations north, south, east and west, the "grid" established connecting adjacent suburbs and towns. Network tests in which all members of the network communicate to a central point should be arranged by each ARRL Emergency Coördinator or other ARRL organizer (a PAM-UHF in some cases) as soon as practicable.

Are You Part of Organized Amateur Radio? ARRL provides appointments for those members who qualify for specific useful radio operating objectives. Net certificates give recognition through SCMs to Section Network operators. The AARS is similarly an organized

civilian amateur radio group which contributes to the positive values in our hobby. In these times each amateur should ask himself if he can honestly prove his operation in "the public interest, convenience and necessity," for the sum total of our contributions to the public welfare become our *raison d'être*. This is to suggest that every amateur participate fully in *organized* amateur radio — through ARRL membership, in the Code Proficiency Program (if you haven't our certificate award yet!), by applying for appointment in the ARRL field organization (all appointments are explained in the booklet *Operating an Amateur Radio Station*), by making your station one of those including u.h.f. readiness to serve the needs of civilian defense in which the networks are also expected to receive ARRL certification!

Wanted . . . 160-Meter C.W. Net Operators. All SCMs in the continental U.S.A. have been asked to report establishment of ten-point (or larger) 1.8-Mc. c.w. Section Networks at an early date. The SCM's choice of stations has been directed to cities in each Section where there are county seats, state police barracks, strategic highway or railroad centers, important electric, water or communications utilities, etc. No two of the net stations will be in the same city unless it is of unusual size. A group of the FIRST completed 10-station networks will receive spot-frequency crystals for their use.

Help your Section to get full coverage for its 1750-1900-kc. c.w. network by communicating with the Section Manager¹ concerning your readiness for assuming 5-day-a-week net operations. For this organized amateur work you will need also (1) to hold ORS appointment (arrange with the SCM); (2) to show at least a 25-watt station ready for e.c.o. or crystal controlled "160" operation; (3) to indicate readiness for an over-the-air test with NCS or SCM to prove the station signal adequate and indicate your necessary familiarity with ARRL standard network procedures. Is your city to be represented in this new Section network? Drop a line to your SCM¹ today and help this worthy project.

Fixed-Text ARL-CK Messages An Aid for Trainee and Holiday Traffic. Some years ago the League adopted a series of fixed-text "numbered" radiograms to use with certain precautions when necessary to speed up the handling of personal "agony" traffic in emergencies and for

¹ See full address of the SCM for your Section on page 4.

holiday uses. To expedite clearing of traffic during the 1941 holidays, and facilitate ready exchange of such radiograms between ARRL and AARS nets, the AARS announces its adoption of the ARRL Numbered Radiograms. The list of these numbered text messages appears on the back of the Number Sheet in each ARRL Log Book. Message list will be sent free of charge by ARRL on receipt of radioed or mail request. One additional new text² has been added to its list by ARRL at the request of the AARS.

The letters ARL appearing before the figures of the check or group count of a message indicate that the spelled-out number (or groups of numbers separated by "stop," "comma" or other punctuation) refers to the definition (s) given in the ARRL Numbered Radiogram list. Example of a fixed text message:

NR5 W1AW CK ARL3 Newington Conn. Nov. 5
Address BT THREE STOP TEN BT Bill AR

Nov. 1st-2nd u.h.f. Round-Up . . . Sweepstakes Week-ends, Nov. 8th-9th, 15th-16th. Don't pass up the top operating activities especially scheduled for November. Detailed announcement with the rules for scoring and taking part are given elsewhere in this issue.

Next Code Proficiency Program Qualifying Runs, Nov. 2nd (day), Oct. 27th and Nov. 23rd (evening). At this writing the reports of successful work in the Code Proficiency Frolic are still rolling in. It's too early to judge the high-point men's scores. The activity was widely acclaimed and definite plans are afoot for another Frolic. The September qualifying runs from W1AW showed a big upturn in applicants for Code Proficiency Certificate Awards. All U.S.A. amateur licensees who haven't such awards are invited to go after their certificates on the dates named. Get the certificate we want you to have. Be eligible and ready for the operating-test and station success offered in the next Frolic. Go after your ARRL code proficiency certification to-day. Information on the W1AW sending practice frequencies and qualifying runs appears on another page. Make regular use of the daily-except-Friday 9:45 p.m. EST W1AW practice.

— F. E. H.

² Add to log-book listing identifying "ARL" fixed-text Numbered Radiograms: SEVENTY ONE (71) Have not heard from you in some time. Please write at once or answer by amateur radio.

Hamfest Schedule

November 1st, at Malden, Mass.: The Suburban Net will hold a hamfest on Saturday, November 1st, at the Oak Grove Community House, Oak Grove Sq., Malden, Mass. Everyone welcome. A big time promised to all! Further information may be obtained by writing Douglas Corbett, W1KMR, 8 Willard Ave., Medford, Mass.

ARTICLE CONTEST

The article by Mr. Richard Nebel, W2DBQ wins the CD article contest prize this month. *We invite entries for this monthly contest.* Regarding subject matter, we suggest that you tell about what activity you find most interesting in amateur radio. Here you will find an almost limitless variety of subjects. Perhaps you would like to write on working for code proficiency, Emergency Corps planning, traffic work, working in Section Nets, 'Phone and Telegraph operating procedures, holding a League appointment, working on radio club committees, organizing or running a radio club, the most interesting band or type of ham activity, or some other subject near to your heart.

Each month we will print the most interesting and valuable article received. Please mark your contribution "for the CD contest." Prize winners may select a bound *Handbook*, *QST* Binder and League Emblem, six logs, eight pads radiogram blanks, DX Map and three pads, or any other combination of ARRL supplies of equivalent value. Try your luck!

Speed vs. Accuracy

BY R. E. NEBEL, W2DBQ *

THINKING over the title of this article should set up quite a trend of thoughts in the minds of those who consistently handle traffic. Does it bring to mind the number of deliveries in the past that have been returned by the postman inscribed "Unknown at address" or "No such address"? It makes one feel quite disillusioned to have this happen, especially if the message text appears to be of some importance.

How can we prevent such occurrences or at least take steps to prevent them? The usual reply to this query is, "Get rid of the speed-demons" so fondly referred to as "splatbugs" by that worthy southern gentleman, Dixie Jones. An even more explicit solution: Get rid of or educate those who attempt to copy the speed demons and whose false pride keeps them from asking for fills or the sending operator to decrease speed.

We all know that only a select few copy on "mills" which is the only method of making accurate copy at high speeds. When a sending station reaches speeds of 35 or 40 wpm it becomes difficult to turn out legible copy by hand. Here is where inaccuracy creeps in. Even though an operator is capable of receiving 50 wpm in his head, there is a limit as to how fast he can write. He is receiving every word perfectly and, according to his own belief, putting it all down. When he is finished, the sheet looks as if he had dipped a spider in ink and let it crawl over the page! "Oh, yes," he will tell you, he can read his own writing. But can he? Have you ever heard the other fellow (or yourself!) hesitate in the middle of a text while he apparently had to figure out what the next word was or, at the end of a message, tell you to change a certain word to one that appears more suitable (to him)? What a shameful practice! We know positively that many times all of you have wished the other fellow would slow down a bit so your copy, even though readable, would look a bit nicer. But do you ask him to slow down?

Therein lies the answer. Any operator, when asked to, will certainly slow down. By all means, don't feel that the rest of the net will look down upon you for making this request. Quite the contrary, they will look up to you when they realize that you consider accuracy of more importance than speed.

Why suppress or blame the speed demons? They have their place just as well as the slow pokes. If one of them sends to you at 45 wpm and you acknowledge each message without asking for fills or requesting that he slow

* 1104 Lincoln Place, Brooklyn, N. Y.

down, how is he to know that you are copying by hand and having difficulty? Speed is a great convenience and a pleasure to fast operators working together but has no place when one of the operators concerned must copy by hand.

There is also the matter of setting a precedent by accepting a message from one fellow at a great rate of speed. Naturally, even men who generally send at a moderate rate will, when sending to you, step it up as they are led to believe you want it that way. If they only knew that you preferred it slower!!

Make it a point to insist that the other operator slow down to your comfortable receiving speed and you will find that neatness in message handling holds greater pleasure for you than haphazard scribbling and going over and filling in texts from memory.

Minnesota Emergency Nets Reviewed by Red Cross and Defense Force Officials

AMID conditions not unlike those which might prevail during an emergency 35 stations of the Minnesota State Net reported in to their net control stations Sunday, September 14th, during a statewide demonstration drill. Working with both modes, c.w. and 'phone, member stations reported to their respective NCS with messages addressed to various of the eight agencies represented at a monitoring receiver operated for their benefit.

Seated around the monitoring receiver at the summer home of Carl R. Gray, Jr., chairman of the Transportation and Communications Committee of the St. Paul Chapter of The American Red Cross, representatives of The Minnesota Defense Force, The Civilian Welfare Defense Advisory Council, The Western Union, The Northwestern Bell Telephone Company, The Great Northern Railroad, The Northern Pacific Railroad and The St. Paul Police department heard the Minnesota State Net in action. The demonstration climaxed the organizational activities of the Minnesota Emergency Corp during the current summer, and provided the greatest recognition in responsible circles that amateur radio has ever received in the State of Minnesota.

Torrential rain accompanied by local thunderstorms prevailed across almost the entire state, but their influence was for the most part a beneficial one in that they provided an obstacle similar to what might confront the communications nets during an actual emergency. With two exceptions, the storms did not affect the operations enough to be classed as disastrous, W9YNQ at Spring Valley, Minnesota, suffered a complete loss of power and transmitting facilities when lightning struck his station just as he was transmitting his message. Having an emergency source of power was of little avail since a portion of the transmitter was damaged.

W9ICU at Thief River Falls also suffered some embarrassment when severe fading combined with the QRN and left him entertaining Major Schildtered and two Thief River Falls citizens with no signals audible for almost an hour. Conditions returned to normal, however, and the party approved the demonstration. W9FUZ at Bemidji had Captain H. S. Erickson and other officers as observers, and W9DOP at Crookston added to the good will by having Major Walter Betcher at the station. Likewise W9GKP invited Colonel Roger Weaver and throughout the state amateurs invited their local representative of the Minnesota Defense Force.

At the monitoring station set up for the express purpose of allowing ranking officials of The Red Cross and The Defense Force to witness the activities, great enthusiasm was displayed for the services amateurs can render. The receiving equipment and an explanation of the demonstration were in charge of W9ZWW who spent almost an hour and a half answering the questions of Mr. Gray and Col. F. G. Stutz, executive officer of the Minnesota Defense Force.

During the drill several stations from outside the state

answered the roll call and pledged the assistance of the organizations they represented in the event of emergencies requiring their services. Among these were W9LKL representing The Iowa Net, W9EKP, Nebraska Net, and W9QKL, Illinois AARS.

The attendance of 35 stations demonstrates the cooperative spirit on the part of an overwhelming majority of the net members. Much credit for the success of the drill goes to A. E. Swanberg, W9BHY, Minnesota Emergency Coördinator, whose organizing activities have built the MSN, both c.w. and 'phone sections, into a well integrated and smooth functioning organization.

Statistics on the MSN reveal that the c.w. section has been in operation since 1938 and has a present membership of 35 stations. It meets daily, and a goodly percentage of its members cannot remember the last time they missed a session. The NCS duties are rotated among W9NCS, QCP and MKI during the summer sessions, and stays with W9DNY throughout the winter. The daily volume of traffic moves with a smoothness that belies the amateur status of the group. The 'phone section was organized as a supplemental emergency channel as a result of experiences gained during the 1940 Armistice Day storm. The first session was held August 3rd, and the section now has 26 members. NCS is W9VVA, W9BHY alternate. Of the total net membership, 34 per cent have emergency power available, and the percentage of auxiliary emergency transmitters is almost that high.

Members of MSN participating in the drill were: C.w. section: W9CYX, BHY, DNY, EHO, FUZ, GLE, GKP, HMD, ICU, ITQ, JIE, MKI, NCS, ORT, QCP, WAS and YNQ. 'Phone section: W9AN, BHY, CUE, DEI, DOP, FEW, FUZ, HE0, HKF, HLC, HZV, IGZ, IXR, JIE, LSC, OOO, TLE, UWG, VVA, WAS, WKS, ZWG and LKL.

The results of this demonstration in public recognition and in improving relations with the agencies most benefitted by the amateur's emergency facilities have been extremely gratifying.

— J. L. Hill, W9ZWW

Radio Club Receives Generator From American Legion Post

EMERGENCY COÖRDINATOR W8MWL sends us the following: The Canton (Ohio) Amateur Radio Club has organized a u.h.f. net on 112 Mc. which, drills on Tuesday nights and has fourteen amateurs registered. These stations are collaborating closely with the Canton Ohio Fire Depart-



Members of the Canton Amateur Radio Club inspect the gas-powered generator presented to them by the American Legion. L. to R.: W8UZU, W8WNM, W8ADQ, W8WNU.

ment to provide necessary communications during time of disaster. The club's capabilities for defense were given special recognition on September 11th when it was presented with a 2-kw. Kato gas-electric generator by American Legion, Canton Post No. 44. On the occasion of the presentation ceremonies at the home of W8MWL radio messages were sent the national and Ohio commanders of the Legion, President Roosevelt, Mayor LaGuardia, civilian defense director, and Governor Bricker, using the new generator to supply all apparatus in the station with power.

Trainee Traffic Flash

The U.S.O. (NCCS) Program Is Expected to Add 100 Amateur Stations to Camp Facilities

AMATEUR radio clubs in which licensed amateurs in the services may control the radio equipment to be in the USO quarters are likely to swell trainee traffic to new highs before this season is completed. The National Catholic Community Service, an operating division of the USO proposes to install amateur communication equipment in each of the radio clubs that it will establish. About one hundred stations licensed to these clubs are contemplated.

This program is desired for the following purposes:

- A. To provide additional channels of radio communication throughout the continental limits of the United States that may, in time of emergency, be used to augment or replace the land lines, both telephone and telegraph, that might be seriously damaged or destroyed by flood, fire, tornado, earthquake, ice, riot, or insurrection.
- B. To place at the disposal of military commanders of all component parts of the armies and navies of the United States and representatives of the American Red Cross such amateur radio channels of communication as may be developed under this plan.
- C. To provide civilian amateur radio operators with a knowledge of Army and Navy methods of radio procedure and of the methods of using radio as a means of signal communication "in the field."
- D. To establish contact with a considerable number of civilian amateur radio operators for the purpose of acquainting them with the Signal Corps and Naval Communications Division, and American Radio League and their activities and securing their aid in experimental work, tests, etc.
- E. To render an opportunity to Service men to transmit messages to their homes and thus provide a strong support to the National morale effort.
- F. To render such encouragement and assistance as may be desirable to firmly establish and perpetuate the American amateur; and, to promote, generally, among civilians interest in the field of radio communication.

See page 64, October QST, for listing of trainee-traffic stations and frequencies. All amateurs are urged to participate in this amateur radio defense program by making traffic schedules with and for such stations.

Warning — Message Handlers and Ragchewers

THE code of operating precautions adopted for protection of amateur rights during the national emergency is still to be observed. Our medium of amateur radio is swift, instantaneous, and reaches beyond our countries boundaries so we must guard our speech, not talk about the war, ship sailings, troop movements or military contracts or other things of possible military significance.

All amateurs are warned by ARRL that they should examine with care every item of information that comes to their amateur radio stations. For example, no messages should be accepted whose addresses or texts identify the locations of ships or ship movements (as by giving a navy

Brass Pounders' League

Call	Orig.	Del.	Rel.	Extra Del. Credit	Total
W6ROZ	225	295	1800	286	2606
W7EBQ	226	436	1654	280	2596
W4DWB	11	50	1742	48	1851
W6FWJ	401	302	620	288	1611
W6GPB	266	364	444	353	1427
W2SC	70	106	1175	43	1394
W9JMG	61	76	1085	34	1256
W6LUJ	307	465	0	457	1229
K7HZM	0	0	1216	0	1216
W9DIR	45	158	744	145	1092
W9OZN	19	5	958	0	982
W5CNG	925	0	0	0	925
W3BWT	49	56	732	46	833
W8IFT/8	751	24	50	5	830
W9IHN	8	55	656	37	756
W9GFF	35	51	607	16	709
W5MNN	52	150	350	139	691
W3FJU	15	27	640	6	688
W8MCB	343	110	132	66	651
W8TZD	72	74	492	12	650
W9QKL	11	78	517	18	624
W8UFL	37	72	438	68	615
W8CJL	4	4	598	0	606
W9MIN	33	42	487	34	596
W6RGQ	43	61	377	61	542
W6RBQ	45	162	163	162	532
W9ILH	10	91	397	22	520
W2LZR	20	79	342	76	517
W4AOB	13	36	423	34	506
W9OUD	35	84	330	51	500

MORE-THAN-ONE-OPERATOR STATIONS

Call	Orig.	Del.	Rel.	Extra Del. Credit	Total
KA1HR	1858	1411	16	1308	4593
W3USA	137	50	1763	50	2000
W4QZ	81	53	1366	47	1547
W1AW	24	76	591	66	757
W9NFX	124	249	6	249	628
W8HDL	433	37	32	20	522

These stations "make" the B.P.L. with total of 500 or over. One hundred deliveries + Ex. Del. Credits also rate B.P.L. standing. The following one-operator stations make the B.P.L. on deliveries. Deliveries count.

W6DH, 232	W5CDU, 139	W9FUZ, 111
W8KWA, 222	W8QQK/9, 127	W9UN, 110
W5BSR, 207	W6CFN, 126	W8JIV, 105
W2DW, 154	W6ZC, 120	W2BGV, 103
W6LLW, 154	W6KOL, 115	W1HOR, 102
W2KLI, 152	W9YOS, 118	W9FJN, 102
W8PLA, 149	W3IWM, 112	W7HZG, 100
	W5BB, 111	

A.R.R.S.

Call	Orig.	Del.	Rel.	Extra Del. Credit	Total
WLMH(W6CDA)	20	15	841	10	886
WLN(W2SC)	40	98	449	47	634

MORE-THAN-ONE-OPERATOR STATIONS

Call	Orig.	Del.	Rel.	Extra Del. Credit	Total
WLM(W3USA)	278	169	2524	169	3140

A total of 500 or more or 100 deliveries + Ex. D. Cr. will put you in line for a place in the B.P.L.

man's address in care of his ship at the point docked). Persons on ships of the Navy may be addressed at a P. O. box, or even care specific ships, "Care Postmaster New York City," or "Care Postmaster, San Francisco," if desired. However, in view of naval re-routing of mail from these points, it is suggested that originators of messages to naval personnel (except those at Training Stations and other shore facilities) might as well receive their missives by U. S. mail in the first place, as nearly as fast. Rag chewing on the air about ship locations, troop movements etc. is taboo as just as much a potential violation of "security." All amateurs are urged to act as individual policemen to watch themselves and other amateurs and give the fraternity positive insurance against all indiscretions.

Trainee Traffic Stations

THE stations listed below are additions to the list published on page 64 of October QST. Other stations wishing listing are requested to send a postal card or radiogram addressed to the Communications Dept. with call, address, frequency, hours, names of operators and traffic outlets.

W1LYG — F. B. Banan, near Camp Edwards, Mass., originates from that point and will handle messages addressed to men at the camp.
 W1KGU/2 (1.75-Mc. 'phone) — Fort H. G. Wright, Fishers Island, N. Y.
 W2LXQ (1.75-Mc. 'phone, 3.5-, 7-, 14-Mc. c.w.) — Fort H. G. Wright, Fishers Island, N. Y., operated by V. C. Schmidt and Roy E. Watkins (W1MHH).
 W1MZF/1 — Don G. Hill, Westover Field, Chicopee Falls, Mass., has connections to W1AW via 112-Mc. link through W1HDQ.
 W8TKA/5 (1990, 3980, 14,176 kc.) — Pvt. George W. Bunce, U. S. Army Air Base, 10th Signal Platoon, Albuquerque, N. M., operates 7:30 to 11:00 A.M. and 1:00 to 12:00 P.M. daily.

— . . . —

ARRL Official Broadcasting Stations

THE FOLLOWING listed stations address information regularly "to all amateurs" rendering a distinct service to fellow amateurs. First information on F.C.C. orders, regulations, special tests and activities and timely data to the amateur world reaches amateurs first through League weekly Official Messages. Stations in all districts assure good coverage on the information which in many cases is so well sent it is used for code practice. Listen for the "QST" from these stations. Report results to the stations you copy too, so the operators will know their signals are successfully received and appreciated.

W1AAR, W1BVR, W1BWW, W1EAW, W1EHT, W1EFE, W1GAG, W1GDY, W1GOJ, W1GOU, W1HDJ, W1IDY, W1IP, W1JQD, W1KLV, W1KNJ, W1KTE, W1LKP, W1LMB, W1LMO, W1LOA, W1LOP, W1LZW, W1MQO, W1RP, W1WR.

W2AZV, W2CGG, W2EUK, W2FFF, W2HCV, W2HZL, W2IOP, W2JDC, W2JZX, W2MHW, W2MIO.

W3AEJ, W3AJA, W3AOC, W3AOJ, W3AQ, W3AQN, W3ASQ, W3BIG, W3BWT, W3CDQ, W3EQK, W3FJU, W3FME, W3FMR, W3GCU, W3GWQ, W3IAM, W3IDZ, W3INF, W3IOU, W3IU, W3IVN, W3JOI, W3UA.

W4ACZ, W4AXP, W4AZT, W4BHY, W4BQE/ANG, W4DAO, W4DGS, W4DLK, W4DMZ, W4DSY, W4EAY, W4EEE, W4EFD, W4FWD, W4GJW, W4PB, W4QL, W4TO.

W5BLQ, W5BUV, W5CJJ, W5DWW, W5ERV, W5FAB, W5FAR, W5FZJ, W5GED, W5GHF, W5GWL, W5HEJ/HEK, W5HHV, W5HME, W5HNW, W5HQC, W5HXI, W5IGW, W5IRO, W5KC, W5MH, W5MN.

W6AM, W6BAM, W6CFN/CVC, W6CHV, W6FBW, W6FHQ, W6IGO, W6ITH, W6JQB, W6KTY, W6LV, W6OMC, W6QKB, W6RQH, W6RIU, W6SPQ, W6TT.

W7EKT, W7GVH, W7HHH.

W8AHV, W8BWP, W8DED, W8DNO, W8DS, W8DXB, W8DZO, W8FGV, W8FZE, W8GJM, W8IAI, W8IOH, W8JTW, W8LUT, W8NDE, W8OTY, W8PER, W8PJJ, W8PQQ, W8PX, W8QFF, W8RAT, W8RBD, W8RBI, W8REC, W8RIS, W8ROA, W8SHW/SUS, W8SWF, W8TJY, W8USX, W8UUZ, W8UWZ, W8VAN, W8WF.

W9AEJ, W9ARI, W9AXH, W9BHY, W9BQF, W9CGK/5, W9DCW, W9DDF, W9DEA, W9DEI, W9DUD, W9DZC, W9ECL, W9EDW, W9EY, W9EMQ, W9FXM, W9GFA, W9GFL, W9GMI, W9HIC, W9HUX, W9IAW, W9INU, W9IUM, W9JWC, W9KEI, W9KKY, W9KOH, W9KXB, W9KYQ, W9MWR, W9OXC, W9PTY, W9QLZ, W9REF, W9RH, W9RIL, W9RPF, W9RSN, W9RUJ, W9UEU, W9VMI, W9VOA, W9VRZ, W9VVA, W9WKP, W9WMI, W9WTD, W9WVQ, W9WWL, W9YCF, W9YMV, W9YVF, W9YYA, W9ZGR, W9ZGX, W9ZVO.

K4KD.

W1AW SENDING PRACTICE SUBJECTS AND QUALIFYING RUNS

Daily-except-Friday W1AW Code Practice Starts at 9:45 P.M. EST.

Simultaneous transmission on: 1751, 3575, 7150, 14,254, 28,510, 58,960 kc.

The subjects given below will be followed each Sunday, Tuesday, and Thursday, October 21st to December 1st, and the text is identified to make sending practice available. To get sending help, hook up your own key and buzzer or audio oscillator, turn to the QST material, tune in W1AW, and attempt to send right in step with the tape signals. Adjust your spacing in the manner the received signal indicates necessary for improvement.

Subject of Practice text from October QST

Date

- *Oct. 21 Handle Your Traffic on 160, p. 11.
- *Oct. 23 A Band-Edge Spotting Oscillator, p. 32.
- *Oct. 26 The Secrets of Good Sending, p. 35.
- *Oct. 28 Antennas for Domestic Work, p. 38.
- *Oct. 30 In the Services, pp. 44-45.
- Nov. 2 *Daylight Qualifying run, 1:30 P.M. EST. Un-announced copy.*
- Nov. 2 "It Seems to Us—," p. 7.
- Nov. 4 Around the World With the Yankee, p. 9.
- Nov. 6 Around the World With the Yankee, first par., p. 11.
- Nov. 9 Around the World with the Yankee, second par., p. 13.
- Nov. 11 An 80-Watt All-Band Transmitter or Exciter, p. 15.
- Nov. 13 A Lecher Wire System for U.H.F. Freq. Measurement, p. 18.
- Nov. 16 The Decade Calibrator, p. 23.
- Nov. 18 YLRL, QRVI, p. 32.
- Nov. 23 *Evening Qualifying Run, 9:45 P.M. EST. Un-announced copy.*
- Nov. 25 YLRL, QRVI, last par., p. 34.
- Nov. 27 A 56-Mc. Transmitter for Mobile Work, p. 50.
- Nov. 30 An Inexpensive Automatic Line-Voltage Regulator, p. 26.

* September, 1941, QST

Eighth UHF Contest and Relay Scores

(Figures represent score and number of different stations worked. Letters indicate band or bands used. A for 56, B for 112 and C for 224 Mc.)

W2BZB	256-75-AB	W1BDI/1	54- 5-A
W9PK	170-20-AB	W6OVK	46- 3-A
W1IJ	160-27-AB	W2BQR/2	34- 4-A
W1LOW/1	156-15-ABC	W6GBN	34- 3-A
W8CVQ	136-11-AB	W9ARN	33-11-A
W2COT	119-26-A	W2LOS	26- 5-B
W3AXU	110-23-AB	W3AXC	18- 5-A
W2MIV	108-32-AB	W2DOG	8- 4-B
W2MQF	64-16-AB	W8TDJ	8- 6-A
W1MNV	57-19-B	W1INF	7- 5-A
W2LAU	57-40-B		

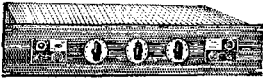

THE new Type SCR-2 Receiver which we describe below probably does not prove anything as far as amateurs are concerned, because it would probably give any ham claustrophobia to have to stay on a fixed frequency. One of the joys of operating is to try another frequency. However, we do think the SCR-2 is an interesting job for several reasons.

In *QST* last September we told how the straight amateur HRO had won laurels for itself outside of its intended field, in the British Admiralty, for instance. We boasted a bit over the fact that when National builds a receiver to high amateur standards, it will meet *any* standards. In a way this page is a postscript to September *QST*. We had a call for a crystal controlled single channel receiver with the performance of the HRO. Furthermore, it had to be so compact that it could mount on a 3½" panel. The only way we could accomplish this was to make it a special model of the HRO. This is how the SCR-2 came into being. Its circuit diagram and parts look very familiar to an old HRO man, and its performance is definitely of HRO calibre. Item: At a signal input of only 2.5 microvolts, the signal-to-noise ratio averages better than 10 db!

The SCR-2 uses a superheterodyne circuit with two RF stages preceding the first detector. The crystal oscillator may be of either the fundamental or the harmonic type, the latter being used for frequencies above 10 MC. This oscillator has extremely high stability. Since the transmitter will often have some frequency drift, the IF channel of the receiver is designed to have band pass characteristics. The band width is 4 KC for two times down, yet it is only 19 KC for 1000 times down. This takes care of transmitter drift very nicely, and yet gives excellent selectivity.

The SCR-2 has an extremely effective noise limiter of the series valve type. In addition to reducing noise, this same circuit acts as an AVC for CW signals. As such it will hold the output within 6 db for inputs from 1 microvolt to 1 volt. For phone, an unusually effective AVC circuit holds the output within 4 db over the same range.

Mechanically, the SCR-2 is unorthodox. It follows the club sandwich layout, with panel, power supply and receiver in three layers. This construction has many advantages. All RF and IF trimmers as well as the crystal are accessible from the back of the unit without removing it from the relay rack. Connections are made by plugs, so that the separate chassis are readily removable. We recommend this system highly to Ham constructors, because it combines extreme compactness with complete accessibility.

The SCR-2 is a fine performer in every sense of the word. It is a worthy son of its illustrious father.

W. A. READY



HALF A SEC OLD MAN..I'LL
SHOOT UP TO 160 METERS

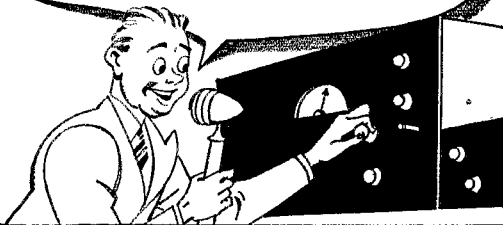

Work them wherever you
get through best... as
easy as tuning a receiver!

P. R. MALLORY & CO. Inc.
MALLORY

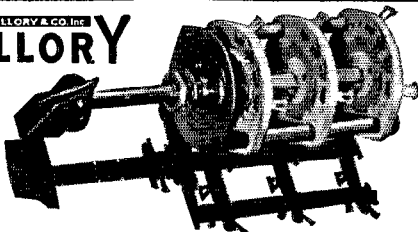

HamBand Switches

Band switching is easy when you use Mallory HamBand switches. Type 160C is designed especially for amateur service. It affords many exclusive, high efficiency features and assures long satisfactory life. Enjoy all the benefits of amateur radio transmission by making your rig flexible. Write for Form Y-646 which gives complete technical details.

P. R. MALLORY & CO. Inc.
MALLORY
PUSH BUTTON
Switches for
Many Purposes

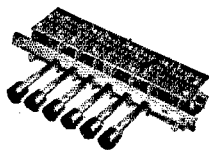

For meter switching and many other purposes, Mallory Push Button Switch Type 2190 offers a great many desirable features. Multiple circuits may be read with a single meter by merely pushing a button. In each case the other circuits remain closed and uninterrupted.

P. R. MALLORY & CO., Inc.
INDIANAPOLIS INDIANA
Cable Address—PELMALLO

Use

P. R. MALLORY & CO. Inc.
MALLORY
APPROVED
PRECISION PRODUCTS

Editorial

(Continued from page 9)

already more than cover the job. In others, new nets should be formed, particularly in states where there is already a heavy load of trainee traffic — the same fellows can't do all the work. In any event it seems desirable for these nets to drill in their state-defense status, so that not only the radio contacts but the necessary liaisons with local officials may be brought to complete reliability.

Local. The local work is just getting started; some cities haven't done much about it yet and most of them have simply counted on the wires and concentrated on their other tasks of organization. ARRL is just developing its own place in the OCD picture; announcements and more information are expected to follow soon. Our local contacts are logically based on a liaison between our resident Emergency Coördinator and the Local Defense Coördinator. Our ECs are being requested to establish these contacts and to do in this field precisely the thing they have prepared themselves to do in the field of disaster-emergency communication: coördinate the participation of all local amateurs. Those interested in joining this work, and who possess self-powered u.h.f. apparatus and the willingness to pledge themselves to join in the defense of their communities when needed, are invited to report themselves to their local EC. The ECs are preparing to make u.h.f. defense-communication registrations under a special certificate issued by our Communications Department. It is hoped that the organization can take shape rapidly.

The thing that impresses us most about this whole business is the prodigious need that will exist for more and more u.h.f. gear. We hear from England that that government has kicked itself time after time for not having encouraged more amateur u.h.f. work. The building now of 2½-meter apparatus in quantity seems the imperative ingredient in our fuller preparation. We urge it.

K. B. W.

Two U.H.F. Receivers Using the 9000 Series Tubes

(Continued from page 14)

the fine wire coils secure. This has the advantage that the fine wire coils can be trimmed by "peeling off" a small fraction of a turn at a time — the larger coils are trimmed by bringing back the last half turn through the *inside* of the coil. By moving this half turn around, the inductance of the coils can be adjusted over a range wide enough to allow the detector and r.f. circuits to track well over the whole band. This method of inductance trimming is shown on page 57 of the 1941 Handbook.

Still going **STRONG!**

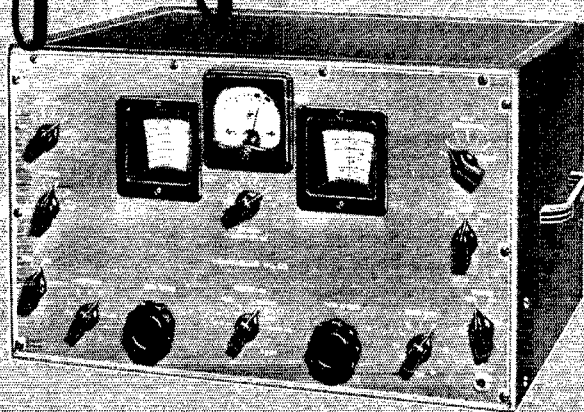

the HQ-120-X

IT'S NOT EASY these days to take care of our amateur friends with deliveries of HQ Receivers. We know many hams and short wave fans are disappointed with the slow deliveries but that is something we all have to tolerate. Any better delivery or new models would be at the expense of our defense effort and that is something which can't happen at Hammarlund. Speaking of new models, we don't think one is necessary. . . . We believe the HQ is still tops in its class and you'll find it well worth waiting for.

WRITE DEPT. Q-11 FOR BOOKLET

HAMMARLUND MFG. CO., INC.
424-438 WEST 33rd ST., NEW YORK

Pep-A-Plenty

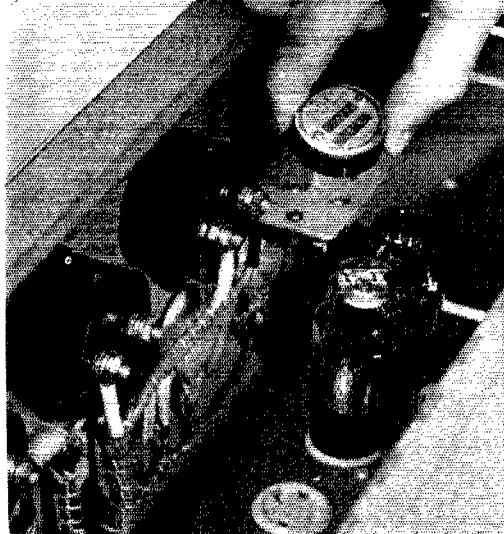

BLILEY CRYSTALS

THE signals of this transmitter are going to go places and do things. The sharp, clean-cut note, packed with punch, will be under the full supervision of the Bliley Crystal Unit being plugged in the socket.

Bliley Crystals have a way of getting the best out of any transmitter. Activity, keying, power-output, and dependability—characteristics that are necessary for above-the-average transmission—are deliberately developed to the highest practical degree.

If it's pep you want (and who doesn't), plug a Bliley Crystal in your transmitter. Your distributor has Circular A-8 giving complete descriptive data on Bliley Crystal Units for the various amateur bands.

BLILEY ELECTRIC CO.
UNION STATION BUILDING ERIE, PA.

The r.f. stage is trimmed by adjusting its trimmer condenser to the point where the regeneration control has to be set at a maximum. Either side of this point the control does not have to be advanced as far, and this indicates that the r.f. stage is not in resonance. When the r.f. and detector circuits are tracking well it will not be necessary to change the setting of the regeneration control more than 45° or so over the entire range. The bandwidth can be increased by using less inductance and more trimmer capacity—with the coil specifications given the band covers about 75% of the 100-division dial.

It will be noted that these coils do not have as many turns as others that are often used for 112-Mc. receivers. In fact, the circuits are relatively high-*C*, but this was done purposely because it added to the stability of the r.f. amplifier and the detector seemed to work a little better, possibly because of better coupling between r.f. and detector. With lower-*C* circuits the r.f. stage is likely to be highly regenerative, a condition which introduces serious body-capacity effects to the tuning and gain controls and is in general undesirable. An antenna circuit that doesn't load the r.f. stage heavily enough will still give these effects, and if one encounters them it is recommended that the antenna be tuned to load more heavily the r.f. input circuit. Tapping the grid of the r.f. tube down on the coil would probably cure any trouble from instability but it is impractical in this set-up. A two-wire line from the antenna will normally be best, and it should be tried with one side grounded or not, to see which gives the better coupling. In one instance where a single wire antenna was used, some instability of the r.f. amplifier was traced to the antenna wire running too close to the detector tube, and it is recommended that the antenna wire or wires be run away in such a fashion that there is no chance for coupling of this type.

General

In tests run on weak signals and harmonics from a signal generator, both receivers showed about equal sensitivity and compared quite favorably with a manufactured receiver of the same general type. However, the receiver with no r.f. stage radiated considerably and can cause as much QRM as any of the others of its type, and the addition of an r.f. stage is heartily recommended to anyone who would like to do his part in cleaning up the receiver QRM on 2½ meters. Although the simpler receiver, as shown, will only go up to about 260 Mc. or so, earlier versions of the receiver were made to operate around 85 cm. (350 Mc.), and it shouldn't be too difficult to get the 9002 to the ¾-meter band. The 9000 series should accelerate amateur development and occupation of our two highest-frequency bands to an even greater extent than the "acorn" tubes.



Photo by U.S. Army Signal Corps.

SERVICE **PLUS...** WITH "SUPER-PRO"

THE Super-Pro has always been popular because of its great versatility. You'll find Super-Pro Receivers in just about every branch of the communications field from mobile units to fixed observation posts and international press installations. The Super-Pro has found wide application in the diplomatic service of many foreign governments on every continent and in many branches of the United States

Government. Models are available to cover frequencies as low as 100 kc. and up to 40 megacycles.

MAIL COUPON TODAY!

HAMMARLUND MFG. CO., INC. Q-11
424 W. 33 Street, New York City

Please send "Super-Pro" booklet

Name.....

Address.....

City.....State.....



Canadian Office:
41 West Ave. No., Hamilton, Ont.

HAMMARLUND

EXPORT DEPARTMENT: 100 VARICK ST., NEW YORK CITY

1942

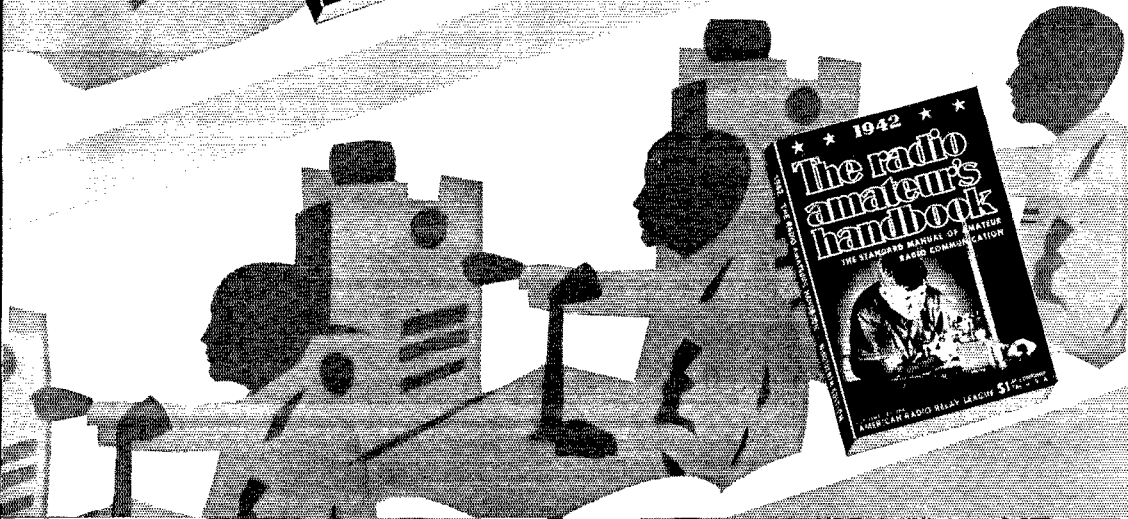
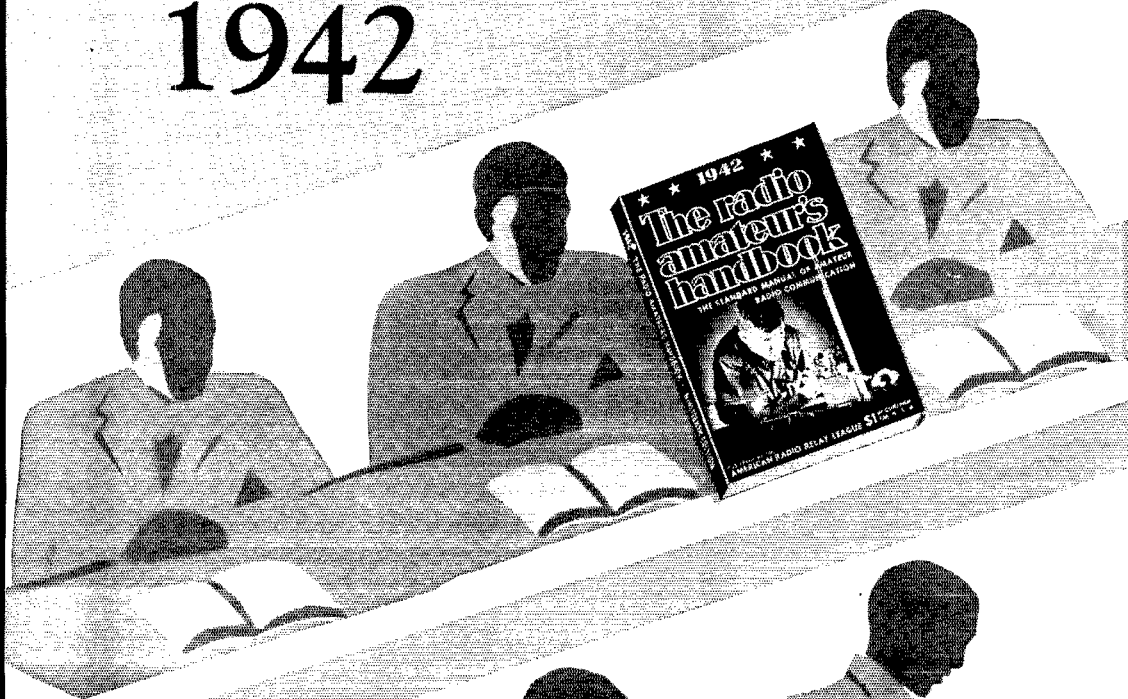

THEORY

CONSTRUCTION

OPERATING

THE NEW
RADIO AMATEUR'S
HANDBOOK

\$1 postpaid — \$1.50 outside continental U.S.A.

Buckram Bound, \$2.50

HARD TO GET? ...SORRY

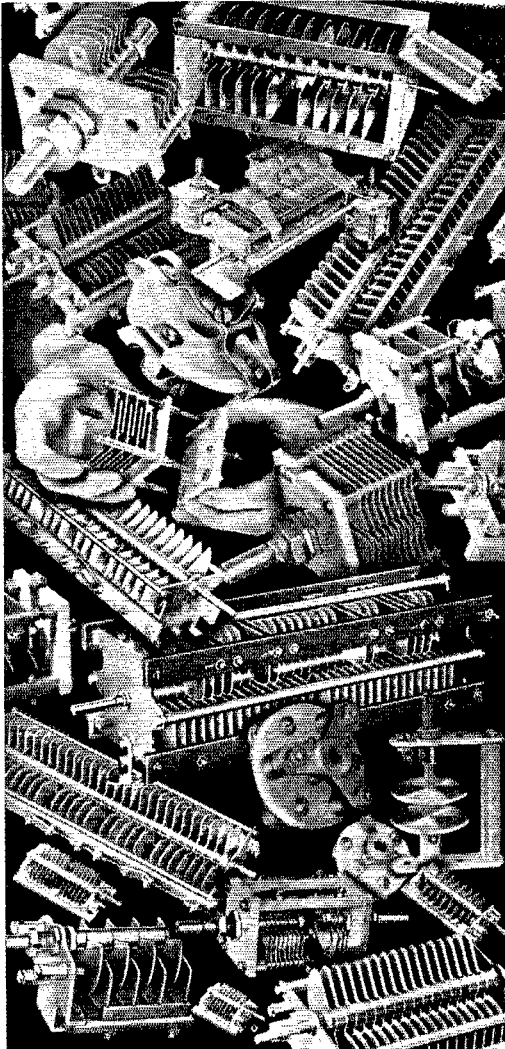

If your dealer says "sorry, they are on order but out of stock," when you ask for some CARDWELL product, don't blame him—it's probably our fault.

The demands on CARDWELL facilities by Uncle Sam must be met.

You have been very patient and understanding, for which we are grateful indeed. Your patience will be rewarded by improved CARDWELLS in the future.

**THE ALLEN D. CARDWELL
MANUFACTURING CORPORATION**
83 PROSPECT STREET • BROOKLYN NEW YORK

U. S. Antarctic Service

(Continued from page 17)

on the air in contact with KC4USA. Charlie has the greatest number of contacts (followed closely only by "Skunk" Scrivener, W3EXI).

Why the special test and observation skeds with W1FH? Well, I'll tell you — that's where Mama was. You see, in 1934 we were unable to work Boston on 20 meters from Little America. In 1940, 'twas no trouble at all.

Thanks a lot for the kind assistance rendered by you and your staff in handling our amateur business.

— Clay W. Bailey
Communications,
U. S. Antarctic Service

An Antenna Tuner

(Continued from page 20)

should be coupled to the end of the tank coil opposite to that to which the plate is connected. With balanced-output circuits, the link winding should be placed at the center of the tank coil. The link at the antenna tuner will always be placed at the center of the coil.

The tuning procedure with series tuning is as follows: With C_1 at minimum capacity, couple the antenna coil, L_1 , loosely to the transmitter output tank circuit, by using a single link turn at each end of the line, and observe the plate current. Then increase C_1 until a setting is reached which gives maximum plate current, indicating that the antenna system is in resonance with the transmitting frequency. Readjust the plate tank condenser to minimum plate current. This is necessary because tuning the antenna circuit will have some effect upon the tuning of the plate tank. The new minimum plate current will be higher than with the antenna system detuned, but should still be well below the rated value for the tube or tubes. Increase the coupling between the two circuits by adding link turns, one at a time at each end, each time retuning both antenna tuner and output tank until the minimum plate current is equal to the rated plate current for the output tube or tubes. Always use the degree of coupling which will just bring the plate current of the output stage to rated value when the antenna circuit is tuned through resonance.

With parallel tuning, the procedure is similar. When the correct degree of coupling has been attained, the simplest procedure is to tune the output tank to resonance with the antenna circuit well detuned and then swing the antenna tuning up to resonance. This procedure will cause the least detuning of the output stage, although the tuning of the latter should always be checked as the final adjustment.

R. F. Indicators

Feeder current, as indicated by the lamps, is useful for tuning purposes only and will not give an indication of the actual power output. When series tuning is used, the lamps should glow more brightly as the antenna is tuned to resonance and

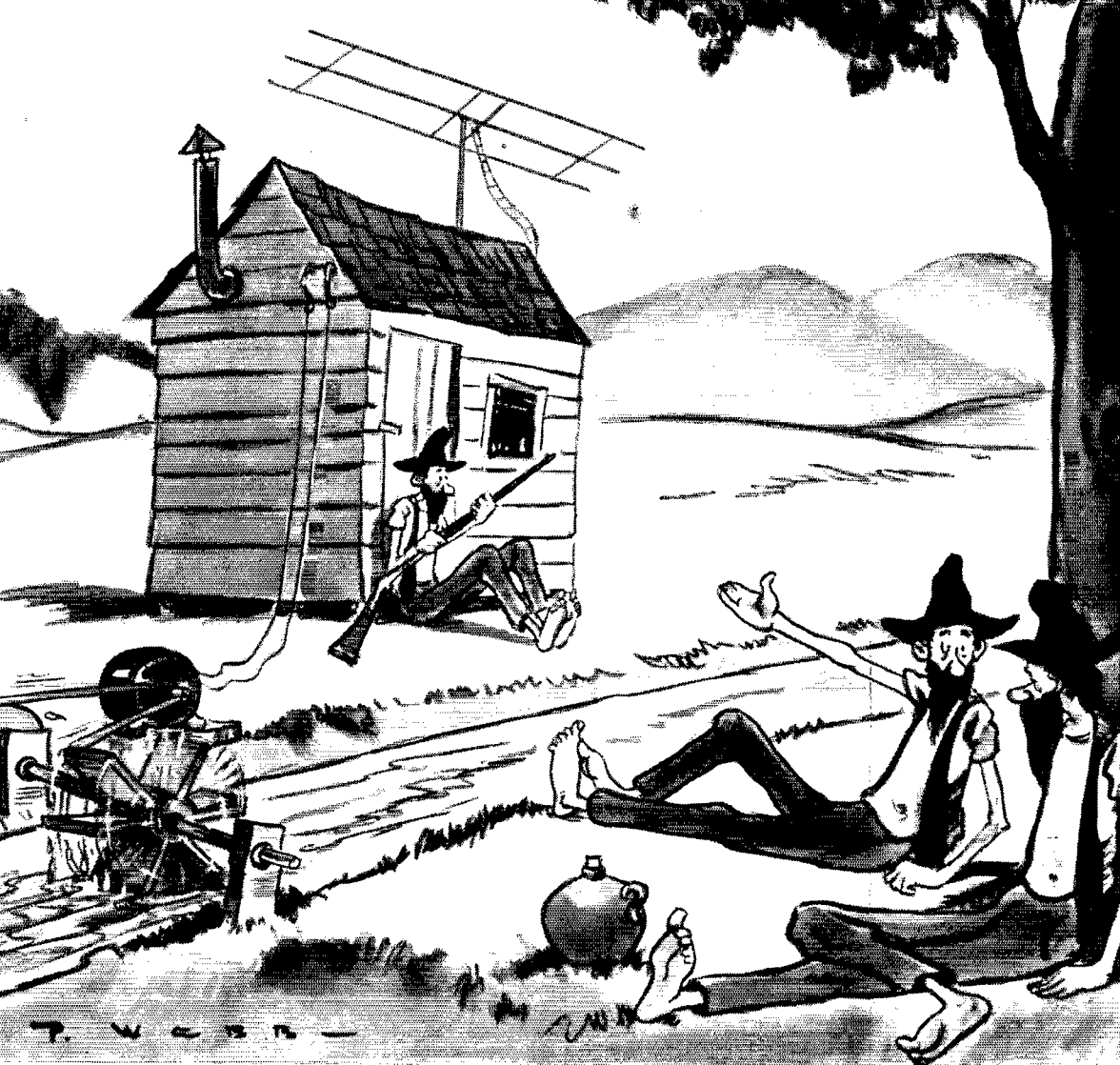

**"EVER SINCE HE GOT THEM NEW G-E CAPACITORS HE
WON'T LET NOBODY NEAR THE SHACK."**

Filter troubles take a beating when you install Pyranol* capacitors—a beating that lasts for years and years.

And here's some more good dope on Pyranols:

- ★ Continuous operation at 10% above rating
- ★ Long life, for low cost per service-year
- ★ Small size—means easy portability
- ★ Upright or inverted mounting
- ★ Round or rectangular cases
- ★ More than 50 ratings to choose from
- ★ More than a million units in service
- ★ Hermetically sealed for permanence

*Reg. U.S. Pat. Off.

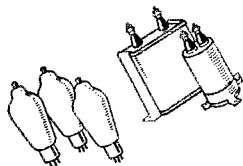

**NEXT TIME YOU
NEED TUBES—**

**GET G.E.'S
AND MEASURE
THE IMPROVEMENT**

FREE for your shack wall!

ENLARGEMENT OF THIS CARTOON,
drawn by Paul Webb of *ESQUIRE* fame,
reproduced on tapestry-finish paper.

Also

- GEA-3315B on G-E Transmitting Tubes
- GEA-2021B on G-E Pyranol Capacitors

General Electric, Section Q407-10, Schenectady, N.Y.

Please send me free the items checked.

Name.....

Address.....

City..... State.....

GENERAL  ELECTRIC

MEMO TO:

All Signal-Shifter Users

NOW is the time to complete the exciter of your transmitter!



By adding the "SIGNAL SPOTTER"

Your Signal Shifter was the best investment you ever made for the improvement of your station! It's ability to place a T9X signal on any frequency is worth real dough! It's still mighty convenient, tho. to switch back to spot-frequency operation with crystal control—for "band-edge" operation, Army and Navy networks, traffic skeds, etc. The Signal Spotter provides excitation on four fixed frequencies; has sockets for four mounted crystals, selected by a switch on the panel. Connects to the Signal Shifter by handy cable in rear and matches it perfectly in size and finish. Don't wait until it's too late—see your Jobber TODAY!

SIGNAL SPOTTER, Complete with tubes, Model 9-1044. Amateur Net . . . \$24.75

Write for Free Complete Catalog!

Dept. Q-11

 **Meissner** MT. CARMEL, ILLINOIS
"PRECISION-BUILT PRODUCTS"

the coupling is increased. Tuning should be started with all four lamps in the sockets. If no indication is obtained with the antenna tuned, the bulbs should be unscrewed, one at a time, until an indication is obtained. If a single lamp shows sufficient brightness to be in danger of burning out, another should be inserted in the circuit. Greatest output will be obtained with the lamp or lamps glowing most brightly. When the antenna tuning is complete, the lamps should be short-circuited with a clip to eliminate the power consumed by them.

With parallel tuning, the lamps will seldom be of great value, since they are then near a point on the feeders of maximum voltage and minimum current. In this case, the neon bulb will probably be a more useful indicator. With the antenna circuit tuned to resonance as indicated by the plate current, the grounded metal piece X should be bent toward the neon bulb until it ignites. The bulb will glow most brightly when the transmitter is delivering the greatest output. The distance between the neon bulb and the metal piece should be adjusted for best indication.

Harmonic Operation of Antennas

Any of the antenna dimensions given in the charts will be satisfactory if the antenna is operated at harmonics of the frequency for which it is cut. Parallel tuning will always be used for harmonic operation. A tank coil suitable for the harmonic frequency should, of course, be employed when operating at the harmonic.



—D. H. M.

What the League Is Doing

(Continued from page 21)

numerous W7 amateurs, considering that Section 2.91 gave them that authority. As it is reported to us, some of the amateurs operated at addresses other than the licensed ones, including the moving of their portable equipment to Army locations contrary to Order No. 73. The Seattle R. I. started citing amateurs and finally descended upon the scene with fire in his eye but, after going into a huddle which showed that all concerned had acted in good faith because of the language of 2.91, the citations were squashed.

The matter has now become the subject of an understanding between the War Department and FCC. It is henceforth to be understood by all concerned that before Army field commanders can secure the participation of amateurs in Army communication systems, they must get the approval of the War Department at Washington and, at the latter's request, the issuance to the amateur by FCC of special temporary authority.

 **Strays** 

October Harper's has a grand article on "Our Radio Amateurs," by Carl Dreher and Zeh Bouck. Good publicity for us with the general public, you'll enjoy it yourself.

Quick HOUR SERVICE

ON EVERYTHING YOU ORDER FROM THIS AD!

SX-28 by Hallicrafters.
\$44.88 Down; \$17.84 per month for 8 months. Cash Price \$179.50 less speaker. Regular PM23 Speaker in Metal Cabinet \$15.00.

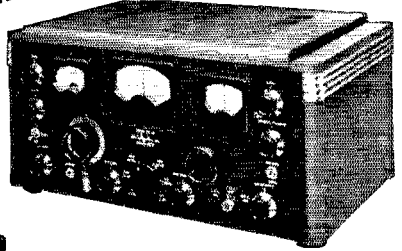

← NATIONAL NC 200
\$43.62 Down, \$17.34 per month for 8 months. Cash Price \$174.50 Complete.

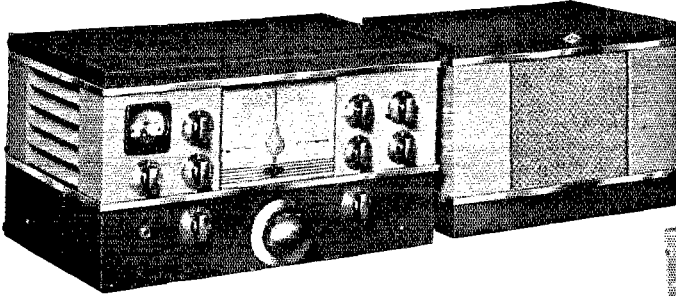

HAMMARLUND HQ 120X — \$42 DOWN

Balance \$16.69 Per Month for 8 Months. Cash Price \$168.00 Complete. Send Down Payment and Credit References with Order.

High Voltage Power TRANSFORMERS



Newark's larger volume of amateur business makes this unmatched value possible. Made by one of the largest transformer manufacturers. These husky transformers have a place in every Ham Rig. Guaranteed. As illustrated. Five Filament Types.

QUANTITIES LIMITED

- No. 3094 — 350-0-350...150 Ma. 5 V.-3 amp; 5 V.-3 amp; 2 1/2 V.-3 amp; 2 1/2 V.-7 amp. **\$1.75**
- No. 1549 — 300-0-300...100 Ma. 6.3 V.-3 amp; 5.0 V.-3 amp. **\$1.95**
- No. 1547 — 362-0-362...225 Ma. 6.3 V.-3 amp CT; 6.3 V.-3 amp; 5 V.-6 amp. **\$2.45**
- No. 4140 — 600-0-600 V.—200 Ma. Filaments; 7.5 V.C.T.—3 A.—5.0 V.C.T.—3 A.—2.5 V.C.T.—10 A. Wt. 8 1/2 lbs. **\$3.45**
- No. 4240 — 600-0-600 V.—200 Ma. Filaments; 6.3 V.—4 A.—6.3 V.—3 A.—5.0 V.—3 A. Wt. 8 1/2 lbs. **\$3.45**

PRICES WILL NEVER BE LESS!

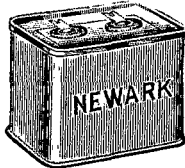

As Low **59¢** as

OIL FILLED — OIL IMPREGNATED FILTER CONDENSERS

The lowest price NEWARK has ever featured... on a condenser value that already has made thousands of friends for us! Quality-built by reliable maker. Guaranteed at rated voltage.

Volts Mtd. DC.	Size	Price
1 1000	5 x 3 1/4 x 1 1/4	\$.59
18.3 1000		2.15
8 2000	5 x 3 1/4 x 3 1/4	2.75
4 3000	5 x 3 1/4 x 3 1/4	3.75

DISPLAY YOUR CALL LETTERS in Gold, 10¢

Big shadowed decals, nearly 2" high. For ham shack door, windshield etc. Be sure to give your call letters.

BRAND NEW CATALOG

Write for yours now. Get it fresh and new, soon as the ink is dry!

FREE!

SAVE \$\$\$... Buy from Newark NOW
Prices are ON THE WAY UP!

NEWARK Electric Company

323 W. MADISON ST.
Dept. Q CHICAGO, ILL.

SOLAR

A CHAIN IS ONLY AS STRONG AS ITS WEAKEST LINK

Make every condenser "link" in your circuits strong . . . standardize on SOLAR for safety!

Send for our new catalog No. 11 and other literature

SOLAR Mfg. Corp.
Bayonne, N. J.

Pacific Division Convention

Fresno, California, November 8th-9th

THE San Joaquin Valley Radio Club of Fresno, California, this year is sponsoring the Pacific Division ARRL Convention on November 8 and 9, 1941. A two-day program will consist of many interesting highlights and plenty of entertainment, including a caravan trip to Friant Dam, now under construction.

The program includes a dance, floor show, code tests, group breakfast, 2½-meter hidden transmitter hunt, technical talks, demonstrations, ARRL open forum, trip to the world's largest winery, and banquet. An elaborate program is planned for the ladies by Genevieve Sheetz, W6QVK.

The registration fee is \$3.00 in advance by mail. For tickets or additional information address Carl F. Wilkinson, W6SRC, Registration Chairman, P. O. Box 621, Fresno, California. Pre-registration closes at midnight of November 6th.

Code Proficiency Runs

PRACTICE transmissions are sent nightly, except Friday, from W1AW. These start at 9:45 P.M. EST (8:45 P.M. CST, 7:45 P.M. MST, 6:45 P.M. PST) using 1762, 3575, 7150, 14,253, 28,510 and 58,970 kcs. (simultaneous transmission). Approximately 10 minutes' practice is sent at progressive speeds of 15-20-25-30-35 words per minute. One can also get 15-, 20-, or 25-w.p.m. practice from W1AW's official messages "to all radio amateurs" which start at 8:30 P.M. and midnight EST daily.

Opportunity for getting the League's Code Proficiency Certificate Award (or endorsement stickers for increases) will be given in the next qualifying runs, as follows:

Nov. 2nd (Sun.), 1:30 P.M. EST (Text at 1:45 P.M. EST)
Nov. 23rd (Sun.), 9:45 P.M. EST (Text at 10 P.M. EST)

Copy the test text at the best speed you can. To be acceptable for checking copies must be postmarked before the next following qualifying run. Underline the full minute of perfect copy necessary to qualify at any speed. Tell us if you copied by ear without help except for your pencil or mill (mention which used), and if you are working for first certificate or endorsement. Send in copy and statement. Mark your envelope to ARRL "Code Proficiency Copy."

Note "press," W9HCC, and W6AM schedules and frequencies on page 66 October QST. Get in on practice and qualifying runs. Start after one of those fine operating achievement awards today if you haven't yours yet. Every FCC amateur licensee is eligible.

— F. E. H.

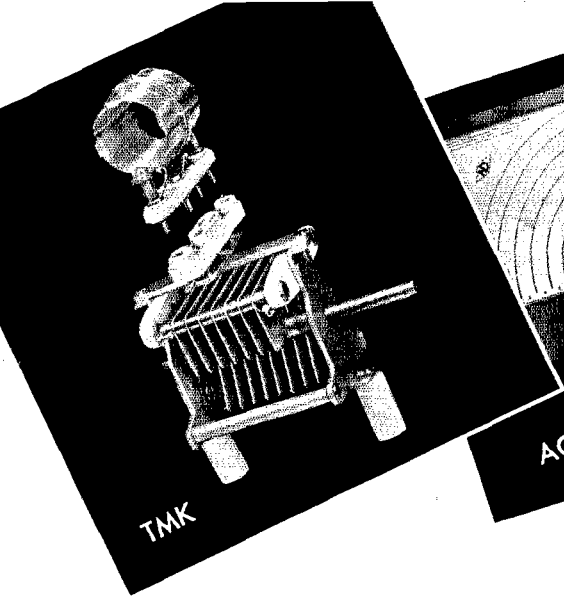

TMK

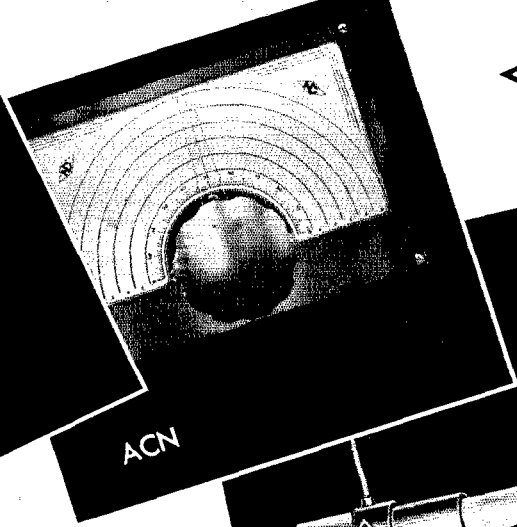

ACN

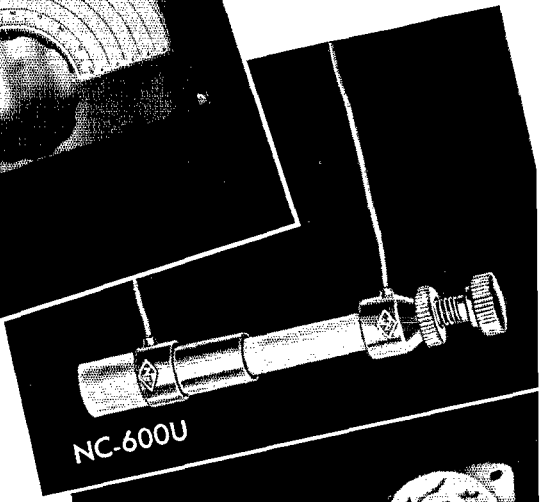

NC-600U

PARTS TO MAKE THE RIG BETTER

TMK ● A compact and efficient condenser for exciters and low powered transmitters which features a swivel coil mount for air-spaced, plug-in AR-16 coils. For panel or stand-off mounting.

ACN ● The dial designed for direct calibration. Index holes in the pointer allow calibration points to be pricked on to the blank scale, which is removable for inking in. The mechanism is not disturbed when the scale is removed. The Vernier Drive Unit has a ratio of five to one.

NC-600U ● An outstanding convenient neutralizer for low power beam tubes requiring from 0.5 to 4 mmf, and 1500 peak volts such as the 6L6. The stand-off insulator is removable for pigtail mounting.

SOCKETS ● XM-50 is a husky metal shell socket for tubes having the Jumbo 4-pin base. JX-100 is a big low-loss wafer socket for the 803, RK-28 and other tubes having the Giant 5-pin base. CIR sockets feature low loss Isolantite or Steatite insulation, a positive contact, and a metal ring for six-position mounting. These are but a few of National's twenty different sockets.

CHOKES ● R-100U is a compact little RF choke with removable stand-off insulator, electrically identical to the famous R-100. R-152 is the big brother of the R-100 with a current rating of 600 MA. R-175 is National's newest choke, suitable for parallel feed as well as series feed in transmitters. Ratings on these as well as other National chokes are given in the new National Catalogue.

TCN ● a husky neutralizing condenser for 203A, 211 and similar tubes.



XM-50



CIR-6



JX-100

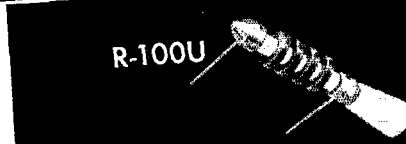

R-100U



R-152

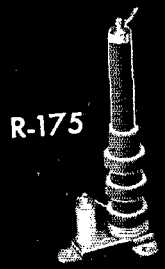

R-175

NATIONAL COMPANY, INC. MALDEN, MASS.

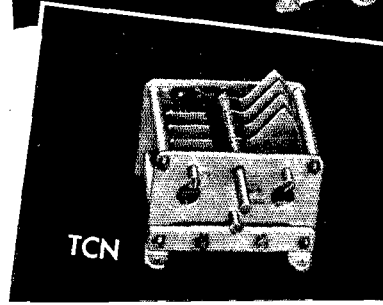

TCN



E. H. Rietzke
Pres. CREI

Here's How You Can Qualify for a BETTER RADIO JOB



CREI Technical Training is Preparing Others for Good-Paying Radio Jobs — WHY NOT YOU?

Are you finding yourself in a routine job — a job that any other man can handle just as well as you? Are you plodding along while others are advancing to important, secure engineering positions? Today, radio JOBS are many — but radio CAREERS are few! Right now is the opportune time for *you* to equip yourself with the necessary *technical training* to qualify you for an *important* engineering position with a sound future.

Prepare NOW for a Secure and Lasting CAREER in the Expanding Radio Industry

Now when industry *needs* men is the time for you to invest in radio career training. Your radio experience backed by modern CREI technical training will equip you to share in the good-paying jobs that await trained men. CREI home study courses in Practical Radio Engineering are prepared for *experienced radiomen* who realize not only the value, but the *necessity* of CREI training if they are to rise above the routine jobs to make good in the important positions that lead to security and happiness!

WRITE FOR FACTS TODAY!

Our free booklet and personal recommendations may hold the answer to your future success. In your inquiry please state briefly your background, education, present position—and whether you are interested in Home Study or Residence training.



CAPITOL RADIO ENGINEERING INSTITUTE

Dept. Q-11, 3224 16th St. N. W.

Washington, D. C.

Silent Keys

It is with deep regret that we record the passing of these amateurs:

- Robert W. Conn, W1KZR, Southbury, Conn.
- William G. Cram, W9BVR, Milwaukee, Wis.
- Dayton P. Frackleton, W6HKB, Eagle Rock, Calif.
- Charles E. Gott, W9MXZ, New Ross, Ind.
- Harry E. Howell, W8QFV, Blacklick, Ohio
- Alton R. Janelle, W9CEA, Green Bay, Wis.
- James W. Knight, jr., W6MOS, Lynwood, Calif.
- Sgt. Miles MacDonnell, VE3AKM, Toronto, Ont.
- Ernest E. Pringle, W9UPY, Kansas City, Mo.
- John Robins, VE4FR, Edmonton, Alta.

A Soldier's Portable

(Continued from page 25)

ventilating holes in the cabinet with large washers to keep the screws from slipping through. The condenser is mounted with two pieces of No. 12 copper wire used as supports. The soldered joints must be plenty solid to keep the condenser from wobbling around. The coils use banana plugs and the insulators are spaced so the plugs fit. The method is makeshift but in practice it works well so long as the soldering is solid. The link from the final to the antenna coil runs down through the slot in the back of the cabinet and up to the coil. It sounds long, but actually it's only 6 inches. So far each location has yielded a different type of antenna and all get plenty of soup without any other tuning. A 66-foot Zepp, a 134-foot Zepp, a vertical and a 134-foot single-wire fed have been used and all worked fine.

Tuning

This is the toughest job connected with the rig. It's caused by the fact that unless stern methods are employed the 6L6 will go galloping up and down with little or no regard for band edges. The oscillator, however, is easy. Use a neon bulb or flashlamp and loop as a resonance indicator and the handy-dandy tuning stick to rotate the trimmers. It's best to tune up on 20 meters first. Using a 40-meter crystal and 40-meter coil in the first triode section of the 6N7 and the 20-meter coil in the second section, the voltage is applied by pulling the keying plug out of the jack and inserting the dummy plug in the final jack. The trimmer is rotated until an indication of resonance appears in the oscillator circuit. Now move over and do the same to the second triode, which is doubling to 20. Next, the 6L6 is neutralized on the nose with the neutralizing condenser. If fate

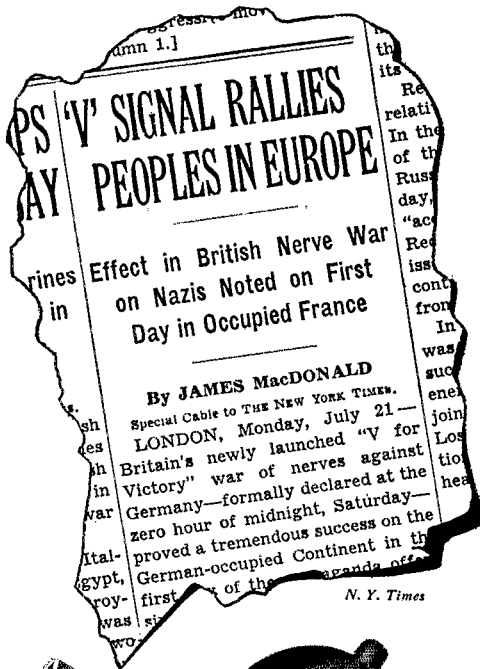

"V for Victory" is a call for SPEER Graphite Anodes

Use tubes with SPEER Graphite Anodes to assure victory over the tyranny of anode-conquering heat. Of all anode materials, graphite is the only one that heat cannot fuse — cannot even soften or warp.

Not only does graphite withstand heat as no other anode material can, but it also sheds heat — has many times the relative heat-dissipating value.

For longest service-life and power, use tubes with SPEER Graphite Anodes. Leading tube manufacturers can supply you. Write for list and SPEER Graphite Anode Booklet.

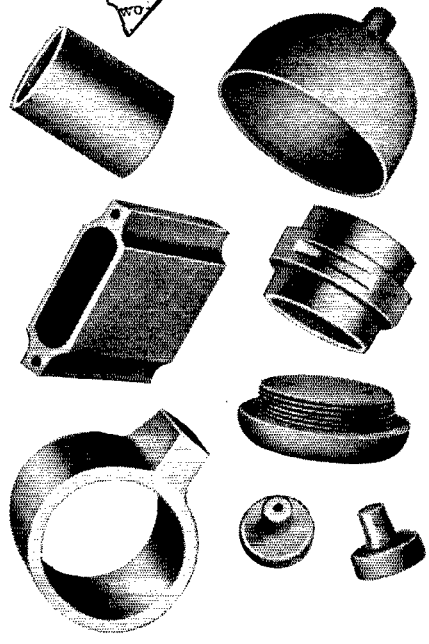

SPEER CARBON CO. 
 ST. MARYS, PA.

Here is Everything You Need to Know to be a Radio Amateur . . .

156 PAGES! OVER 100 PICTURES!

EASY TO
READ!

★ ★ ★

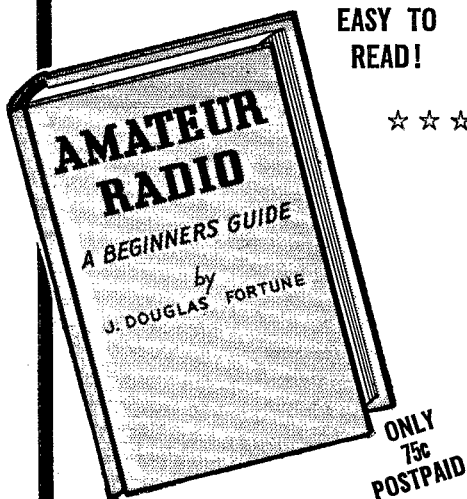

★ ★ ★ Takes you step-by-step through everything you need to know to be an amateur and have your own radio station. Written so anyone can easily follow the instructions, this textbook is a great help to the beginner or the full-fledged amateur.

★ ★ ★ You can learn how to build your first transmitter and receiver—how to learn code—how to get your license—how to use your beginning equipment in building larger and more advanced rigs. Here is radio theory really made understandable.

Bound in cloth and stamped in gold. Obtain a copy from your Radio Parts Distributor, or write direct to THORDARSON.

THORDARSON

ELECTRIC MFG. CO.

500 West Huron Street, Chicago

"Transformer Specialists Since 1895"

has been kind (which it wasn't to me), the neutralizing will hold for all bands, but the results of extensive experiments show that fate and the stars control the grid to plate capacity. Therefore on 40, 80 and 160 the 6L6 just has to have the plate tuned to exact resonance and you have to be sure that the resonance peak is the right one. I've found that by juggling the components the difference can be reduced to such a small capacity that one setting of the neutralizing condenser holds for all bands. Actually the problem isn't as bad as it sounds. I haven't touched the neutralizing for months and the 6L6 has yet to take off and go on a solo march, and I've changed bands and tuned up in the dark plenty of times. Just be sure the plate tuning is on the nose and it'll be OK.

Operation

The transmitter I had before I built this one was a kilowatt job and I figured it would require a lot of fortitude to keep chin up and stick it out with a peanut whistle like this. That's where I was wrong. From Ohio, K6, K7, K4 and all W districts were worked on 20 and 40. On 80, wonder of wonders, all W call areas were worked. On ten, using the 6L6 as a doubling final, S9's from W6 (on sked) were common. On 160 W1UE was the best DX, although I only operated on that band one evening and got in only seven contacts. From Camp Forrest, Tenn., the west and east coasts were easy on both 40 and 80. In operation the r.f. unit is piled on top of the power supply since there is no need to open the lid of the latter.

All of this leads up to a big letdown, something I decided when the rig was first put on the air in Ohio. The receiver just isn't good enough when room is available for something better. I fought around with the two-tuber trying to make it work like an HRO, but no sale. Therefore I gathered my pennies together, sold some equipment and bought a battery-a.c./d.c. super which works fine along with this rig. It's small enough to fit into that same much-abused foot locker and it will operate anywhere the transmitter will. When I'm at a place where space is so limited that the super cannot be used I use the little fellow and, so far, QRM has never been so bad that the only way out was to QRT. It's really nice to have the whole station contained in two cabinets, but sometimes it's necessary to give up a luxury for a necessity. All points considered I'm plenty pleased with both the transmitter and receiver. After all, can you roll your rig around the floor, drop it a few times, set it up in an 8 × 12 inch space and then plug it in and keep skeds? I can!

Strays

The Academy of Model Aeronautics, the national model-builders' organization, is compiling a list of those active in radio control of model aircraft. If you are interested in this hobby, send your name to the secretary of the Academy, Albert L. Lewis, Willard Hotel, Washington, D. C. A copy of the completed list will be supplied gratis to all who register their interest.

I

in the considered judgment of leading engineers...

When important decisions are made about vacuum tubes it is not uncommon for an Eimac tube to win the honors. Reason: the designers of Eimac tubes have consistently held as their objective the anticipation of the future requirements of the radio industry. Efforts have not been confined to the production of a tube for yesterday's requirements.

This policy has kept Eimac tubes ahead of the industry... a factor that is logical because the efficiency and progress of radio depends almost entirely upon the development of new ideas...new improvements in vacuum tube performance. Take the Eimac 250T, for example, which now possesses the most recently developed refinements. Check these features illustrated below and then check the performance of Eimac tubes in your transmitter. You'll see then why Eimac tubes are to be found in most of the important new developments in radio.

Follow the leaders to **Eimac**
TUBES

Eitel-McCullough, Inc.
San Bruno, Calif.

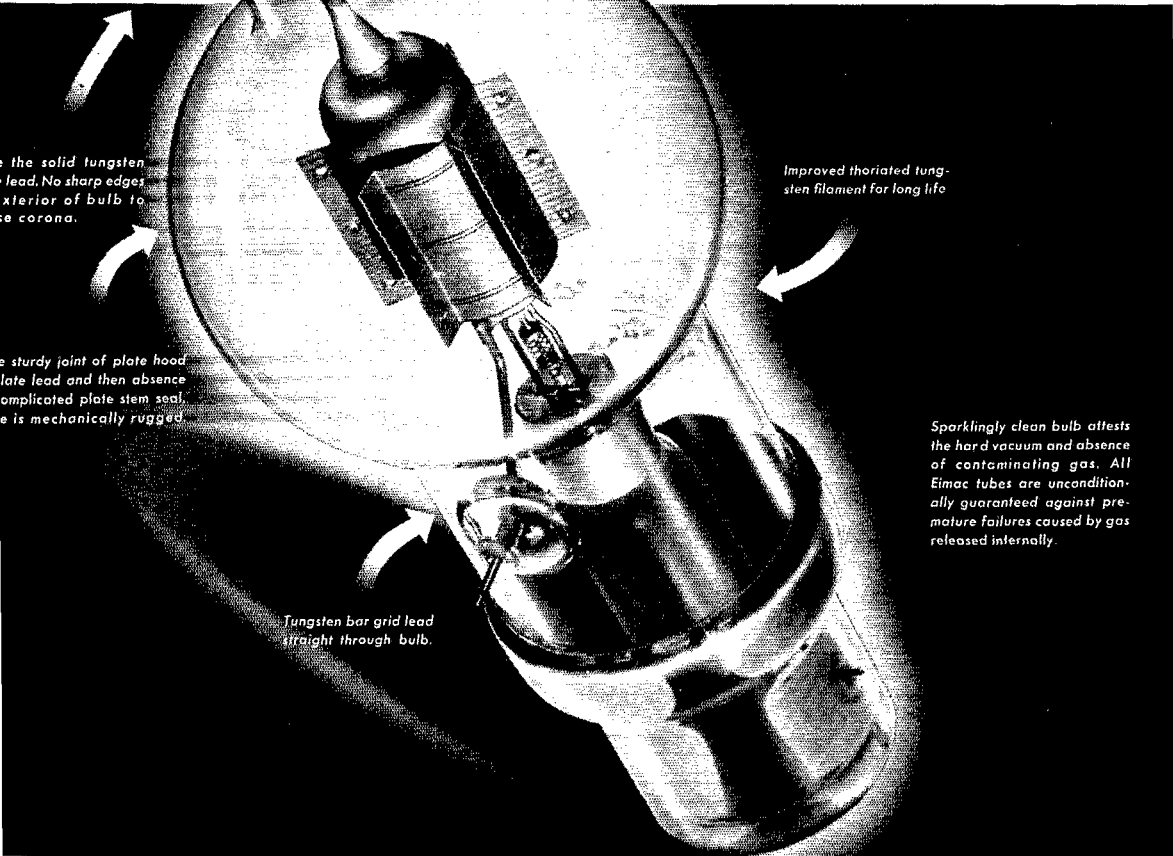

the solid tungsten lead. No sharp edges exterior of bulb to the corona.

Improved thoriated tungsten filament for long life

the sturdy joint of plate hood late lead and then absence complicated plate stem seal. is mechanically rugged.

Sparklingly clean bulb attests the hard vacuum and absence of contaminating gas. All Eimac tubes are unconditionally guaranteed against premature failures caused by gas released internally.

Tungsten bar grid lead straight through bulb.

EIMAC REPRESENTATIVES

California, Nevada
HERB BECKER, 1530 W.
104th St., Los Angeles, Cal.
N. Y., N. J., Penn., Md., Del.,
Dist. of Col., Maine, N. H.,
R. I., Conn., Mass.
ADOLPH SCHWARTZ, 262
Grayson Place, Teaneck, New
Jersey.

Wash., Ore., Idaho, Mont.
GENERAL SALES CO.,
Verner O. Jensen, 2605-07
Second Ave., Seattle, Wash.
Colo., Wyo., New Mexico,
Arizona, Utah
RICHARD A. HYDE, 4253
Quitman St., Denver, Colo.

Chicago, Illinois, Wisconsin
G. G. RYAN, 549 W.
Washington Blvd., Chicago,
Ill.
N. Caro., S. Caro., Georgia,
Tenn., Flor., Ala., Miss.
JAMES MILLAR, 316 Ninth
St. N. E., Atlanta, Georgia.

Texas, La., Okla., Ark.
J. EARL SMITH, 2821 Live
Oak St., Dallas, Texas.
Ohio, Mich., Ky., Ind., Minn.,
Mo., Kan., Neb., Iowa
PEEL SALES ENGINEER-
ING CO., E. R. Peel, 154
E. Erie St., Chicago, Ill.

Export Agents: Frazar & Co., Ltd., 301 Clay Street, San Francisco

RADIO TRAINING



FOUNDED IN 1909

PORT ARTHUR COLLEGE, a non-profit-making educational institution, offers a practical radio operator's course at the lowest tuition price in its history. Each radio graduate receives two months' actual operating experience at the college's commercial broadcasting station KPAC. This station is equipped with the latest type 1000 watt high fidelity RCA transmitter — 1250 kc. — directional antenna system. KPAC operates in new modern studios located on the campus.

The college has never advertised jobs or positions in lieu of education. Today it is well known there is a shortage of radio operators in every branch of radio; particularly flight and ground operators for airlines in America and South America — marine operators for ships traveling coastwise and foreign — geodetic-geographic research — broadcast stations — the Army and Navy — other positions in many departments of the United States Government. Therefore, we believe it is good common sense to mention that Port Arthur College is the sole radio school in America which owns a commercial broadcasting station with commercial advertising representatives in New York, Chicago, San Francisco, and many of America's leading cities, with active membership in the National Association of Broadcasters, and Broadcast Music Incorporated. Through these contacts the college receives from the broadcast industry alone more calls for radio operators than it is possible to supply.

AUTHORIZED TO TEACH RCA TEXTS

If interested, write for Bulletin R

PORT ARTHUR COLLEGE
PORT ARTHUR (World-Known Port)
TEXAS

CRYSTALS by HIPOWER

The Hipower Crystal Company, one of America's oldest and largest manufacturers of precision crystal units, is able to offer the amateur and manufacturer attractive prices because of their large production and the exclusive Hipower grinding process. Whatever your crystal need may be, Hipower can supply it. Write today for full information.

HIPOWER CRYSTAL CO.

Sales Division—205 W. Wacker Drive, Chicago
 Factory—2035 Charleston Street, Chicago, Ill.

LEARN CODE THE WAY YOU'LL USE IT — BY HEARING IT

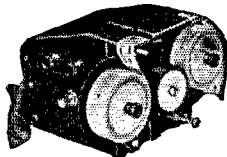

Type J - \$12.50

Sends 6 to 65 words per minute. Built-in tape perforator. Cut your own practice and message tapes. Complete with one roll of practice tape covering Alphabet, Numerals, Words to five letters; and 5 rolls of blank tape.

If your dealer can't supply you, write us

GARDINER-LEVERING CO. Haddon Heights
 New Jersey, U. S. A.

Type S - \$17.50

Sends from 4 to 40 words per minute. Higher speeds if desired. Complete with 10 rolls of double-perforated lesson tape of carefully selected and arranged matter for speediest results in learning code. Most compact and practical code teacher on market.

A Low-C Electron-Coupled Oscillator

(Continued from page 27)

is employed. The measurements were made by beating the output of the unit, tuned to 3540 kc., against the third harmonic of WHAM on 1180 kc. The e.c.o. was set 400 cycles lower than 3540 kc. by comparing the beat note with 400-cycle output from a calibrated variable audio oscillator. As the beat note drifted from 400 cycles it was followed with the audio oscillator to obtain the points for the curve.

In operating straight through on 160 meters there is a 200-cycle change in frequency when the buffer is tuned through the oscillator frequency. When the buffer is tuned to the second harmonic of the oscillator the frequency change is approximately five to ten cycles. The operation in this respect can be improved by using a tube with better internal shielding than the 6F6 in the oscillator circuit; the 6SK7 or similar types would be suitable.

This e.c.o. has been used since last winter for both c.w. and 'phone. On 75-meter 'phone the excitation is sufficient to drive a 6L6G, which in turn drives an RK-38 running 350 watts input. For 80-meter c.w. the oscillator is keyed by breaking the cathode circuit, as indicated in Fig. 1. Keying is positive and there is no observable chirp ever when listening to the ten-meter harmonic.

More Meaning in Reports

(Continued from page 55)

for example, then all signals that would normally be below this value will read something over S5 and the whole S0 to S9 range is contracted into an actual range of S5 to S9. Obviously this will result in unduly flattering reports on all signals below the vicinity of S9.

This may also lead to erroneous conclusions as to existing noise levels. If the receiver reads S5 with no signal tuned in, this is often taken as the measure of existing noise. Before arriving at this conclusion it is well to disconnect the antenna and make sure the zero adjustment is properly made.

S-Meter Circuits

It is universal practice to connect the S meter at some point in the receiver circuit where variations in the a.v.c. voltage will cause variations in the current flow through the meter. The most common arrangement is to connect it in series with the plate-voltage supply to one or more of the controlled tubes. As signals cause the a.v.c. voltage to vary, the plate current of the controlled tubes will likewise vary. In a few models a separate meter tube is employed, in which case this tube and the meter become the equivalent of a vacuum-tube voltmeter permanently connected across the a.v.c. system and showing variations in the applied control voltage.

In commercial receivers the meter is usually a

Centralab

The Quality Line

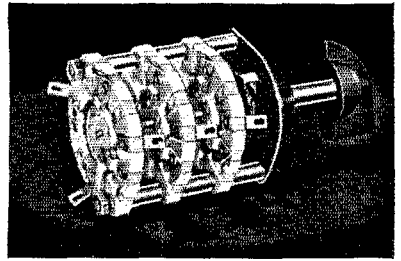

SELECTOR SWITCH

Available in an almost infinite variety of combinations . . . in bakelite or steatite . . . in single or multiple gang . . . from two to eleven positions on any one switch . . . also available for use in amateur transmitters.

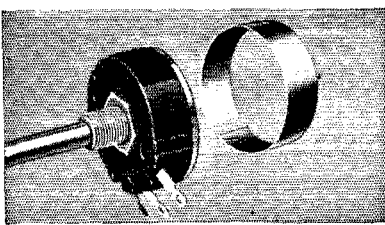

STANDARD RADIOHM

Wall type resistor. Exclusive non-rubbing contact band. 1 3/8" diameter x 9/16" deep. Available single, twin or triple, plain or tapped . . . with S.P.S.T., D.P.S.T. or S.P.D.T.

Hams, Servicemen, Experimenters and Manufacturers appreciate the utter dependability of Centralab products. Since 1922 more than a hundred million radio parts bespeak the universal acceptance accorded Centralab products. Send for catalog if your jobber cannot supply you.

CENTRALAB
Div. of Globe-Union Inc.
MILWAUKEE

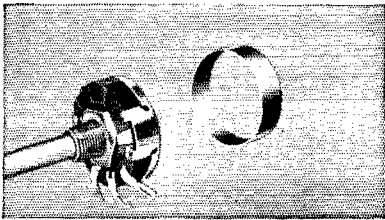

MIDGET RADIOHM

Companion to "standard" . . . small size but large control efficiency. Available single, dual or triple . . . plain or one, two or three taps . . . with S.P.S.T., S.P.D.T., or D.P.S.T. Moulded bakelite case, 1 1/8" diameter, 1/4" metal shaft 3 3/8" long.

WIRE WOUND RADIOHMS

In values from 2 to 10,000 ohms . . . insulated construction . . . 3 watts . . . universal shaft for all replacements . . . regular Radiohm switch covers may be attached . . . in linear curve only . . .

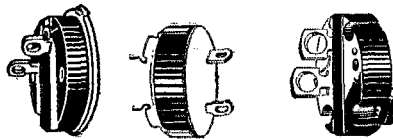

ATTACHABLE SWITCH COVERS

For standard and wirewound resistors (Radiohms) as well as Midget and Elf Radiohms . . . S.P.S.T. . . . S.P.D.T. . . . D.P.S.T. . . . four point . . . S.P.D.T. (operates at clockwise position) and S.P.S.T. with Dummy Lug.

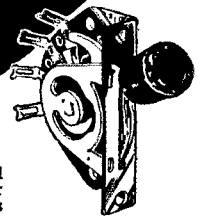

LEVER ACTION SWITCH

Used singly or in groups . . . for broadcasting, receiving, public address, test instruments and industrial uses. Available in any one of ten different combinations including positive and spring return action.

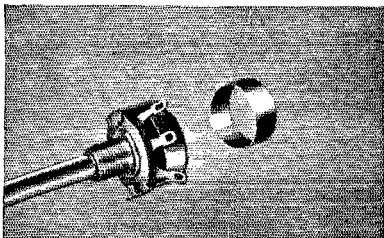

ELF RADIOHM

Smaller but also features the long, straight resistor strip. Available plain or tapped with S.P.S.T. switch . . . with or without dummy lug. Bakelite case 57/64" diameter, 17/32" deep (less switch) 25/32" deep with switch.

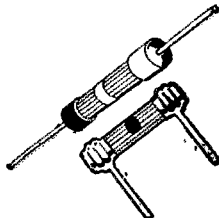

AXIAL LEAD RESISTORS

Body is insulated by inert ceramic jacket . . . proof against vibration and humidity . . . will withstand five times rated load without permanent change. In two sizes . . . RMA coded . . . 1/2 watt at 1/8" x 5/8" and 1 watt at 1/4" x 1" . . . Also supplied in conventional RADIAL LEAD Style . . . 1/2 watt - 1 watt or 2 watt.



CERAMIC TRIMMER CONDENSER

where greater stability than ordinary types is required. Supplied with neg. temp. coefficient of .006 MME/MME/C°. With or without mounting brackets.

CERAMIC CAPACITOR

Small "special purpose" for h.f. circuits where temperature compensation, low power factor, or absolute permanence are important. 1000 V.D.C. leakage resistance more than 10,000 meg. Power factor less than 1%.

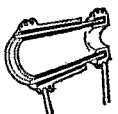

SEND FOR CATALOG NO. 23

★ ★ ★ ★ ★ ★ ★

NATIONAL DEFENSE NEEDS RADIO OPERATORS! PREPARE NOW!

★ ★ ★ ★ ★ ★ ★

SPECIALIZED training right in your own home will quickly prepare you for a promising career in the Army, Navy or commercial communications work. It is easy to learn **RADIO CODE** with the Candler System, the system selected by the ninth district U. S. Naval Reserve for training radio operators. The Candler System is a specialized training backed by over a quarter of a century of success in training radio telegraph operators. Why not start now! Find out today how easy it is to develop speed right in your own home.

**Get the FREE
Book Now!**

It tells you the inside facts of how you can train easily and quickly for an interesting career. It's FREE — Send for this book today — a postcard is all you need, and there's no obligation. Mail the postcard NOW!



CANDLER SYSTEM CO.

Box 928, Dept. Q-11 Denver, Colo., U.S.A.

★ ★ ★ ★ ★ ★ ★

**LEARN THE
WIRELESS
CODE
AT HOME**

INSTRUCTION BOOK FREE WITH EVERY SET

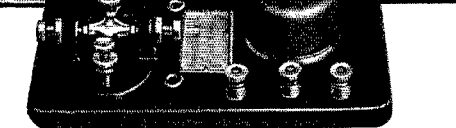

Make your spare moments count now! Learn the wireless code with a Signal wireless Practice Set. Set consists of key and high frequency buzzer mounted on a mahogany finished wood base equipped with binding posts. The code is printed on a plate fastened to the base between the key and buzzer. Adjustable buzzer. Price of instrument illustrated is \$3.40 list. If your jobber cannot supply you, order direct.

SIGNAL ELECTRIC MFG. CO.
MENOMINEE, MICHIGAN

*Established
1892*



milliammeter of special reversed design so that the normal no-current position of the pointer is at the right-hand end of the scale rather than the left. With the receiver turned on but no signal tuned in, the current flow is maximum and will force the needle to the extreme left of the scale. Any signal voltage applied to the receiver decreases the plate current and causes the needle to move toward the right. This reversed scale arrangement permits the S scale to be read normally, from left to right.

So far as is known these reversed-scale meters are not generally available to hams, and for home-built receivers or for installation in an existing receiver it is the common practice to use a standard low-range milliammeter connected in the plate circuit of a controlled i.f. tube. Its full-scale position will naturally be at the right, which becomes the S0 position. The S calibration will then progress to the left. Various circuit arrangements are possible, but a basic one suitable for most requirements is shown in Fig. 3. The meter sensitivity must be such that its full-scale current range is less than that drawn by the tube or tubes which receive their plate supply through it. Then by means of the variable shunt resistor the sensitivity of the meter is decreased until the maximum current flowing through it at no signal will just cause full-scale deflection. Thus this shunt constitutes the "zero adjustment" control.

If the meter employed is a sensitive one, such as 0-1 ma., it is usually connected in the plate circuit of only one tube as in Fig. 3-A. If a less sensitive meter such as 0-10 ma. is employed it will usually be necessary to feed two tubes through it, as shown in 3-B, to provide sufficient current to drive it to full scale and still allow some leeway for zero adjustment. In any event the tube in whose circuit it is placed must be of the remote cut-off type in order to spread the S calibration well out on the meter scale. The length of the leads to it is unimportant provided it is connected on the "B"-plus side of the usual resistance-capacity decoupling filter.

Fig. 4 shows a more complex arrangement (used in the Hallierafters SX-28) which, through the use of a separate meter amplifier, offers the advantage that the meter characteristics and scale can be adjusted over a fairly wide range and are not limited by dependence on a tube which has r.f. or i.f. amplification as its primary function. The diode section of the 6B8 serves as the detector and supplies the a.v.c. for one i.f. amplifier stage (a.v.c. for the balance of the receiver is supplied by a separate amplified a.v.c. system). The pentode section of the 6B8 serves solely as a meter amplifier, its grid actuated by the a.v.c. voltage developed in the detector diode. Adjustment of the screen and plate voltages provide for a relatively wide range of plate current/grid voltage characteristics and therefore the means for making the meter "scotch," flattering or average. The meter adjustment circuit differs slightly from those of Fig. 3 in that the shunt is fixed and a 500-ohm rheostat in series provides the means for zero adjustment by varying the effective sensitivity of the meter.

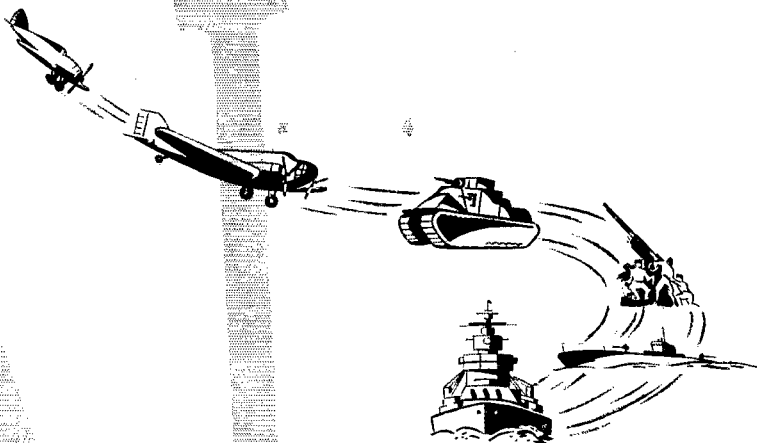

IRC RESISTORS HELP DEFEND DEMOCRACY ON ALL FRONTS!

From Reykjavik to Singapore, from Murmansk to Sidney, from Tobruk to Chungking; at sea, ashore and aloft; at home and abroad; IRC Resistors are doing their job. In airplanes and tanks, dreadnaughts and submarines, they have been thoroughly tested in the critical laboratory of actual "shooting" war. From the world's hottest and most humid climates, to the coldest and driest, they are standing the gaff of rigorous service in practically every type of equipment where resistors are required.

This widespread use of many types of IRC Resistors in modern defense equipment is a natural result of IRC's many years of specialization as well as its close collaboration with U. S., British and Canadian defense agencies.

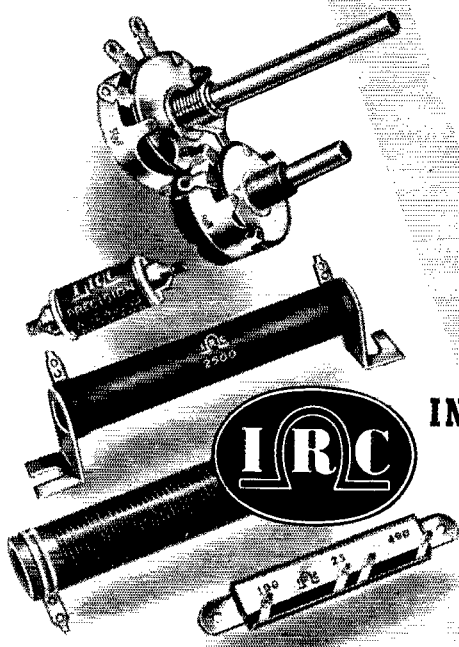

INTERNATIONAL RESISTANCE CO.

401 N. Broad St., Philadelphia, Pa.

Makers of Resistance Units of More Types, in More Shapes, for More Applications Than Any Other Manufacturer in the World.

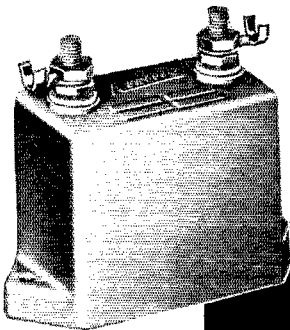

Selected mica and foil sections; vacuum impregnated; surrounded by low-loss filler for permanent protection against moisture. In porcelain-case and bakelite-case types.

Porcelain-case micas in 2000, 3500, 5000, 7000 and 12500 v. test ratings.

Standard capacities of .003 to .1 mfd. depending on voltage.

Bakelite-case micas in 500 to 6000 v. test. Widest range of capacities. Ask jobber to show you the listings.

Typical of the extensive Aerovox line of mica capacitors for every receiving and transmitting need.

Heavy-Duty MICAS

● As another tangible contribution to better "ham" radio, Aerovox offers you superior mica transmitting capacitors in both porcelain-case and bakelite-case types. The latter, until now made to order for commercial-equipment builders, are also available to you. ● Ask your jobber about these micas. Ask for latest catalog. Or write us direct.



Here's the instrument that's the best buy!

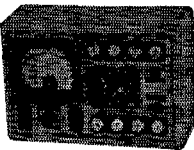

RCP 411 AC-DC Multi SUPERTESTER

- ★ You'll get 33 individual test instruments in 1 when you invest in this new RCP SUPERTESTER. That's a stand-out value for any man's money! Yet all you pay — well, look at the low RCP price, only \$19.45 — and the features:
- ★ 3-inch square meter with movement of 200 microamperes or 5000 ohms per volt ■ DC Volts 0/10/100/250/1000/5000 ■ DC Amps 0/1/10/25 ■ DC Milliamps 0/10/100 ■ DC Microamps 0-200 ■ AC Volts 0/10/100/250/1000/5000 ■ AC Amps 0/2.5/5/25 ■ AC Milliamps 0/500
- ★ Natural finish case, new design all bakelite body jacks. It speeds up service work. Net only . . . **\$19.45**
- ★ **HAMS! SEND FOR FREE CATALOG of latest RCP Test Instruments. Read about this complete line of all-quality test equipment. Discover how much you can save. Write for your FREE catalog copy TODAY.**



RADIO CITY

PRODUCTS COMPANY, INC.
88 PARK PLACE • NEW YORK, N. Y.

There are two ways in which the home-made meter arrangement can be calibrated. One is to tune around until a signal that the ear interprets as S9 is encountered and mark the pointer position with this value. This same process can be repeated for S8, S7, etc., or the scale between S0 and the S9 position can be simply marked off into 9 equal divisions and these marks labeled S2, S3, etc.

Another and usually more satisfactory plan is to set the receiver up side by side with one which does have an S meter. Switching the same antenna from one receiver to the other, signals of different strength are tuned in on the standard receiver and then on the receiver to be calibrated. The S readings indicated on the first are marked on the meter of the second. If the standard receiver is one for which the db. range of the scale is known (or is shown in Fig. 1) so much the better.

Steps have been taken at various times to establish some standard for S-meter calibration to be employed by all receiver manufacturers in order that the meter readings of different models will show greater uniformity. There are a number of design and production problems involved, but in spite of this some basis for agreement may be reached in the not too distant future. However, even if this were done immediately there would still be the great mass of existing communications receivers not in accord with this standard, and it is therefore hoped that, come what may in the future, the information presented in this article will be helpful to many.

In the Services

(Continued from page 55)

The 19th Signal Service Co. has the job of handling headquarters communications for the Seventh Corps Area, and its personnel includes Lt. Newhouse, 9NPI, Liaison Officer; M. Sgt. Rose, 9IHV, in charge of maintenance; Sgt. Morgan, 9BQP, chief op; Pvt. McCollum, 9WHS; Tabor, 9KUI; Stoll, 9YPA; Hicks, 5GPW; Yaeger, 9RVK; Christy, 9NJJ; and Kohlman, 9QLC.

RM2c Briggs, 9JZZ-2NUC, operates on the *Della*; RM3c Phelps, 2NZF, on the *Seminole*; RM3c Capellupo, 2JZQ, on the *Pocomoke*; RM3cs Kowrack, 8UFR, and Cobb, 6TWX, on the *Brooklyn*; RM3c Johnston, 9CBO, on the *Mawry*; Sigle Rollins, 6NQY, on the *S-39*. At the naval operating base in Newport, R. I., we find Krymityzky, 1BFS; Kellogg, 8PTP; Grace, 1EEP; Ross, 8UGJ; McArthur, 8MBA; Stangel, 2JZH; Stanton, 1JJX; Baldwin, 1IKE; 2GVW; and 1IYR. RM2c Henschcliffe, 1JBS, was assigned to the *Benson* after graduation from the Key West, Fla., sound school. RM3c Bacon, 4FZO, is a grad of the same school now attached to the inshore patrol base, Jacksonville, Fla. RM2c Vowles, 9BBL, is on active duty in the St. Louis communications center of the Coast Guard.

Sgt. Carroll, 3ILL, AACs op at Bolling Field, D. C., would like to get in touch with RM3c Hare, 1KCF, Noroton School grad. Ens. Scott,

GAS FILLED CONDENSERS

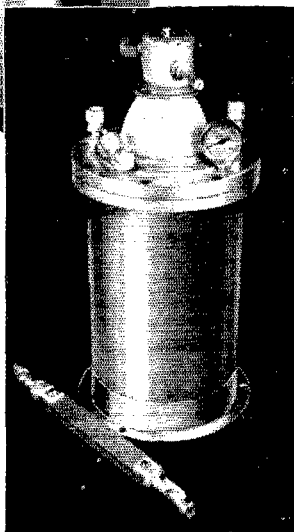
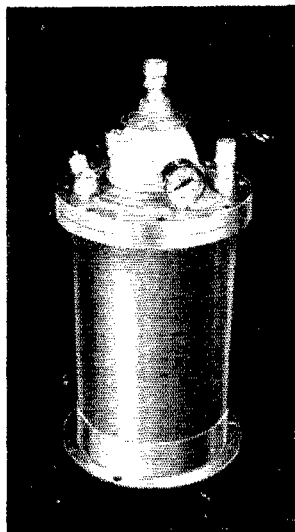
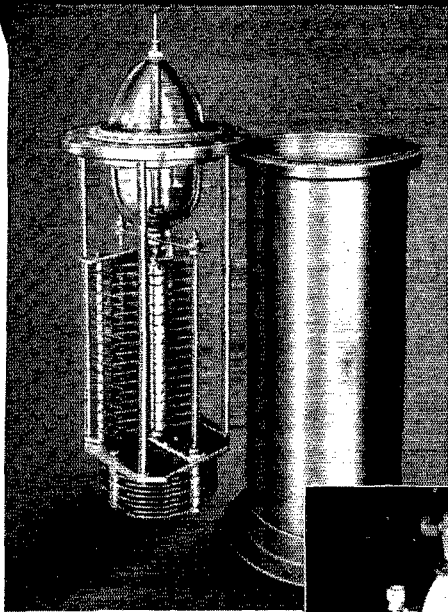

Efficient

DESIGN

Sturdy

CONSTRUCTION

Available in any capacity, and RMS voltage ratings of from 15,000 to 40,000. Can be furnished with fixed capacity, variable capacity, or a combination of fixed and variable sections. Other variations include gear housing for right angle drive and insulated shaft coupling.

Compact design and low price are features of Johnson Gas-Filled Condensers. Dry, oil-pumped nitrogen under pressures up to 350 pounds make possible closer spacing, greater capacity, and higher voltage rating. Gas tight joints prevent leakage over long periods of time. Designed for commercial application, these condensers are being widely used by broadcast stations and other high power transmitters.



E. F. JOHNSON CO

WASECA, MINNESOTA

EXPORT: 28 WARREN ST., NEW YORK, N. Y.

"MANUFACTURERS OF RADIO TRANSMITTING EQUIPMENT"

ASK FOR
NEW CATALOG
967-J

ANNOUNCING

A NEW MASTER TELEPLEX

To Teach You the Code

The Master Teleplex Code Teacher has been streamlined to make it easier for you to learn the code. Yes, the same engineers who developed the original Teleplex have worked out an entirely new principle. This new machine records your sending visibly by a brand new method on a specially prepared tape and also sends back your own key work at any speed you wish. Thus you learn by hearing as well as seeing. There are NO PERFORATIONS — NO INK. . . . A marvel of simplicity.

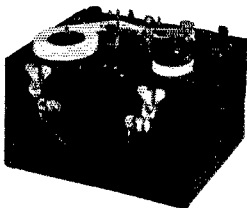

Teleplex machines are used by many schools teaching the code. Regardless of whether you wish to learn code as a hobby, a vocation, or to teach, you will surely want to see this new Master Teleplex. We furnish you a complete course, including practice messages, the new Master Teleplex plus a personal service on a money back guarantee. Low Cost. Easy terms. Special trial offer to any responsible defense unit. Write for complete information.

TELEPLEX COMPANY 107 Hudson Street
Dept. Q11
Jersey City, N. J.

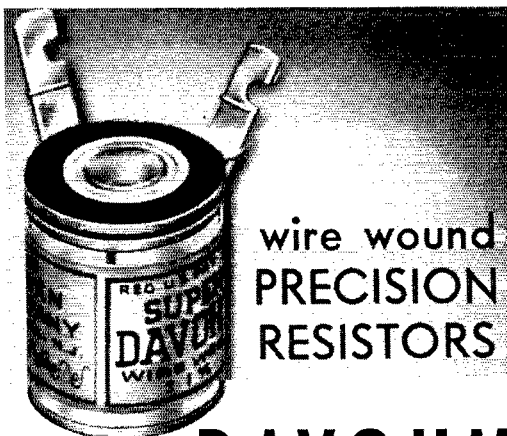

wire wound
**PRECISION
RESISTORS**

Super DAVOHM

Recommended for use in exacting equipment where accuracy, stability and dependability over long periods of time are of prime importance.

Accuracies from $\pm 1\%$
to $\pm 0.1\%$ available

PRICES AND LITERATURE UPON REQUEST

THE DAVEN COMPANY
158 SUMMIT STREET • NEWARK, N. J.

5ABE, has been called to active duty in New Orleans. Lt. Schoenwolf, ex-9AJN, has become communication officer of the Cavite, P. I., Navy Yard. Lt. (jg) Rose, 3SW, is on active duty at the Brooklyn Navy Yard. RM1c Kerr, 3CCC, operates at "Navy Radio Brooklyn," and Rigor, 3QL, at NAA in Cheltenham, Md. Ens. Harlow, 5CVO, is schooling at Bowdoin College, Me., in special communications work. RM3c Johnson, 4EKO, operates on the *Tuscaloosa*, and Alsobrook, 4FCC, on the *Ranger*.

Draftee Sventanovic, 8LWQ, was inducted at Ft. Benjamin Harrison, Ind. Sgt. Stavanja, 8LSX, and Velic, 8LZF, do signal work at Camp Shelby, Miss., with the Ohio National Guard. Lt. Hamlett, 4AKJ, has been called to active duty with the 99th C.A., Camp Davis, N. C. "Doc" Riheldaffer, SKKG, keeps the boys healthy at Ft. Oglethorpe, Ga. Sgt. Jamison, 2KWG, is in the cavalry squadron at West Point. Capt. Kale, 4HOE-3VE, is executive officer of the 112th F.A., Ft. Bragg, N. C. Sgt. Howe, 8LJD, does signal duty with the 174th Inf. at Ft. Dix, N. J. Dorothy Knapp, 2MIY, assists the AARS liaison officer in Washington. Sgt. Lardner, 2DBD, was called to active duty with the 156th F. A., Kingston, N. Y. Staff Sgt. Owsik, 2DYO, is communications chief of the 119th Obs. Sqdn., Newark, N. J., which includes Pvt. Gulick, 2ILS. Officer in charge of the 3rd Sig. Bn., Ft. Monmouth, is Lt. Simms, 2OEC. Lt. Huston, 3EHB, is 44th Division Comms. Officer, Ft. Dix, N. J. Also at Ft. Dix are Lt. Sheppard, 3HMY, Comms. Officer of the 157th F.A., and Sgt. Giles, 3DKB. Ed Raser, 3ZI, is doing research and development work at the Signal Corps Laboratories, Ft. Monmouth.

A Mobile Transmitter

(Continued from page 38)

and to a microphone plug (near the transmitter jack, J_3) at the other end. This lead is shielded wire, the shield being grounded at both ends of the line. The four leads, which run from the control box to the transmitter in the trunk, are encased in large-sized spaghetti tubing.

The power supply is housed in a metal cabinet both for good appearance and protection. Both of the cabinets (transmitter and supply) were bolted to the trunk floor before the rest of the equipment was installed. The transmitter and supply were then slipped in place and bonded together and to the car frame.

Antenna

The antenna is naturally an important feature of a mobile installation. In this case a half-wave vertical, end-fed with a tuned two-wire line, was selected because it is a good low-angle radiator and simple to install. The feeder length in our particular layout called for parallel tuning, and the tuner consisted of a 15- μ fd. midget receiving condenser connected across the swinging link. The condenser was mounted across the antenna insulator terminals on the outside of the cabinet. Recommended antenna lengths for different spots

A Ham Who Knows

Good Tubes— Bill Guimont, W9JID, W. A. S. on 160 Meters in 20 Hours with TAYLOR TUBES in his Rig.

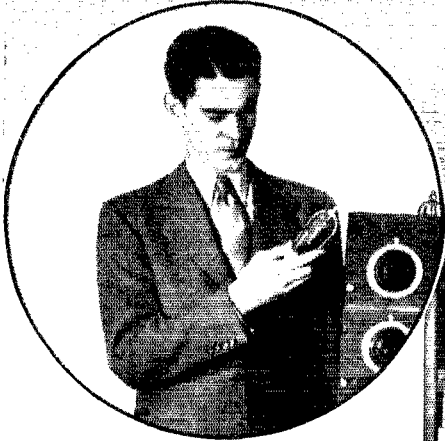

HISTORY REPEATS—

Once more, Taylor Tubes have played their part in another outstanding achievement. Whether it be a W. A. S. party or just plain every day contact work, discerning amateurs know that the dependability, high efficiency and greater safety factors of Taylor Tubes give their rigs the power and punch needed for good clear signals.

The *plus* features built into every Taylor Tube result in greatly increased *safety factors*, longer life and better all 'round performance. The Taylor margin of extra safety is backed up by Taylor's famous "More Watts Per Dollar" policy.

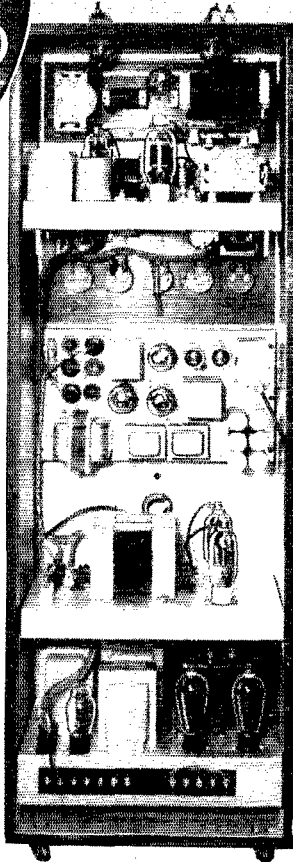

Proud of his record and proud of his rig, Bill Guimont, AMERICAN AIRLINES RADIO OPERATOR, knows the vital part that good tubes play in amateur communications. He knows too, that quality can't be sacrificed when there's a job to do. For dependability and top-notch performance, Bill has relied on Taylor Tubes for nearly 10 years. Again, "On the Air" proof of Taylor superiority has been confirmed.

STILL LEADING IN SALES

And for the new rig, Taylor's T40-TZ40 and 866 Jr. are a hard combination to beat.

"MORE WATTS PER DOLLAR"



Taylor HEAVY CUSTOM BUILT DUTY **Tubes**

TAYLOR TUBES, INC., 2341 WABANSIA AVE., CHICAGO, ILL.

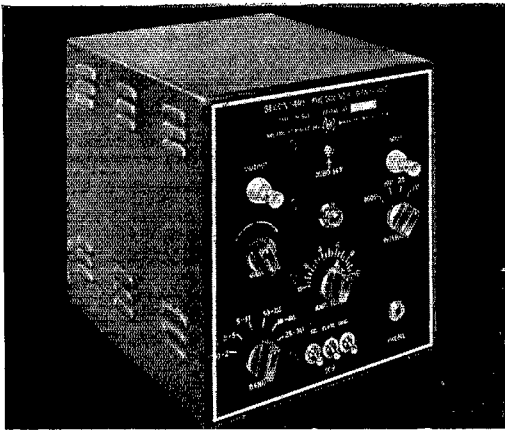

A Precision Crystal — Secondary FREQUENCY STANDARD

That Has Been "Designed for Application"

A precision frequency standard capable of being adjusted to WWV or some other primary standard and putting out uniformly accurate calibrating signals with 10, 25, 100, 1000 KC intervals. Uses the new GENERAL ELECTRIC No. 18A 1000 KC crystal having a frequency temperature coefficient of less than one cycle /Mc/C°. The crystal is sealed in Helium in a standard metal tube envelope. The self-contained AC power supply has VR150-30 voltage regulator tube.

In addition to oscillator, multivibrators, and harmonic amplifier, a built-in mixer with phone jack and gain control on panel is incorporated.

JAMES MILLEN
150 EXCHANGE ST.



MFG. CO. INC.
MALDEN, MASS.

Variety...

There's much to be said for the adage "Variety is the Spice of Life" . . . and there's much to be said for the great variety of Racks, Panels, Chassis and Cabinets in the Par-Metal Line. Variety gives you greater latitude in selecting just the right units for the job you build—whether it's a receiver, a transmitter, an amplifier or a complete Sound System.

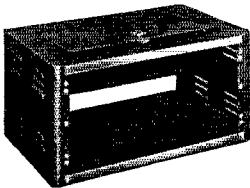

Chassis ★ Cabinets
Racks ★ Panels

In both Standard and De luxe models are listed in the Par-Metal Catalog No. 41. More than 400 items—all accurately machined for easy assembly. They're modern, streamlined, handsomely finished and with chrome hardware for enduring beauty!

PAR-METAL PRODUCTS CORP.

3262 49th St., Long Island City, N. Y.
Export Dept: 100 Varick St., New York, N. Y.

in the band, and tuning systems for various lengths of feeders, are given in *The Radio Amateur's Handbook*. However, the antenna length is not especially critical, and a 49- or 50-inch rod will work out nicely in most cases.

Adjustment

Plate currents can be measured by a 0-100 milliammeter fitted out with a plug for the plate jacks J_1 and J_2 . The oscillator plate current should be approximately 35 ma. with no antenna load and with 300 volts on the plate. The antenna coupling and tuning should be adjusted to obtain a full-load current of approximately 50 ma., using the loosest coupling which will give the desired plate current.

The modulator plate current should be about 25 ma. without speech and should rise to about 100 ma. on peaks. Under full modulation the plate current of the oscillator will kick downward slightly because of the voltage drop in the power supply when the modulator current increases.

Current and voltage readings will be low unless the power supply and transmitter filaments get the proper voltage. The slight drop caused by the long leads can be tolerated if the car battery voltage is up to standard, but a run-down battery may cause trouble. The voltage at the transmitter will be variable because the voltage at the battery terminals ranges from 6 to 8 volts, depending on whether or not the car motor is running. Sufficient voltage will reach the equipment if the car motor is turning over at a speed which shows "charge" on the dash ammeter.

With care in filtering out "hash"¹ as well as ordinary hum filtering, the hum should be at a satisfactorily low level when the gain control is set to give full output at normal speech intensity.

The preliminary testing might well be carried on with a dummy load coupled to the oscillator. As a matter of fact, this procedure is recommended unless the transmitter frequency has been set inside the 2½-meter band before the actual auto installation is started. In any event, check the frequency carefully before starting up for regular operation, because the antenna loading will affect the frequency. Also, because the circuit is high-C a small variation in the setting of C_1 will cause a considerable jump in frequency. It is wise to check the frequency each time an adjustment is made. Frequency checking devices are described in the *Handbook*; a useful set of Lecher wires is described in October *QST*.²

¹ Goodman, "Vibrator Power Supplies," elsewhere in this issue.

² "Lecher Wire System for U.H. Frequency Measurement," *QST*, October, 1941.



G8KV, 21 Brook St., Shrewsbury, Salop., extends a hearty invitation to visit him to all hams from this side who may go to England.

You can step up Efficiency with

OHMITE PARTS

THE high efficiency you get with Ohmite Parts can make a lot of difference in the performance of your rig. That's why it pays to use the 10 watt or 20 watt wire wound vitreous enameled Brown Devils, the 10 watt adjustable Dividohm resistors, the 2½ or 5 meter R. F. Plate Chokes shown here, and the many other well-known Ohmite units. They're all veterans of service in amateur, commercial and defense communications. Available, of course, in many sizes and values to meet your exact needs. *Get them at your Jobber!*

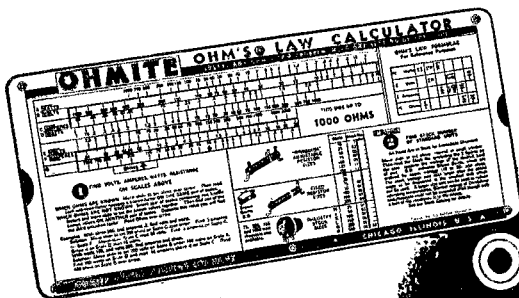
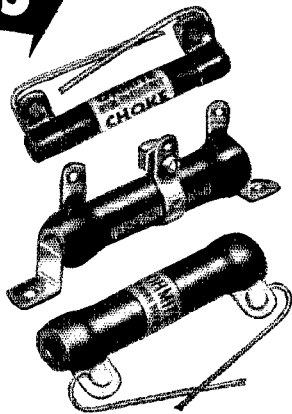

YOU can use
this handy new

OHMITE
Ohm's Law Calculator

ONLY 10¢ to cover
handling cost

Solves Any Ohm's Law Problem
with One Setting of the Slide

Figures amperes, watts, volts, ohms — quickly, easily. Does not require any slide rule knowledge. All values are direct reading. Scales on both sides cover the range of currents, resistances, wattages and voltages commonly used in radio and commercial work. Size only 4½" x 9". *At your Jobber, or Send the Coupon today!*

OHMITE MANUFACTURING COMPANY
4864 Flournoy Street, Chicago, U.S.A.
10¢ in coin enclosed. Send Ohm's Law Calculator

Name

Address

City State

QST—Nov. '41

Be Right with OHMITE
RHEOSTATS • RESISTORS • TAP SWITCHES

Station Activities



NEW ENGLAND DIVISION

CONNECTICUT — SCM, Frederick Ellis, Jr., W1CTI — The New Haven Amateur Radio Association, W1GB, celebrated the 15th anniversary of their affiliation with ARRL at Woodbridge Sept. 20th. Speakers were KDO, TD, LVQ, HRC and QV. Entertainment was supplied by two very capable magicians. Refreshments were served by FMV. About 60 hams enjoyed the hospitality of the NHARA which is one of the oldest affiliated clubs in the country. Officers are: KDO, pres.; KQY, vice-pres.; ATH, sec'y, and JQK, treas. BDI built a new heavy duty vibropack supply and added a 112-Mc. transceiver. KQY has Nutmeg Net under way for the Fall-Winter season and has been cooperating with the West Haven Defense Council. AEO, PAM, reports the 3.9-Mc. 'phone net meeting daily at 5:30 P.M. on 3950 kc. to handle traffic. The State Police Emergency Net on 112 Mc. meets Mondays at 7:30 P.M. ITZ has been appointed PAM for u.h.f. in New Haven and vicinity. Ben has been very interested in 112-Mc. work for some time and we are pleased to announce his appointment. MEG is working portable on 112 Mc. LRT has been getting out on 112 Mc., working into Brooklyn and New Jersey. KTF is active on 56 and 28 Mc. and is building a new house. NY1AA surprised the gang at CBA by paying them a visit. He was up from the Canal Zone on 30 days leave. It has been 7 years since Earl was home and all the gang were very happy to see him.

Traffic: W1AW 757 (WLMK 11) TD 60 LOP 33 BDI 31 KQY 30 B1H 19 NLM 17 KNV 12 KUK 7 CTI 4 GB-EAO 3. UE 70. (July-Aug.: W1EAO 6.)

MAINE — SCM, Ames R. Millett, W1BAV — New OPS: KKZ, LOA, MXT, NGV. The nets in this section are all going strong for the fall season. LYK has been doing a great deal to get the folks back home to keep in touch with the boys in the services. This is one of the finest things there is for the morale of the armed forces. NHI built a 70-foot mast rigged like a ship's mast and intends to raise it alone. NDV is planning a new rig with more power for 1.75 and 28-Mc. 'phone. KNJ is dividing his time between 1.75-Mc. 'phone and 7-Mc. c.w. KKZ visited LYW, KNJ, MNR and IGW on a recent trip to Auburn and had a swell time. MXT is putting up new poles and skywire for 1.75 Mc. LKP is on 1.75 and 4-Mc. 'phone and also working with the AARS and PTN on c.w. (The Northern Maine Net is going very nicely now with about fifteen stations reporting in nightly. They do need an outlet in Bangor. Why not get up on 1980 some night at 6:15 P.M. and get acquainted with the gang up there. FJP is confined to AARS operation at present due to inconvenience in shifting frequencies while being laid up. AUC still finds time to check into the Seagull net every night along with old faithful CMO and AL. IGW bought a new home. IIR recently visited MFJ and EZR. TO had 26 contacts in ZCB. DHD is going to give some time to c.w. this winter. IIE is still living at the camp and is planning to have his Thanksgiving dinner there. NGV has a new rig with 120 watts input. BAV had a swell visit from HFJ, BNS, who has recently moved to Waterville from Vermont, is an RM from St. Johnsbury and his appointment has been transferred into this section. Greetings, Merriek, from all the gang. The Androscoggin Amateur Radio Association has been issued the call NPP. AMR installed a new EO-1 cable in his antenna system. IJF has a new receiving antenna now. KOU entertained some of the gang at his annual October get-together this year.

Traffic: W1TO 19 KKZ 28 DHD 7 KNJ 17 MXT 13 LKP 19 AUC 6 CMO 19 NGV 12 LNI 1 LOA 11 BAV 40 AARS: W1AMR 50 VFO 46 FAP 118 GE 44 GHT 10 GVS 125 IJF 91 IST 56 IVV 60 KOU 201 LML 129.

EASTERN MASSACHUSETTS — SCM, Frank L. Baker, Jr., W1ALP — Most of the radio clubs have opened up for the season. Any visitors, new hams or old timers are invited to visit the club nearest them. If club secretaries will send me their meeting nights, I will include them in this column. Here is a list of a few clubs in the section: Lowell Radio Operators Club, meets 2nd and 4th Wed. nights; South Shore R.C., Quincy, 1st and 3rd Fri.; Eastern Mass. R.A., 1st and 3rd Wed. at N. U. Building on Huntington Ave., Boston; Framingham Radio Club; Brockton Radio

Club; HI-Q Club in Lynn; Parkway Radio Ass'n in West Roxbury; Waltham Radio Club; Merrimac Valley Club in Lawrence; T9 Club in Beverly; Mystic Valley Club in Malden; Norfolk County Radio Ass'n of Norwood; Fall River Radio Club. On Sept. 6th a meeting was held at WIGAG's with the following officials present: ALP, EHT, BDU, GAG, KTE, IIR, MQO, EKT, BXC. Your cooperation with any of these fellows is invited. New OPS: AR, JLK, ILR, GOU, JIS, HDJ, BKE. New ORS: NAV, MQT, GAG, EHT, IIR is new PAM for 14-Mc. 'phone. New EC's: IBF, Essex County; NEZ, Westford; CBY, Lawrence. LZW has a new jr. op and QTH. HSS is now in Ca. taking radio course. NPZ is new YL op in Weston. MKN has Class A. LAO now has XYL. NAH has new bug. NKE is new ham in Littleton. EVJ has new HQ120X and new skyhook on 3.5 Mc. JGQ and IBF attended Defense meeting in Lynn. NKW has MRT-3 on 112 Mc. MDN is working on emergency generator. KH is very busy in Wash., D. C., but gets home weekends and is on 56 Mc. OIB has new knotty pine shack. IVK says his brother MOO and MPJ, his wife, have a new 2nd harmonic, a boy. Congrats. He sure has a good start towards being a ham! LO says there's lots of fun on 112 Mc. with Mystic Valley Club having a treasure hunt every other Sunday. MQO has new remote control. MGQ has a new jr. YL op. Congrats. MYO and MJE are on 56 Mc. MZE is busy with new e.c.o. NF has new HY40Z class B mod. LB is on 56 Mc. CRW works 56 Mc. port-mobile. AAR is new CANOG for Corp Area 1.75-Mc. net. He recently worked 2GPO on 112 Mc. LGY is now in Fla. with Pan American Airways. HA has 500 watts on all bands. MJK is back from his trip and visited many hams. BAP is rebuilding. HIL is active on 1.75-Mc. 'phone. ZCC on 28-Mc. 'phone wants it known that he is not a bootlegger. MCR has new 112 Mc. rig. KTE has e.c.o. on 3.5 Mc. 'phone. IXI has 800 watt a.c. generator. EKT has new coaxial ant. KUD has portable on 56 Mc. CRW has his all band portable on 56 Mc. AYI has 112 Mc. mobile unit. NFQ putting up new 3 element beam for 28 Mc. Norfolk County Club is working out a program for emergency.

Traffic: W1AKS 258 (WLGO 82) JCK 211 (WLGV 17) AAR 128 JSM 126 LWH 98 (WJGF 139) BMO 92 BXC 93 BDU 70 KB 60 FSL 58 EMG 45 KZT 42 NAV 40 MQT 34 AAL 20 KTE 17 MKN 16 EHT 14 HA 11 MJK 10 GAG-BAP 3 AAL 20. AARS Nets: W1HIL 10 (July-Aug. W1HIL 15). North Shore 10 fone net: W1AGX 26 HWE 32 JFS 42 KMQ 5 LVZ 58 MQE 10. 2 1/2 meter net: W1EYR 142 MQH 80 LVI 41 MMY 73 MBS 54 MON 187 MIG 62 MIT 7 FIK 3 NBC 46 MPT 38 MTQ-MWN 32 MZJ 4. 80 CW net: W1AHP 38 FPE 191 (WLGs 24) FGT 28 KCT 127 MAN 10 TY 105. 160 meter phone net: W1KYN 4 MOJ 15 AR 4 WS 22 BWJ 60 FVL 24 IYU 65 MLZ 9 LGH 15 CCL 17 LSA 89.

WESTERN MASSACHUSETTS — SCM, William J. Barrett, W1JAH — IOR starts the season off with BPL. Nice going, Chet! MIM keeps busy with AARS. BIV has new 40-foot mast. Pres is also tackling the "mill" but says not to expect him to take the net on one yet. IHI opens with nice total. AZW blew plate transformer at peak of aurora display but guesses it happened independently. NKN comes through with first report of active season. JAH had visits from BVR, KZS, AZW and FOI. LUA is now New Haven RR Agent at Stockbridge, but will still live in Gt. Barrington. BVR has been working overtime trying to put three net frequencies where only one grew before. DCH spent vacation in Indiana. DUZ reports from Colorado, where he is vacationing. New members of AARS in West. Mass. include NJZ, NLL, BWY and LJQ. AJ qualified for OMRC. The active season is with us, so let's go, gang. How about putting first on our list some form of emergency power? Also, where feasible, some u.h.f. equipment for portable or portable-mobile operation. Then we will have any emergency situation well in hand. 73.

Traffic: W1IOR 250 (WLGJ 34) MIM 158 BIV 157 (WLGN 22) IHI 135 AZW 20 (WLGD 57) NKN 112 KZS 82 JAH 79 (WLGH 6) LUA 56 (WLCG 6) BVR 55 (WLGa 75) MND 25 HNE 41 MKR 39 MYZ-MBT 29 JWV-BXF 24 NLL-LHW 23 DCH 21 AJ 18 FNY 15 MVF 14 ADF-MJP 13 BWY 12 DUZ 9.

NEW HAMPSHIRE — SCM, Mrs. Dorothy W. Evans, W1FTJ — On Sept. 7th the Manchester Radio Club held an outing at the home of GDE. There were about forty members and friends present. During the afternoon games were played and in the evening an out-of-door fireplace provided hot dogs, hamburgers and all that goes with them.

GDE has a fine place to hold such an affair and many thanks go to him and to his XYL for their grand help in putting this outing over for the Club. BDN is changing her QTH but expects to be back on the air again more than ever during the early part of the winter. MLO has gone to school at Durham and we'll be hearing him on from there pretty soon. LSN is still active on 56 Mc. He is building a 112-Mc. transceiver for emergency tie 56 Mc. and says that the boys on Five have been following the progress of the new well being drilled atop Mt. Washington through almost nightly schedules with AP on the summit. JDP and his XYL, MWI, have moved over into Vermont and as soon as they can get settled up there expect to get back on the air to handle traffic for us through the N. H. Net. The Manchester Radio Club, LVK, voted to hold a meeting each Tuesday night. The second and fourth meetings in each month will be business meetings, and the first and third will be held for entertainment, etc. MXL boasts the arrival of a YL jr. up at his house. FB, Bill, and hope you make a brasspounder out of her! JKH advises of visits from 8VWQ, AVJ and AOQ recently. He also says the Laconia boys plan to get on 112 Mc. soon. KLV is new AEC member. NER is new ham at Manchester. The new net frequency of the New Hampshire Emergency Net on 1.75 Mc. is 1800 kc. By the time this report reaches you, the Net will undoubtedly be in operation on Tues., Thurs. and Sat. nights and on their present net frequency of 3840 kc. on Mon., Wed. and Fri. nights. IP will remain as NCS and it is sincerely hoped that all who can will join them at 6:30 P.M. on these frequencies.

Traffic: W1JKH 85 AOQ 22 IP 10.

RHODE ISLAND — SCM, Clayton C. Gordon, W1RRG — Officers of the RISG Amateur Radio Society are W1AFW, pres.; W1KVE, vice-pres. Members of W1AQ have become defense conscious with AMD, EJ and several others affiliating with the Local Police emergency movement. CH left for new job in Boston with WNAC. MEK was in ZCB contest and RM Nite. He reports PRA net is still kicking. PRA have a committee working on standardization for emergency equipment, specializing on 112-Mc. rigs at present. They have made considerable progress and are ready to confer with similar committees from other clubs in an effort to spread the idea to the rest of the State if possible. Westerly Radio Club has formulated plans for activities during the coming winter which include classes in code and theory for prospective hams, building of several vibrator supplies to be kept handy in case of emergency, etc. AGJ is in charge of communications in the recently organized Coast Guard Auxiliary. FOV announces the arrival of a new young op. Congrats, Pete. LYE's activities in the C.A.R. included a trip up 2000 ft. over North Smithfield to look over 112 Mc. JFF is heard up here in Warwick on 112 Mc. very FB.

Traffic: W1NED 14 MEK 3.

VERMONT — SCM, Clifton G. Parker, W1KJG — KOO returned from army duties and is now at 228 Elmwood Ave., Burlington. 3FNQ, JJCQ, MJE, KON and MMU visited AVP. AVP had recent tour of Navy Yard at Portsmouth and reports increase of traffic on 14 Mc. GAN and AVP are endeavoring to establish a 3.9 Mc. 'phone net for the Section. Details later. KUY and MJU are attending U.V.M. and have QTH at 22 Wilson st. Visitors at KJG were AEA, KUY, ND, IDM and KTB. KTB returned from army duties in the West and is on the air from his home in Lyndon. BVN is at Montpelier erecting the aviation radio beacon and was visited by NDL and NDB. KJG has been assigned WLGU for AARS work. KWB and NLO are installing rig in NLO's shack. KDB left for Erie, Pa., where he is with G.E. GAN is active on 3.9-Mc. 'phone with FB contacts. JVS moved to 116 No. Winooski Ave., Burlington. AEC registrations were received from LWN and KWB. Many inquiries have been received in regard to the AARS and ARRL nets in Vermont due to frequency changes as proposed. Under present prospects, these nets will continue to run on their previous frequencies of 3715 kc. and 3860 kc. until further notice. JRU has taken his rig to Portsmouth, N. H., where he is employed. CBW returned from summer camp and is again operating from home. AEA is on nets with T20 final, new antenna and a much improved signal. MZO reports some work on traffic commencing and progress on his portable rig. NLJ is busy building 250-watt transmitter. NAG has temporarily left Vermont and is attending Northeastern University. Emergency registrations are coming in steadily but slowly. It is hoped that every amateur in the Section, whether an ARRL member or not, will register promptly for the Self-Powered or Supporting Division. Our aim is to have a unit, large or small,

for each station which can operate on emergency power available, and receiving equipment of the same type. From 100 watts to 3 or 4 watts seems like a long jump, but this lower power will work our entire Section and neighboring states on 1.75 and 3.5 Mc. and the cost of a separate small unit or providing for use of a stage of the big rig on low power is small. Let's get together on this most vital phase of amateur activities under the present circumstances and "Put the Vermonters ahead!"

Traffic: W1AD 9 NDB 16 MMU 9 AVP 18 KJG 7 GAN 5 MZO 3.

HUDSON DIVISION

EASTERN NEW YORK — SCM, Robert E. Haight, W2LU — KWG is to be congratulated on the support he is giving E. N. Y. NCG is active on several bands in Yonkers. MEC is doing swell job for Test boys contacting their friends back home. KMH reports for the local boys of White Plains: ACD is still in circulation, by heck! KJR received Class A. HMO is back on 1.75-Mc. 'phone, and welcomes contacts. LFFJ is heard on 112 Mc. BWS operates 112-Mc. mobile. KMH and HMO visited MWS. KMH and AAD are active on 7 Mc. ILGW visited KMH. LRG got himself an XYL. Best wishes from the WP boys. KFB was in W4 for a month, is back on 7 Mc. with 40 watts to 807 final. LSD's new QTH is 61 Grant St., Yonkers, N. Y. Nils continues to do a swell job on Etherettes, and is to be commended on his efforts for ham radio. NAD and NOC joined the EC boys.

Traffic: W2KWG 75 NCG 35 MEC 6.

NEW YORK CITY AND LONG ISLAND — SCM, Ed. L. Baunach, W2AZV — W2CET is E.C. for Nassau County. IXZ is now located at 880 Third Avenue, N. Y. C. BO moved to 1127 Glenwood Road, Brooklyn. NZL is pounding brass aboard the SS *Cassimir*. KTF has been sent to the Capitol Radio School by the 8th Signal Co., and he says it is full of hams. AYJ is WLNQ in the AARS. FAQ just got settled in his new QTH at Tottenville, S. I. After working eleven years for the government, AV resigned and is now working for Sperry. BGO is back from vacation, and all stations in the Bronx should get in touch with him for traffic and emergency work. IXZ got up new antenna. MSS is spending all his time working on his big rig. AOT is a new member of the AEC. VG installed break-in, but is working to eliminate the clicks. BGV is on with rebuilt rig using 811 final pushed by band scooter with output on 3.5, 7 and 14 Mc. with 150 watts input. MZB's rig is now a 24A e.c.o.-6L6 bfr-p.p. 6L6's final with 50 watts input. LZB got a new Super Pro, and is going out for the ORS Party in a big way. JBL worked K6 with 25 watts input on 7034 kc. OCZ manages to get out on 3595 kc. with 3 watts input. OAF is a member of the 1.75-Mc. A.A.R.S. Net. BFS and his XYL, NJA, are looking for traffic on 7 Mc. IGO is on 1.75-Mc. 'phone. CY is a member of the basic AEC and is building Thordarson emergency transmitter. NDQ reports that there is plenty activity on 112 Mc., having worked N. Y., N. J., Conn. and Pa. with 30 watts input. RZ is Asst. EC on 112 Mc. in Nassau County, and reports good DX with low power. MWB flew to R. I. to meet W1MWK after a six-month schedule. The NNWA is attempting to organize a mobile unit for emergency operation with AYJ, AZS, INF and LZP. At a recent meeting of the Queens Radio Amateurs, the following officers were elected: LPJ, pres.; NDQ, vice-pres. and treas.; LGS, secy. The Section Net is still operating on 3710 kcs., but we soon have to change to another frequency. The new frequency will be entirely up to the operators, so all who have an idea where we should shift should let me know and the frequency selected by most will be chosen, but remember in picking consider time and QRM. BIV has been in the hospital for the past three months. AXZ enjoyed a seven-day furlough from SC. GIJ is operating at Naval Headquarters.

Traffic: W2SC 1394 (WLN 634) LZR 517 BO 466 DW 234 MRL 208 BGV 200 FJV 183 KL 163 JZX 94 AZV 75 DBQ 68 AYJ 55 MZR 50 NAZ 31 LK6 28 GP-MYI 27 LR 25 LYC 21 BWC 19 (WLNS 14) OAF 10 ADW 9 EC-FAQ 8 DOG 7 FF 6 BCS-CKU 5 AV-BGO 3 LBI-HGO 1.

NORTHERN NEW JERSEY — SCM, Edward Gursky, Jr., W2LMN — PAM, W2LXI — RMs: 2BZJ, CGG, HCO, IYQ — New appointments: RM, HCO; ORS, LFR. New faces in the Section include: 4GNQ and his XYL, 4HZP. They are both active from Atlantic Highlands. 4GNQ is ex-2ESO. Another newcomer is 2OAI who was

(Continued on page 98)

should old acquaintance be forgot?



Even under the pressure of National Defense work, we are making every effort to maintain our civilian contacts and to supply old friends whose patronage we have enjoyed through the years. Naturally the government comes first. Delivery dates to civilians are often long and uncertain. We are making a conscientious effort, however, to serve you and will give your inquiries the best attention within our means.

WARD LEONARD ELECTRIC COMPANY
41 South Street, Mount Vernon, N. Y.

WARD LEONARD

RELAYS · RESISTORS · RHEOSTATS

RADIO OPERATING QUESTIONS^A AND ANSWERS

Nilson & Hornung's new edition covers all FCC commercial license exam elements. Standard handbook 20 years. \$2.50, postpaid. Money back if not satisfied and book returned in 10 days. Send check or money order . . . not cash. *Free circular on request.*



NILSON RADIO SCHOOL, 51 East 42nd St., New York

Send 25 cents for the new 32-page 1942

RADIO CONTROL INSTRUCTION MANUAL

RADIO CONTROL HEADQUARTERS, INC.

330 West 42nd Street

New York City

JACOBS ADJUSTABLE SEPARATOR

U. S. patent No. 1,950,170 — March 6, 1934 — others pending



Using these Separators you can change the impedance of your open 2-wire R. F. feed line by split second adjustment ($1\frac{1}{4}''$ to $8''$) of the distance between the wires. Made of plastic. Light in weight; no tie wires; unbreakable. Price \$1.50 for a set of 6. CHARLES F. JACOBS (W2EM), 270 Lafayette St., New York, N. Y.

HARVEY ELECTRONIC

Manufacturers of
RADIO LAB'S, Inc. APPARATUS

447 CONCORD AVENUE, CAMBRIDGE, MASS.

A.R.R.L. AFFILIATED CLUB HONOR ROLL

The tabulation below was compiled from information contained in a questionnaire returned in response to a yearly club survey. The clubs listed are in addition to those included on page 70 of April, 1941 QST.

All members of these are A.R.R.L. Members

- Baton Rouge Amateur Radio Club, Baton Rouge, La.
- Charlotte Amateur Radio Club, Charlotte, N. C.
- Connecticut Brasspounders Association, Norwalk, Conn.
- Detroit Amateur Radio Association, Inc., Detroit, Mich.
- Glendale Amateur Radio Society, Glendale, Calif.
- Inter City Radio Club, Galion, Ohio
- Lake Worth Radio Club, Lake Worth, Fla.
- Mid-Hudson Amateur Radio Club, Poughkeepsie, N. Y.
- Mound City Radio Amateurs, St. Louis, Mo.
- Northeastern Indiana Radio Club, Kendallville, Ind.
- Parkway Radio Association, Roslindale, Mass.
- Pasadena Short Wave Club, Pasadena, Calif.
- Santa Clara County Amateur Radio Association, San Jose, Calif.
- Susquehanna Valley Amateur Radio Club, Selinsgrove, Pa.
- Valley Radio Club, Eugene, Oregon
- Worcester Radio Association, Worcester, Mass.
- Yakima Amateur Radio Club, Yakima, Wash.

WWV Schedules

IMMEDIATELY after the standard frequency station WWV of the National Bureau of Standards was destroyed by fire November 6th last, a temporary transmitter was established in another building and partial service was begun. The service has now been extended, although still with temporary equipment. It is on the air continuously at all times, day and night, and carries the standard musical pitch and other features. The radio frequency is 5 megacycles per second.

The standard musical pitch carried by the broadcast is the frequency 440 cycles per second, corresponding to *A* above middle *C*. In addition there is a pulse every second, heard as a faint tick each second when listening to the 440 cycles.

(Continued on page 94)

HOWARD

*Great Dollar for Dollar
Communication Receiver Value.*

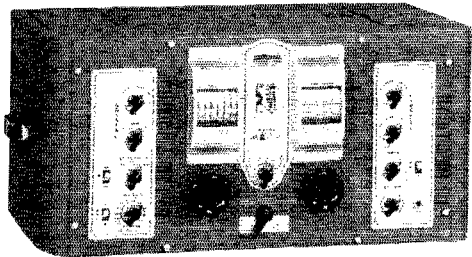

HOWARD "490"

The "490" 14 TUBES—5 BAND Professional RECEIVER

The finest professional type communication receiver built by Howard. Heavy duty construction throughout. Has two tuned R. F. stages, calibrated band spread, air-tuned I. F. transformers, variable I. F. selectivity, temperature compensated oscillator, split stator tuning condensers, variable audio fidelity, automatic noise limiter and 8 watts of push-pull audio. Provides super sharp tuning or broad fidelity for superb reception of music. The Howard "490" is the result of years of engineering and development—the specifications tell their own performance story. Model "490"—complete with crystal filter and tubes, **\$164.50**
less speaker.....

10" P. M. Howard-Jensen Speaker in separate matching cabinet.....**\$12.50**

ANNOUNCING THE NEW "445" — AC-DC RECEIVER — \$36.75

The efficiency of this completely new AC-DC receiver is truly remarkable and its performance is fully equal to that of any standard AC set of equal calibre. Six of the latest type tubes, with four of them doing dual purpose duty, provide complete circuit balance and exceptional stability. Model "445" is identical in

PROVIDES THE SAME FLAWLESS PERFORMANCE AS AN AC SET

looks and operating characteristics to the famous Howard Model "435-A", including the tuned R. F. stage and band spread on all 4 bands tuning from 43 MC to 550 KC continuously. An outstanding engineering triumph and value. Comes complete with tubes and built-in $6\frac{1}{2}$ " Howard-Jensen Electrodynamic Speaker.

(Export and Pacific Coast Prices Slightly Higher)

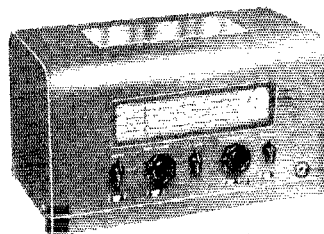

MODEL "435-A"

MODEL "435-A"—7 TUBES. Designed for amateur communications and for short wave reception from all over the world. Incorporates every desirable basic feature. Tuned R.F. stage on all four bands, with 3 gang condenser, provides improved selectivity, better signal to noise and image ratios and increased sensitivity. Has electrical band spread, BFO with pitch control, AVC, iron core L.F. transformers, A.F. gain control, headphone jack and $6\frac{1}{2}$ " Howard-Jensen Speaker. Has connection for battery operated Model 610 Power-Pack. Can be converted to a higher performance receiver with the Progressive Series Plan. Cabinet finished in gray wrinkle enamel. Price complete with tubes and built-in speaker..... **\$36.75**

With Carrier Level Meter **\$15.75 extra**

MODEL "436-A"—8 TUBES. All features of Model "435-A" above are included in this sensitive 8 tube communication receiver, PLUS an efficient automatic noise limiter and the famous Howard Inertia Tuning Controls. The noise limiter provides a wider range of noise-free reception. Howard Inertia Knobs achieve fast "fly-wheel" tuning when "looking over the band" or slow, smooth adjustment for weak signals. May be converted at any time to Model "437-A"—9 tube receiver. Price **\$41.75** complete with tubes and built-in Howard-Jensen Speaker.....

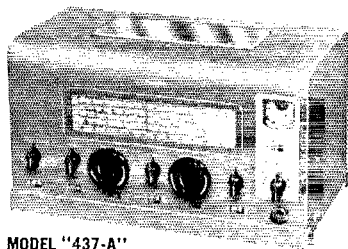

MODEL "437-A"

MODEL "437-A"—9 TUBES. Incorporates all of the features of Models "435-A" and "436-A", PLUS an additional stage of I.F. and Crystal Phasing Control to eliminate unwanted signals when crystal is installed. The most modern of engineering improvements provide an exceptionally high degree of sensitivity, selectivity and stability. In addition to the controls used on Models "435-A" and "436-A", the "437-A" has the Crystal Phasing Control, Crystal In-Out Switch and R.F. Gain Control. Copper plated welded steel cabinet, tuning range (540 KC to 43 MC) and basic construction is identical to Models "435-A" and "436-A". Model "437-A"—Complete **\$61.95** with tubes and built-in $6\frac{1}{2}$ " Howard-Jensen Electrodynamic Speaker....

With Crystal Filter installed.....**\$69.75**

With Carrier Level Meter as shown.....**\$15.75 extra**

**See Them at
Your Distributors!**

HOWARD RADIO COMPANY

1731-35 Belmont Ave., Chicago, Ill.
Cable Address: HOWARDCO, U.S.A.

Engineered and Built by America's Oldest Radio Manufacturer

(Continued from page 89)

formerly 3HKO. HXI is active again and expects to get most of his old schedules back. EKV is active on 112 Mc. FTP was badly injured in an auto accident a few months back and is now convalescing at Ft. Dix hospital. CIZ reports that great progress is being made at the East Orange Emergency Radio meetings. 3HVE is operating portable from Belleville. KSR is now active on both 3.5 Mc. and 7 Mc. A new radio club has been organized in Union City under the name "Beacon Radio Club." NCC replaced CNO as chief operator for the Garfield-Bergen Radio Assn. The club has 12 112-Mc. rigs in operation and about 15 more under construction. The Garfield Club recently played a ball game with a team representing the Clifton Radio Club. After a tough fight, the Clifton gang finally went down to defeat under the heavy hitting of the Garfield lads. After the game, a very good time was had by all (at the expense of the Cliftonians). A return game is promised for the near future. CNO is looking for traffic on 3780 kc. OCC, 1GRF/2 and 1HCU/2 have moved in with KNE and have been rebuilding the shack. They expect to be on the air shortly with a separate 100-watt rig for each band. LDZ has put a 112-Mc. rig in his car. CCU has been transferred to Maine. MZA, Freehold Radio Club station, is on with a 10P transmitter and Sky Buddy receiver. The boys have been fortunate in obtaining the services of Sgt. L. E. Hendrickson to conduct code and theory classes for those interested. Members of the AARS 'phone nets in this area recently met at the home of DAC and were treated to a fine program of talks and saw the War Department's film "Signal Corps Message Center." The Bloomfield Radio Club announces that code and theory classes are available to prospective amateurs. The club meets every Wednesday evening at 82 Broad St., Bloomfield. IZP has new HQ-120. Once again I'd like to remind the secretaries of all radio clubs in the Section that report on club or members activities will be greatly appreciated by the SCM for appearance in this column.

Traffic: W3JUU 245 MNT 206 (WLNW 24) CGG 140 MLW 131 KSR 125 NCV 114 LAMN 86 OA1 82 IYQ 75 (WLNW 34) LFR 63 MRJ 42 ANW 34 EKV 26 HCO 23 NJE 18 JKH 12 HXI 10 4GNQ/2 8 IZV 4 CIZ 1.

ATLANTIC DIVISION

EASTERN PENNSYLVANIA — SCM, Jerry Mathis, W3BES — FKO is now with FCC at Little Rock, Ark., and is signing W5KFX. 8EU is back on. 3HFE tested his battery-operated equipment at Ringing Rocks Park Sept. 7th. York Road Radio Club and PA-1 AARS net had fb picnic with 3HFE's portable rig along. 2M1Y/3 from Washington was present. 3FJU leads section this month with fine traffic total. 8OKC was punching away nicely in C.P. Frolic. 3AQN is handling traffic on 2043-kc. 'phone and is an active PAM. 3KJ announced arrival of second baby daughter. 3BXE has 809 back on and made 80,000 points in the ZCB contest. Among the younger set, JBC looks like he will make his way. FXZ enjoyed herself at the York Road Club's picnic. FLH is back on with a new NC101X. He received his 35 w.p.m. C.P. Certificate. ISN snagged his first W7, K5 and K6. DVC now has NC81X and boasts a 25 w.p.m. C.P. Certificate. EML swapped 809's for new 811's. 8ATF reported via radio. 3GDI puts in a little time in the contests. FJU received appointment as 'phone AARS radio aide which keeps his traffic rolling. DRO worked IEZ to discover he was an old buddy with whom he had lost contact for 25 years. It was a happy reunion of two old-time hams. 8UQM would like to hear more activity on 112-Mc. He intends to organize a 2½ meter emergency net as soon as necessary parts arrive at the NYA station. 8VYC. 3DGM and FLH made close to 30,000 points in the C.P. Contest. AGV is planning to extend his all band WAS conquest to 1.75 Mc. this winter.

Traffic: W3AOC 271 (WLMB 84) 8OKC 164 3AQN 113 3BXE 106 3JBC 65 3FXZ-3HCT 40 GDI 38 AKB 32 8UQM 24 3DGM 18 3FLH 17 8ATF 16 3AGV 15 3IXN 14 3EML 11 8OML-3DRO 8 3DVC 6 3HJE 4 3GKK-3BES 2 3FJU 688 3KJ 2.

MARYLAND-DELAWARE-DISTRICT OF COLUMBIA — SCM, Hermann E. Hobbs, W3CIZ — Eppa W. Darne, W3BWT, Chief RM. Roy Corderman Regional Coördinator, W3ZD. The Delmarva Club boys report much activity on 1.75 Mc. 'phone. Dot now has a ten watt 'phone rig hooked up in her kitchen. Does that have anything to do with a pi-coupler? 3CDQ recently visited the Mexican

Amateur League station, XE1CB, and was made honorary member. DRD now has 400 watts to 54's pp. IBM is now located at Sydney College near Farmville, Va. He sends his regards to all and will be pleased to have any of his friends call on him there. The mail address is Box 367, Hampden, Va. HAE is also there and brought along his HRO and 150 watt rig. FQK is also attending the same college. JAS reports nice traffic total and is on AARS daily. JFW is on 7-Mc. band e.o.o. JHW sold his SX-16 and is getting NC-200. JKO has schedule with Puerto Rico on 7 Mc. Pete, JSH, shows a growing traffic total, is active in Md. AARS net and has signed up for cryptography course. 2MXI would appreciate a traffic schedule between 3 and 4 p.m. for the boys from Troy, N. Y., located in the Army Camps, etc., located in this vicinity. 3HUM reports TL A-P ready for business and lined up from East Coast to the Pacific. PV has Class A now and is taking AARS Net correspondence course.

Traffic: W3BZK 112 BWT 883 CIZ 148 DRD 70 EQK 1 FE 14 FFN 21 JAS 87 JFW 40 JHW 7 JSH 19 HUM 27 PV 66 USA 2000 (WLM 3140).

SOUTHERN NEW JERSEY — SCM, Lester H. Allen, W3CCO — Ass't SCM and AARS Liaison RM, ZI Regional Coördinator in charge of Emergency Coördination, BAQ, RM's: BEI, BYR, ITU. PAM, EUH. Section Net Frequencies: OPS 1980 kc. (Thurs., 8 p.m.); ORS 3700 kc. (Tues., Thurs. and Sat., 8 p.m.). The ORS and OPS nets are going through the overhaul stage which means that the inactive fellows will be dropped from the ranks. A few of the Section leaders will be changed due to pressure of business or moving from the section. If you haven't joined one of the section nets as yet, why not send in your application as we can always use a few more members, particularly in the isolated spots of the Section. If you can't join, why not let me hear about a friend who may be interested. 3IOW. K5 is contemplating getting on 28 Mc. from Fort Sherman. GEV is rebuilding his beam for 28 Mc. AYC is rebuilding and expects to have 700 watts for 28 Mc. BWF started on a 3-element rotary for 28 Mc. EUH reports progress on his rebuilding. EED has rig working on 28 Mc. ITU recently worked 112 Mc. from his car during a trip to Boston. HKO moved to Rumson and is now 20AC. BYR is working at Fort Monmouth. GRW is chief operator aboard the SS Vacuum. GCU is trying to finish his WAS; Ray needs only three more states. AQ needs only four more states to complete WAS on 1.75-Mc. 'phone. ZI, our Ass't SCM, is candidate for Director of the Atlantic Division. GCU will be his running mate for Alternate Director. IZT has rig all set for 7-Mc. 'phone. Several inquiries have been made concerning DGE, DAE and CNS. If anyone knows of their activities, please notify the SCM. IMY renewed OPS for another year. GHR is to be complimented for the technical article in Sept. QST. HFX reports Somerset Hills Radio Club held their annual hamfest Sept. 23rd and everyone had a swell time. HYT reports for the first time and is doing a nice traffic job. BDL is busy on 112 Mc. CWG rebuilt his radio room and now has a complete soundproof shack. HAZ holds daily schedules with 1MUV. JBU is trying to increase his copying speed. ZI has schedules via AARS to all USA and possessions. ABS reports his new kw. rig is working FB from 1.75 to 56 Mc. AVJ is doing a swell job of traffic handling in ORS and AARS nets. JAV is new OPS. JKY is working portable at NYA camp No. 6 at Greenbank. DAJ received his QSL from Little America. Doc also recently changed his qth. GPU is rebuilding modulator for his 14-Mc. rig. GFL is now located in Maple Shade. LT is on 1.75-Mc. 'phone from Trenton. JNB is a new AEC member. GZS is latest OPS in the Section. JND is new call in Trenton. ABS reports fair results in the last UHF Marathon. The DVRA will hold its 10th Anniversary celebration and banquet on Nov. 8, 1941, the affair will be limited to 125 persons, so if you haven't made reservations as yet and want to attend, better get busy. 73.

Traffic: W3BZX 150 ZI 141 EWK 122 OQ 100 AVJ 98 HKO 74 AQ 76 HAZ 68 ITU 53 GNY 51 CCO 50 HYT 31 BEI 24 GCU 19 CWG-JBU 12 GHR 5 ABS 1 WLNW 39.

WESTERN NEW JERSEY — SCM, Fred Chichester, W3PLA — The big event of the month in the section was the army ZCB contest. Quite a few of the locals turned out for it. OAO is working 'phone on 3917 kc. DII is rebuilding to about 250 watts. SZB will take traffic for Pine Camp. WIF, a new ham in Rochester, is working 7- and 14-Mc. c.w., already has K4, K5, K6 and KD4 contacts to his credit. BHK is working 14-Mc. 'phone. WGC is new ham in Avoca. An SWL in Alexandria Bay, reports having heard

KB6GJX on 3.5 Mc. GHU is back on 1.75 operating fixed portable at Sacketts Harbor. RCJ is on 56 Mc. VUG is a newcomer on 3.5 Mc. LLZ is on 1.75 Mc. 3HPB/8 is at Pine Camp. TEP is in Lowell again. 2NMK/8 left WSLB and is now on the engineering staff at WWNY, Watertown. VLM has a fb rig on 1.75-Mc. 'phone. DHB is still operating fixed portable from his camp on the St. Lawrence River. ETE, who has a position at the St. Lawrence State Hospital, heard one of the patients talking dits and dahs. Upon questioning it was found that he was a former telegrapher! QLV is pounding brass on 3.5 and 7 Mc. again and expects to handle some traffic this winter. QJL is taking up radio in the Navy. Ray Lafferty, chief engineer at WSLB, has a new ham ticket with the call VTJ. OZN is on defense work at Elmira. SHP is now in Buffalo. FLX, of Niagara Falls, is on all bands. He was 2JBQ in Albany for the past 6 years. RMR is rewinding a 12-volt generator to 110 volts for emergency use. WNY ORS have been tentatively assigned 1780 and 3560 kc. for net use as soon as the Army takes over the portion of the 3.5-Mc. band in which they now operate. CSE is listening for c.w. stations on 1.75 Mc. OQU is communications air chief in Kansas City. ELK is still drilling oil wells and working 1.75-Mc. 'phone. TEX is on the road and is heard only on week ends. TJJ has new QTH with plenty of antenna space. RKO is back on the air after a lapse of some time. RDX moved back to Rochester from New York. RV5's receiver blew up and he is awaiting delivery of new NC200.

Traffic: W8AIE 25 BAL 28 BJO 112 BOA 19 CSE 53 DII 228 DSS 40 EUY 6 GPM 13 JIW 141 KBW 16 KYR 290 KXR 25 MLM 21 MVB 28 MXC 87 PLA 463 RGH 185 RKM 187 RTX 116 SBV 60 SFD 42 SMH 99 SXR 37 SZB 2 TDB 61 TUS 24 TVO 17 VFG 41 VQZ 28 USX 27.

WESTERN PENNSYLVANIA — SCM, E. A. Krall, W8CKO — Asst. SCM in charge of ORS activities, KWA. Asst. SCM in charge of AEC, AVY. RM's: NCJ, TOJ and KUN. NCJ is trying for WPR certificate. PER is going to start his OBS sessions at 9:30 P.M. on 3575 kc. Mondays through Fridays. TTD seldom misses an ORS session. VYU has new antenna now and is AARS member. WQ still manages to handle some traffic. RBI, one of our PAM's comes across with a nice report for 'phone. UUZ is an excellent contact at Uniontown and is ready for any traffic in that direction. BWP says W4FWV/8 is now 8WIQ and that WJF operates on 14 Mc. BOZ inactive this summer although he reports a 56-Mc. mobile rig well under way. TWI is operating YA at State College. KXR has been operating 3.9-Mc. 'phone. We wish to remind all 'phone operators that traffic can be handled on 'phone as well as c.w. Dr. Carl F. Oerlein, SHW/SUS, of State Teachers College informs us that beginner's code practice lessons will be transmitted from there. TOJ is pleased that the summer net sessions have worked out so well. The W. Pa. ORS net will meet daily at 6:30 P.M. except Saturday and Sunday on 3750 kc. When a change of frequency becomes necessary due to FCC orders, the net will shift to 3590 kc. One of the RM's will guard the net frequency after the close of the net each evening until 8 P.M. TOJ submits the following report of activities for the period of Aug. 16th to Sept. 15th: Number of net sessions, 21; number of stations reporting, 160; number of stations per net session, 7.61; number of messages handled during net, 265; number of messages per session, 12.5. This report shows an increase of 44 per cent over the messages handled during previous period, while the number of stations reporting remains approximately the same. Liaison between the ARRL and AARS nets is satisfactory and some of our ORS are also AARS. CKO is liaison between the two nets for traffic purposes and invites comments and suggestions regarding any improvements. Your SCM appeals to each ORS to stimulate activities and to invite more station owners to apply for appointment.

Traffic: W8KWA 380 TOJ 333 CKO 271 NCJ 177 TWI 141 PER 98 TTD 60 VYU 56 WQ 20 RBI 17 RAT 11 UUZ 9 BWP 2.

DELTA DIVISION

ARKANSAS — SCM, John R. Sanders, W5GNV — Asst. SCM, 5GED. As this report goes in the R.I. has just completed his regular bi-annual examination schedule at Little Rock. The Commission anticipated an increase in applicants due to the growing need for operators, and extended the schedule one day. Some two hundred examinations were conducted. An opportunity was afforded to see some out of town faces we had not seen for some time. Among those present were W4ASK, W5ILT, GCW, DNX,

CPV, GG, BM and many others. We hope all of these boys find themselves up another notch in the game as a result of their efforts. Several of the fellows have expressed a desire to handle traffic this season and have asked advice on the best procedure to follow. We are attempting to form some Section traffic nets on 1.75-Mc. 'phone and c.w. Anyone interested please contact the SCM. We have several very good possibilities for outlets if a net can be formed. Traffic sources have increased also, especially with Arkansas' 153rd Infantry now in Alaska. Considerable traffic to and from there is already being handled. Inquiries concerning Official Appointments are increasing and several new appointments have been made. A card to the SCM will bring the information on any appointment that interests you. JIC has turned in a complete list of AEC members lined up in his area and says there are more coming. FB, Marshall. Keep up the good work. IUE has new rig with 807 final. The Ft. Smith R.C. conducted two hidden transmitter hunts in September and has others scheduled. KJV is new call in Ft. Smith. JYU is "mowing 'em down" on 3.5 Mc. EA is still pounding out traffic in AARS. ANR reports the AARS Fall Picnic was held at Hot Springs August 31st and everybody had a swell time. BMI was guest and plans to rejoin the net. FWD has really had company this summer, 6PIB, 5DLR, 5HQC and 4HGC all with XYLS. KEC and KFM are new calls at Eldorado. KIM is moving to Eudora. HLW is getting back in the swing on 1.75 Mc. DGU is handling AARS traffic in and out of Little Rock. BJR is getting the feel of his new receiver for fall activities. KEG is new station with a nice rig on at the NYA school at Camden. IDQ is using larger rig with a couple hundred watts and sounds F.B. BM is taking on duties as a "Cop Op" on the new police setup at Monticello. GGW is building a new rig from "stem to stern!" JHL overcame difficulties by changing transformers and is now going again. EQP has rig set up in Little Rock now with 1/2 kw. on 14-Mc. 'phone. DNS writes that he will have to give up his W5 call for a W9 now that he is with CAA in Mo. HYS, GWT and KDP registered in AEC. ENH is on consistently now, picking his bands at random. FXO is settled in Little Rock and is heard regularly on 1.75 Mc. W8FKO/5 has been transferred from the Little Rock Monitoring Station back up east to Pittsburgh. Good luck, Carl. IYW is new OPS. GWT is conducting code lessons under sponsorship of Ft. Smith Club. BRW attended the Dallas convention, flying his own plane down. IXH visited in Ft. Smith while on leave from the Navy. CVO is now with the Navy at the school in Brunswick, Maine. GNV has up new skywires and is now active at night. Give me a shout, fellows. The Little Rock Club, as is its usual custom, threw a gabfest and picnic for DU, the R.I., on his trip through in September.

Traffic: W5DNX 427 FWD 376 ANR 315 BJR 34 ICS 32 EA 26 DHU 13.

LOUISIANA — SCM, W. J. Wilkinson, Jr., W5DWW — KHH is new in Monroe. CNG has plenty trainee traffic. HEJ handles traffic also. JET is on 7 Mc. early mornings. DXL is back after long lay off. PJW worked 1.75-Mc. 'phone. IDK is active again. JMK, HUY and JEY have noon rag chews on 1.75 Mc. with FJW. HFI is now in Army and hopes to be on soon with low power. JBI is rebuilding for 'phone. HQY is handling traffic. IUZ and HCV are working c.w. schedules on 1.75 Mc. DRF is proud grandpappy and will soon begin teaching new op code. INN is doing good work in St. Joseph. IVF is back on 7 Mc. after vacation. K6QXY, W6PB and their XYLS were visitors in Monroe. DWW is trying to get back on 3.5 Mc. BPL was QRL with storm warnings at request of N.O. Weather Bureau. IWY is on 7162 in Burrwood. BSR made BPL. JNY is rebuilding. ex-K4GZR is now stationed in N.O. BUK is now in the Navy. GXI is with Signal Corps at Ft. Monmouth, N. J. IMY and HQY are active in AARS. HR keeps 14-Mc. schedules. HSH is rebuilding. KHC, KKI and KJE are new in Shreveport. QH is new president. CARC. ex-K6GOES is now located at Barksdale Field. HUZ works 1.75 Mc. with traffic. The OVARC voted to buy \$400 worth of defense bonds. Several members of this club were guests of Monroe Lions Club and gave amateur radio demonstration and lecture. Emergency nets were set up and ready during recent storm threat but the storm failed to materialize. Most stations in maneuvers areas have been flooded with selectee traffic.

Traffic: W5HEK 348 CNG 925 HEJ 324 AKJ 37 JET 20 DXL 8 FJW 5 IDK 4 BPL 11 IWY 15 KC 26 EGC 20 HNW 326 ACY 449 BSR 149 CEW 201 HSH 111 JKW 14 QH 1 HUZ 50 HHV 121 IYL 18.

STANDARDIZE ON THE STANCOR DC 3 TRANSMITTER FOR EMERGENCY OR PORTABLE APPLICATIONS



SPECIFICATIONS

- Type of Emission..... A3
- Output Circuit..... Variable Loading Coil
- Antenna Requirement..... Single Wire
- Power Output Available... 8 Watts
- Frequency Range..... 1.95-6.9 mcs.
- Type of Frequency Control. Quartz Plate
- Power Source..... 6 or 12 volt Storage Battery
- Power Consumption..... 45 Watts
- Cabinet Dimensions..... 6" High x 6" Wide x 6 1/2" Deep
- Weight..... 11 lbs. in Cabinet with Crystal and Tubes

★ ★ ★

The DC 3 is an extremely compact, light weight, radio-
phone transmitter, affording emission where the source
of power is DC, as encountered in aircraft, marine,
portable and emergency applications. Although the
displacement of the unit is slightly over 1/8 cubic foot,
every detail from the vibrator power supply to the vari-
able antenna loading system is self-contained.

Two crystal controlled channels between 1.95 and
6.9 mcs. are readily selectable by a panel switch.
"Press-to-talk" operation is used to facilitate com-
munications.

The DC 3 kit includes all parts, cabinet, shock absorb-
ing mountings, 8' battery cable, and two vibrators
(one for spare).

NET KIT PRICE **\$31.50**
(less accessories).....

Price subject to change without notice

ASK FOR DESCRIPTIVE BULLETIN No. 230

STANCOR
STANDARD
TRANSFORMER
CORPORATION
1500 NORTH HALSTED STREET . . . CHICAGO

WWV Schedules

(Continued from page 90)

The pulse lasts 0.005 second, and provides an accurate time interval for purposes of physical measurements.

The 440-cycle tone is interrupted every five minutes for one minute in order to give the station announcement and to provide an interval for the checking of radio measurements based on the standard radio frequency. The announcement is the call letters (WWV) in telegraphic code.

The accuracy of the 5-megacycle frequency, and of the 440-cycle standard pitch as transmitted, is better than a part in 10,000,000. The time interval marked by the pulse every second is accurate to 0.000,01 second. The 1-minute, 4-minute, and 5-minute intervals marked by the beginning and ending of the announcement periods are accurate to a part in 10,000,000. The beginnings of the announcement periods are so synchronized with the basic time service of the U. S. Naval Observatory that they mark accurately the hour and the successive 5-minute periods; this adjustment does not have the extreme accuracy of the time intervals, but is within a small fraction of a second.

On the Ultra Highs

(Continued from page 48)

And now we have a new 400-Mc. record. In tests conducted in the Mojave Desert, W6MYJ operated from the foothills while W6IOJ drove out in the desert, making tests every half hour. Contact was made at 30, 40, and 60 miles. Though the terrain was smooth, it was found that both stations had to be in elevated locations for contacts at any distance. The 60-mile contact was made when W6IOJ was at an altitude of 4000 feet. At this point, signals were very strong, with even the receivers being audible across the path! Rigs used were identical 955 transceivers, at about 2 watts input. W6IOJ also has a pair of 955 rigs working on 800 Mc. Tests have been made by installing one in W6MYJ's tower and listening as far as it could be heard. A copper reflector has been used for the receiver and a "square corner" beam on the transmitter. Though the efficiency is naturally very low at this frequency the transmitter has been heard at a distance of three miles. A B-K oscillator is planned to increase power so that some long-haul tests can be made.

Texas Hurricane

(Continued from page 39)

"Traffic was handled for the Highway Department, State Police, Red Cross, Weather Bureau, and Texas Defense Guard. The Guard did great work in helping with the evacuation of some three thousand troops from Camp Hulon to surrounding towns. Since the time when the wires were out was the middle of the night, little personal traffic was handled, but we had the set-up ready for that when necessary. Fortunately, the emergency was of short duration, but plenty of damage was done during that period!

"Too much cannot be said of the cooperation shown by the hams. Virtually every station in the state was standing by to help if needed. During the period I contacted 53 stations, and had schedules every 15 minutes with stations in important strategic locations. Although I do not have full information on their activities, I under-

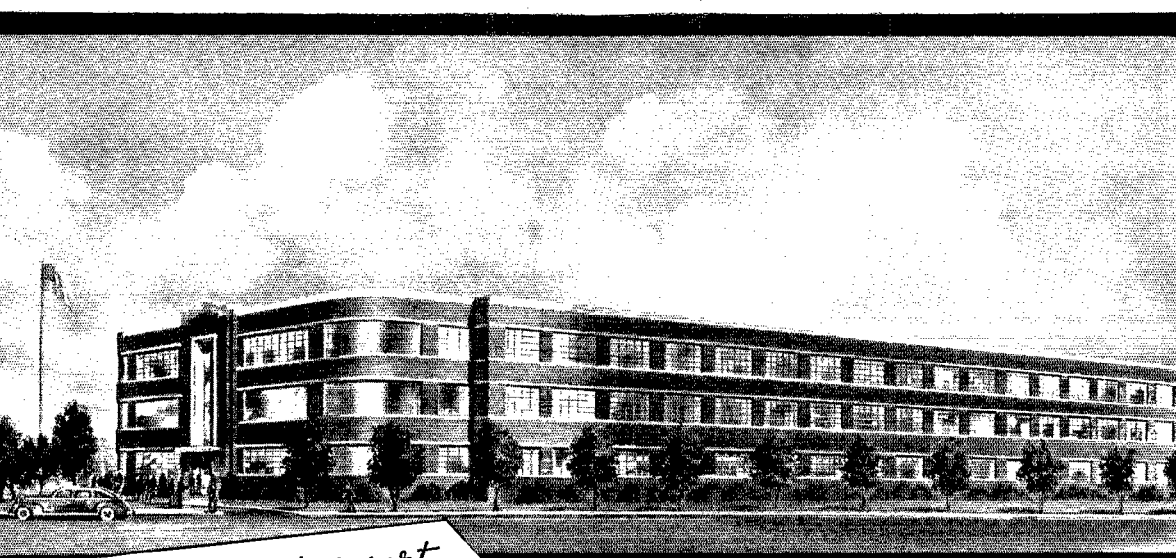

We are happy to report
PROGRESS

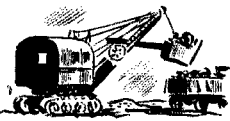

ALSiMAG has been made in the largest, best equipped teatite insulator plant in this country. Declining Government financial aid, this plant is now being expanded to provide a 300% increase in capacity. Careful plans of more than a year swiftly bear fruit. As walls go up, they are literally built around the newest and most modern equipment. Trained men take charge. The pace of production whirls steadily upward, 24 hours a day—7 days a week. This new plant is of glass block, brick and reinforced concrete. Large areas of it are air conditioned, all of it has the complete dust controls essential to highest quality manufacture. Wherever possible, automatic control units are a part of all equipment.

Defense requirements have the right of way in this plant. Neither you, nor we, would have it otherwise. Daily we come nearer our goal of being able to supply defense requirements and also make our usual prompt deliveries on expanded civilian requirements.

The cornerstone of this organization is a policy of continued improvement through research and development. The Engineering and Production Staffs of American Lava Corporation contain representatives of many of the leading technological institutions of this country. Thus it is only natural that four completely equipped new laboratories sweep across one floor of this new building. These four laboratories, electrical, chemical, mechanical and testing, are in charge of men whose skill is favorably known to leading engineers in this country and abroad. These men and these laboratories are our pledge of continued leadership in technical ceramics.

This advertisement is one of a series designed to give you a better understanding of the advantages of ALSiMag insulation. It is not a solicitation of business. Custom made ALSiMag is sold direct to the manufacturers.

39th Year of Ceramic Leadership

ALSiMAG

Trade Mark Reg. U. S. Pat. Off.

FROM CERAMIC HEADQUARTERS

AMERICAN LAVA CORPORATION • CHATTANOOGA • TENNESSEE
CHICAGO • CLEVELAND • NEW YORK • ST. LOUIS • LOS ANGELES • SAN FRANCISCO • BOSTON • PHILADELPHIA • WASHINGTON, D. C.



**2½ Meter ABBOTT TR-4
TRANSMITTER and RECEIVER
in a single compact unit**



Designed specifically for governmental, commercial and advanced amateur applications, the ABBOTT TR-4 incorporates the latest advanced design refinements. Less power supply and tubes, net price.. **\$39.00**

CAMERA!

Our Camera Department is doing a whale of a "trade" with radio amateurs. We swap camera equipment for radio gear, and radio for camera. Let's get together.

W2IYL • W2LJA • W2PL • W2KWY

OUR *Best* VALUE IS OUR RECORD OF LOYAL SERVICE

HARVEY
Radio Company of New York

103 WEST 43rd STREET • NEW YORK, N. Y.

CABLE ADDRESS: "HARADIO"

stand that there were quite a few stations on 7 Mc. along the coast that did good work until 7 Mc. began skipping. (Unfortunately 7 Mc. is generally not usable for work within the state after 5-7 p.m. these days.) W5CVQ and W5ZG are known to have been active on this band.

"The Adjutant General of the State of Texas was standing by and listening to all work done from a NC200 receiver placed in his office in the capitol building. Gen. J. Watt Page is also head of the Texas Defense Guard, and was in personal contact through our net with the work being done by the guard in the emergency. A great deal of good-will was created for the hams through this radio network operation. All officials of the guard and of the State Legislature here in Austin are overflowing with praise for the hams. We have been handling considerable traffic recently for the Governor of the State, also."

Organization and preparedness — those are the needed things. The 45 member-stations of the TDG/AARS net and the other amateurs of Texas demonstrated that they were both well-organized and fully prepared. FB, OM's!

— C. B. D.

Vibrator Power Supplies

(Continued from page 46)

quires much more than this to run should be considered doubtful. A vibrator that requires 5.5 volts or more is definitely "bad." If the vibrator is connected to a constant load, the output voltage should not vary over any appreciable range, and if it fluctuates more than 5% one should start looking for trouble. If the supply is homemade and doesn't give rated voltage at the desired current drain, it doesn't necessarily mean that the vibrator is no good but it probably indicates excessive drop in the battery lead or through either the r.f. chokes or the filter choke. However, fluctuating output voltage is a good indication of a poor vibrator unit or a poor connection, probably at the battery terminals. Vibrator manufacturers recommend that the specified value of the buffer condenser never be changed in a manufactured pack, that no attempt be made to repair a vibrator by filing contacts or bending the springs because they have both been adjusted at the factory, and that a vibrator never be replaced until one is sure that the vibrator is the defective component.

There are two factors affecting the choice of self-rectified or tube-rectified vibrator power supplies. If the circuit used is one where the filter choke can be connected in the positive lead and where the negative can be returned to one side of the tube heaters, the self-rectified vibrator supply is the logical choice, although the tube type can be used. However, if bias for some tube or tubes is obtained through a drop in the negative lead, thereby eliminating the possibility of returning the negative lead to ground, the tube rectifier type must be used.

The regulation of an average vibrator power supply runs a little less than 25% from rated full load to no load with a constant input voltage of

And now . . . The NEW ABBOTT TR-4 Ultra High Frequency 2½ meter TRANSMITTER-RECEIVER



The new ABBOTT TR-4 was especially designed to fill the needs of governmental and commercial services as well as advanced radio amateurs for an extremely compact, powerful, single unit incorporating a separate transmitter and receiver.

Only advanced and tested engineering principles and design refinements are incorporated in this new ABBOTT TR-4. Write for details or see them at your local jobber. List price, less tubes and power supply (subject to amateur discount) **\$65.00**



MRT-3

High power (20 watts input), 2½ meter Transceiver for automobile, truck, boat or airplane. Simple to install and operate, with a satisfactory operating range of from 5 to 50 miles.

Less tubes and power supply. . . . List **\$49.00**

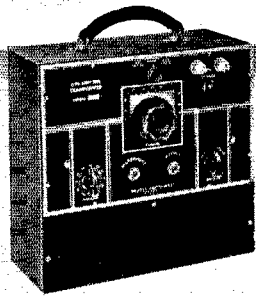

DK-3

Unusually low priced, portable, 2½ meter Transceiver with special Variable Antenna Coupling. Incorporates only 2 inexpensive tubes. Effective range is from 2 to 30 miles.

Less batteries and tubes. . . . List **\$32.00**

ABBOTT INSTRUMENT, INC.

8 WEST 18 STREET • NEW YORK, N. Y.

AMATEUR



COMMERCIAL

TYPE PR-X IN
"ALSMAG" HOLDER
40-80-160 M. BAND
ONLY \$3.00

WRITE US
FOR PRICES

Fast Service

PETERSEN RADIO CO., Council Bluffs, Iowa

SICKLES COILS

ALL TYPES OF RF AND IF WINDINGS

Manufactured by

F. W. SICKLES COMPANY

P. O. Box 920

Springfield, Mass.

EASY TO LEARN CODE

It is easy and pleasant to learn or increase speed the modern way — with an **Instructograph Code Teacher**. Excellent for the beginner or advanced student. A quick and practical method. Available tapes from beginner's alphabet to typical messages on all subjects. Speed range 5 to 40 WPM. Always ready, no QRM, beats having someone send to you.

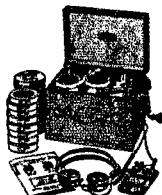

MACHINES FOR RENT OR SALE

The **Instructograph Code Teacher** literally takes the place of an operator-instructor and enables anyone to learn and master code without further assistance. Thousands have used and endorse the **Instructograph System**. Write today for full particulars and convenient payment and rental plans.

INSTRUCTOGRAPH COMPANY

4709 Sheridan Road, Chicago, Illinois

Representative for Canada:

Radio College of Canada, 54 Bloor St. West, Toronto

ANSWERS By

TRIPLET



THE need for uniform quality in parts has been answered by Triplett's manufacturing facilities, which make the company practically self-sustaining in the fabrication of instrument and tester components. Here is one section of the Triplett automatic screw machine department where essential parts are turned out 24 hours a day. Triplett has turned to wholly automatic fabrication of materials to speed production and eliminate human error. To assure Triplett quality, company engineers have pioneered in the design and manufacture of countless fabricated materials including switches, bar knobs, resistors, jacks, special adapters, etc.—a complete service intended to give each user the fullest measure of satisfaction.

THE TRIPLETT ELECTRICAL INSTRUMENT CO.
Bluffton, Ohio

Hams, Defense School Students and Gov't Men



Ayers Automatic Code Machines
Dept. Q-10, 711 Beakton Street, Boston, Mass.

are learning the code the right way, quickly and easily with the all electric Ayers machine. Built by Code champion McElroy for our future champions. Largest selection of tapes in World available with each machine. Low monthly rental. Tapes for MacAutos, recording slip and special inks for sale.

AMATEUR RADIO LICENSES

Day and Evening Classes in Code and Theory

HOME STUDY COURSES

Reasonable, Efficient and Thorough, Hundreds of Licensed Students Now on the Air

American Radio Institute, 1123 Broadway, New York, N. Y.

COMMERCIAL RADIO INSTITUTE

A radio training center for over twenty years. Well equipped. Excellent faculty. Practical resident courses in Radiotelegraphy, Broadcast, Servicing, Television, Aeronautical, Drafting, Mathematics, Industrial and Studio Technique. Placement bureau. Fall term Oct. 6. Send for catalog. Dept. B.

38 WEST BIDDLE STREET, BALTIMORE, MARYLAND

RADIO TECHNOLOGY



RCA Institutes offer an intensive course of high standard embracing all phases of Radio and Television. Practical training with modern equipment at New York and Chicago Schools. Also specialized courses in Aviation Communications, Radio Servicing and Commercial Operating.

Illustrated Catalog on request.

RCA INSTITUTES, INC. Dept. ST-41

A Radio Corporation of America Service

75 Varick St., New York 1154 Merchandise Mart, Chicago

6.3 volts. The regulation becomes something worse than this if the input voltage varies appreciably over the no-load/full-load range. As a result it is well not to skimp on the voltage ratings of by-pass and filter condensers that are used. On the other hand, it is common sense to allow for plenty of safety factor in any portable or emergency rig, and the regulation of a vibrator supply is no good argument against its use as long as one designs his equipment for a supply of this type.

It is not good practice to overload a vibrator supply. They are designed to work over a wide range of battery voltages (5.5 to 8.0 volts) because the charging generator will boost the battery voltage considerably while the car is running, but the power drain on the output of the supply should never exceed more than 8% or 10% of the rated output with 6.3-volt input. Heavy overloads will cause rapid wear and sometimes sticking of the contacts, and this latter will usually result in a burned-out vibrator unit unless proper fusing of the unit is provided.

The light weight and good over-all efficiency (from 65% to 75%) of the vibrator power supply makes it well worth considering by any amateur interested in a compact emergency or mobile power supply. Table I lists some of the vibrator power supplies that are available and, although the list is not as complete as that shown in the 1942 *Handbook*, it will serve to show what can be had in this type of supply. It should be unnecessary to stress again the importance of preparation for the future by as many amateurs as can afford it. When Maj. General J. O. Mauborgne says, as he did in the September *QST*, "U.h.f. portable or movable self-powered apparatus will be of extreme value in the future, and every amateur possessing such apparatus in working order will be mighty glad he has it," any amateur who is on his toes doesn't have to be hit over the head a few times to get the idea.

I.A.R.U. News

(Continued from page 50)

operating in the black, thanks to the cooperation of its members. Its *Ham Chatter* appears regularly, the latest issue carrying a list of nearly one hundred ZS amateurs on active service. Amateurs have also sponsored and furnished instructors for a signal training school to provide radio operator and technician personnel for the air forces.

QSL CARDS

There are a few QSL cards on hand at Hq. for the following stations, at one time located on Pacific Islands. If anyone knows the present whereabouts of the operator of any station listed, ARRL Hq. would appreciate the dope on a post-card.

KC6LDB, CKM, BVL; KD6OU, QHX; KD4HHS, GYM, OPJ; KE6QAC; KF6DHW, OWR; KH6KKR.

NOTES

"CQ PK," official organ of our Netherlands Indies friends, appears in de luxe style for

HIGHLY EFFICIENT • MODERATELY PRICED

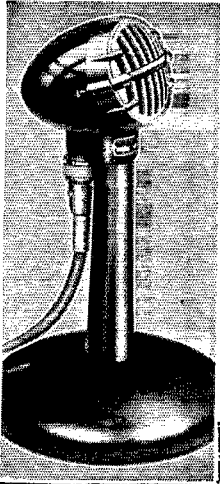

**JT-Series
Microphone**
List Price
\$15.50

See your Astatic Radio Parts
Jobber or write for catalog

**N-Series
Microphone**
List Price
\$17.50

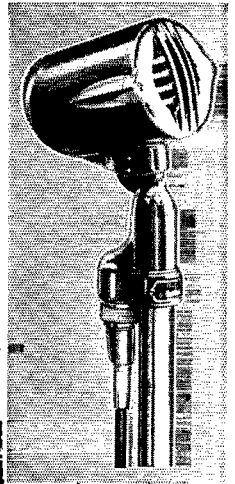

ASTATIC

THE ASTATIC CORPORATION

YOUNGSTOWN, OHIO

Licensed Under Brush
Development Co. Patents

In Canada:
Canadian Astatic Ltd.
Toronto, Ontario

Be a MASTER Radioman

Get your training at home under personal supervision of A. R. Nilson, noted technical radio author. Low-cost home-study radio communication courses can fit you for job, advancement, or license examinations. Send for *Free* booklet, "What The Modern Radioman Must Know."

NILSON RADIO SCHOOL, 51 East 42nd St., New York

RADIO COURSES

Start November

**RADIO OPERATING • BROADCASTING • CODE
RADIO SERVICING • TELEVISION**
• **ELECTRONICS** — 1 year day course; 2 years eve.
Day and Evening Classes — *Booklet upon request*

NEW YORK YMCA SCHOOLS
4 West 63rd Street, New York City

LEARN RADIO • TELEVISION

60-page catalog on request. Oldest, largest and best equipped in New England. New classes now forming. Write for new catalog.

MASS. RADIO SCHOOL

18 Boylston Street

Boston, Massachusetts

RADIO

ENGINEERING, broadcasting, aviation and police radio, servicing, marine radio telegraphy and telephony, Morse telegraphy and railway accounting taught thoroughly. 48 weeks' engineering course, equivalent to three years of college radio work. School established 1874. All expenses low. Catalog free.

THE DODGE INSTITUTE, Day Street, Valparaiso, Indiana

★ Performance ★ Accuracy ★ Value

Ranges to 1200 volts D.C. • 2400 volts A.C.
• 5 Megs • 600 MA and + 62 DB

All in **PRECISION**
Series 832-A
31 range AC-DC
compact circuit tester

Condensed Specifications

★ 6 D.C. voltage ranges to 1200 volts ★ 6 A.C. voltage ranges to 2400 volts ★ 4 D.C. current ranges to 600 MA ★ 3 Resistance ranges to 5 MEGS ★ 6 Decibel ranges to +62 DB ★ 6 Output ranges to 2400 volts ★ Easy reading 3" bakelite cased, wide faced 800 microampere meter ★ Each instrument individually calibrated to within 2% D.C. and 3% A.C. overall accuracy ★ Overall size only 7 x 4½ x 3 inches.

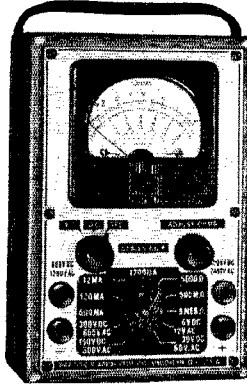

Tops in multi-tester value at only **\$16.95 net**

Write for the new radio amateur, laboratory, industrial test equipment catalog No. 42-Q . . . just off the press

PRECISION TEST EQUIPMENT
Standard of Accuracy SEE THEM AT YOUR JOBBER

PRECISION APPARATUS COMPANY

647 Kent Avenue

Brooklyn, New York

Export Div.: 458 Broadway, New York, U. S. A. — Cables: Morhanex

G.H.Q. FOR EVERYTHING IN RADIO

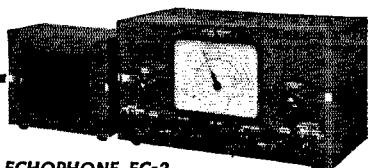

ECHOPHONE EC-3

MAKE Terminal your General Headquarters for radio parts and equipment. Here's an outfit that meets even the most exacting requirements. Efficient service, quality merchandise, complete stock and friendly dealings with our customers are our stock and trade.

ECHOPHONE

- EC-1, 6 tubes, AC-DC, complete. \$24.50
- EC-2, 8 tubes, AC-DC, complete. 42.50
- EC-3, 10 tubes, crystal and speaker. 59.50
- EC-4, Echophone portable. 49.50

HALLICRAFTERS

- S-19R, 6 tubes, built-in speaker. 32.50
- S-20R, 9 tubes, rf stage, speaker. 54.50
- S-22R, Skyrider Marine, complete. 74.50
- SX-24, Crystal filter, less speaker. 74.50
- SX-25, 12 tubes, crystal filter. 94.50
- S-27, AM/FM u.h.f., less speaker. 195.00
- SX-28, 15 tubes, crystal filter. 179.50
- SX-32, 13 tubes, crystal filter. 149.50
- S-29, a real portable for all bands. 69.50

HAMMARLUND

- HQ-120-X, tubes, crystal and speaker. 168.00
- SUPER-PRO, 18 tubes, "the last word". 318.00

NATIONAL

- NC-200, with tubes, less speaker. 159.50
- NC-45, with speaker and tubes. 57.50

Ask us for catalogs and technical data describing these outstanding values in communications receivers.

NEW ABBOTT

**2 1/2-meter transmitter-receiver
Model TR-4**

Amateur Net Price
(less accessories) **\$38.22**

In Stock for Immediate Delivery

Send us your mail orders — we'll fill 'em!

TERMINAL Radio Corp.

68 West 45th St. • 80 Cortlandt St.
2 stores in NEW YORK CITY
Vanderbilt 6-5050 • Cable: TERMRADIO

its tenth anniversary. . . . SUICH was the Cairo reporter in recent CBS broadcasts to the Americas from foreign capitals. . . . N.V.I.R. is doing a commendable job among Netherlands hams; of particular note is a technical course now appearing in "CQ NVIR." . . . On December 16, 1940, Esthonian amateurs were finally closed down and transmitting equipment sealed. . . . We acknowledge official greetings from the North Manchester Radio and Television Society, England, and send our best wishes for a speedy return to normal operation. . . . We regret having to report the deaths of Cunha E. Costa, CT1SP, president of the Portuguese Society, and Don Angel Radaelli, LU2CA, prominent in affairs of the Brazilian league. . . . W.I.A.'s *Amateur Radio*, now in mimeograph format, carries a list of over 100 VK amateurs now serving with the country's defense forces. . . . A. B. Gillin, "Eastcourt," Goozee St., Randwick, Sydney, Australia, is seeking a pen friend among American amateurs.

Sweepstakes Rules

(Continued from page 49)

logs. Club members must send in full reports either direct or through the secretary to substantiate any club's claim on the gavel award!

Report Results

Report to ARRL, West Hartford, Conn., as soon as the contest is over. Use the log form shown in the example. List all operators whose work at your station is responsible for any part of the score.

All active ham operators are invited to take part and report. You will work a new bunch of stations, make new records for your station, get QSL cards (be sure to send one for each QSO), have a lot of fun, meet new friends, and perhaps rate an ARRL award at the conclusion. Do your best operating. Send ARRL the results for QST mention. **MAIL YOUR REPORT IMMEDIATELY AT THE END OF THE CONTEST TO AVOID DELAY AND ENSURE THAT YOUR RESULTS ARE CREDITED AND KNOWN THROUGH QST.**

New Apparatus

NEW INEXPENSIVE THERMAL RELAYS

IN THE design of emergency communication equipment, a type of apparatus which is of growing importance in connection with the activities of local civilian defense organizations, it is common practice to include provision for operation from both self-contained batteries and light lines. With such an arrangement, the battery power need be used only when operating in the field where line supply is not available. In the home shack, emergency headquarters, etc., the line supply is used to conserve batteries.

An interesting development for use in this type of equipment is a newly-introduced relay tube which automatically changes the equipment over for line operation when its cord is plugged into a light line. More than this, it allows the equipment to go into immediate operation from

AGAIN
IT'S

KENYON

PRESENTING A BRAND NEW
PLATE TRANSFORMER DESIGNED
FOR THE NEW *R.C.A. 931*

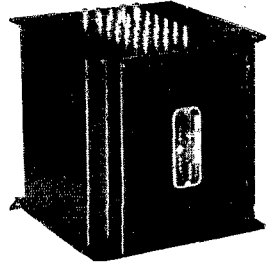

● Again Kenyon leads the way with a Plate Transformer built right around the new R. C. A. 931, Electron Multiplier Tube. Housed in the famous T Line Case built to Kenyon's rigid standard of manufacture. Specifications are as follows:—

Type T-211 ■ Primary: 0/105/115/125 volts 60 cycles ■ Secondary No. 1:—
0/100/200/300/400/500/600/700/800/900/1000 volts at 10 MA. R.M.S. ■
Secondary No. 2:— 2.5 volts at 1.75 amperes ■ Case Size: 4A ■ List Price: \$9.50

Kenyon Transformers available thru your nearest distributor or write direct. COMPLETE CATALOG FREE UPON REQUEST.



KENYON TRANSFORMER CO., Inc.
840 BARRY STREET NEW YORK, N. Y.

OFFICES IN PRINCIPAL CITIES

Cleveland 3292 Cedarbrook Rd.
Chicago 21 E. Van Buren St.
Kansas City, Mo. 2004 Grand Ave.

Seattle 2605 Second Ave.
Los Angeles 2412 7th St., W.
Dallas P. O. Box 4116, Sta. A

New Orleans 618 Girod St.
Lutz Florida
Richmond, Va. 3105 Edgewood Ave.

Up to the Minute THE LICENSE MANUAL

is always kept up to the minute. When you read this a new edition incorporating all of the recent changes will be off the presses and on sale. We insert correction sheets whenever there is a change in the amateur regulations which cannot be incorporated in the printing of the LICENSE MANUAL. To keep abreast of amateur regulations, have a copy of the up-to-date LICENSE MANUAL in your shack at all times.

25c postpaid (no stamps please)

The American Radio Relay League, Inc.
West Hartford, Connecticut

RADIOMEN ARE IN DEMAND

Ever since the inception of Midland Airline training, the demand for our qualified graduates and students has exceeded the supply. Now because of the acute shortage of skilled radio operators and maintenance men, the demand has reached a new high.

REAL OPPORTUNITY — Midland training offers you exceptional opportunity to put your hobby to work. Steady, well-paid positions in the Air Transport and Broadcast Industries await the man with required qualifications.

INVESTIGATE NOW — Investigate Midland training now! Write or wire for a free copy of our profusely illustrated 58-page booklet and training outline. No obligation. Liberal terms. Combination Extension-Resident training or straight Resident training. Refresher courses for men with commercial licenses.

**MIDLAND RADIO
AND
TELEVISION SCHOOLS, Inc.**
Dept. Q-11, Power & Light Bldg., Kansas City, Mo.

NOW—a really high-powered
RADIO
ENGINEERING
LIBRARY

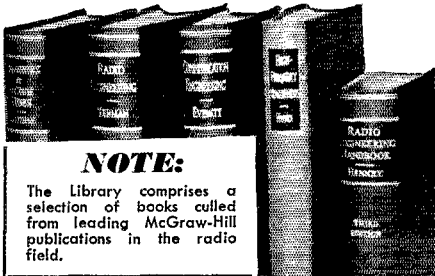

NOTE:

The library comprises a selection of books culled from leading McGraw-Hill publications in the radio field.

- ➔ especially selected by radio specialists of McGraw-Hill publications
- ➔ to give most complete, dependable coverage of facts needed by all whose fields are grounded on radio fundamentals
- ➔ available at a special price and terms

THESE books cover circuit phenomena, tube theory, networks, measurements, and other subjects—give specialized treatments of all fields of practical design and application. They are books of recognized position in the literature—books you will refer to and be referred to often. If you are a practical designer, researcher or engineer in any field based on radio, you want these books for the help they give in hundreds of problems throughout the whole field of radio engineering.

5 volumes, 3559 pages, 2558 illustrations

- Eastman's **FUNDAMENTALS OF VACUUM TUBES**, 2nd edition
- Terman's **RADIO ENGINEERING**, 2nd edition
- Everitt's **COMMUNICATION ENGINEERING**, 2nd edition
- Hund's **HIGH FREQUENCY MEASUREMENTS**
- Henney's **RADIO ENGINEERING HANDBOOK**, 3rd edition

10 DAYS' FREE EXAMINATION

SPECIAL LOW PRICE

EASY TERMS

Special price under this offer less than books bought separately. Add these standard works to your library now; pay small monthly installments, while you use the books.

SEND THIS EXAMINATION COUPON

McGraw-Hill Book Co., 330 W. 42 St., N. Y.

Send me Radio Engineering Library for 10 days' examination on approval. In 10 days I will send \$3.00 plus few cents postage, and \$3.00 monthly till \$24.00 is paid, or return books postpaid. (We pay postage on orders accompanied by remittance of first installment.)

Name.....

Address.....

City and State.....

Position.....

Company..... QST 11-41
 (Books sent on approval in U. S. and Canada only)

the batteries, making the changeover to line supply only after the rectifier is warmed up and becomes operative. This changeover is entirely automatic and is made without any break in operation.

This relay is the Amperite Type 2R-67. It consists essentially of a double-pole thermostatically-operated switch, enclosed in a standard, octal-base tube envelope. This contains a mica supporting plate on which is wound the heater wire. Supported by this plate are two fixed contacts and two moving contact arms of thermostatic bi-metal such that heat developed by the filament winding causes these arms to swing out and open the circuits.

A relay of this type is not only practical for use in new equipment design but can be readily installed in existing equipment employing battery tubes with series filaments. It will eliminate the need for the usual battery-line switch, will provide instant operation at all times and will prevent the unnecessary battery drain which results from the common error of leaving the switch in the battery position when the equipment is plugged in for line operation.

The Amperite Type R6V relay, operating on a similar principle, is designed to provide an automatic delay of 30 seconds or longer between the application of filament voltages and the application of plate voltages. The heating element in this type operates from standard 6.3-volt supply. The contacts are capable of handling up to 2.5 amperes continuously at 115 volts.

A.A.R.S. Activities

(Continued from page 51)

their availability for participation in the Aircraft Warning System activities; 30,000 are available for hire as civilians in fixed radio stations and around 17,500 desire to be considered for both Aircraft Warning Service and fixed-station work. Incidentally, only 41% are unmarried. In the matter of dependency on commercial electric power, approximately 6,900 or 17% of those returning the questionnaire have an emergency power source independent of commercial mains.

Correspondence

(Continued from page 56)

a long-dashed P and an exaggerated spacing between the A and the X, and a long-dashed X. No matter how bad the static, how weak the signal, how suffocating the QRM, you can identify the calls of these stations without mistake even though you can hear only the faintest whisper of a signal.

The most perfect practitioners of the art of swing are, or were, the crew at WNU, the TRT station at New Orleans. You could copy them for hours without tiring; their rhythm and swing were as nearly like music as a monotone could possibly be.

"Swing" is still as necessary in low-frequency marine work as it ever was. It enables the receiving operator to copy more effectively through QRN and QRM, and aids him in squeezing the last drop of intelligence from a distant signal that is just barely audible.

I'll concede the academic fact that swing is not necessary on high-frequency circuits where there is little or no static and where there is a nice, juicy signal to copy. But just because there is a little bit of die-hard left in me, I'd like to advance this idea: When an operator tires, his sending

Where to buy it

A directory of suppliers who carry in stock the products of these dependable manufacturers.



ALBANY, N. Y. Uncle Dave's Radio Shack 356 Broadway
ATLANTA, GEORGIA Radio Wire Television Inc. 265 Peachtree Street
BOMBAY, INDIA Eastern Electric & Engineering Company
BOSTON, MASS. Radio Shack 167 Washington Street
BOSTON, MASS. Radio Wire Television Inc. 110 Federal Street
BRIDGEPORT, CONN. Hatry & Young, Inc. 177 Cannon Street
BRONX, N. Y. Radio Wire Television Inc. 542 East Fordham Rd.
BUFFALO, N. Y. Dymac, Inc. 1531 Main Street
BUTLER, MISSOURI Henry Radio Shop 211-215 N. Main Street
CHICAGO, ILL. Allied Radio Corp. 833 W. Jackson Blvd.
CHICAGO, ILL. Radio Wire Television Inc. 901-911 W. Jackson Blvd.
CINCINNATI, OHIO United Radio, Inc. 1103 Vine Street
DETROIT, MICH. Radio Specialties Co. 325 E. Jefferson Ave.
DETROIT, MICHIGAN Radio Specialties Co. 11800 Woodward Ave.
HARTFORD, CONN. Radio Inspection Service Company 227 Asylum Street
HOUSTON, TEXAS R. C. & L. F. Hall 1021 Caroline Street
INDIANAPOLIS, INDIANA Van Sickle Radio Supply Co. 34 West Ohio Street
KANSAS CITY, MO. Burstein-Applebee Company 1012 McGee Street
LITTLE ROCK, ARKANSAS Beem Radio Company 409 W. 3rd Street
NEW HAVEN, CONN. Hatry & Young, Inc. 1172 Chapel Street
NEW YORK, N. Y. Harrison Radio Co. 12 West Broadway
NEW YORK, N. Y. Radio Wire Television Inc. 100 Sixth Ave.
NEWARK, N. J. Radio Wire Television Inc. 24 Central Ave.
READING, PENN. George D. Barbey Company 404 Walnut Street
SCRANTON, PENN. Scranton Radio & Television Supply Co. 519-21 Mulberry Street
WASHINGTON, D. C. Sun Radio & Service Supply Co. 938 F Street, N. W.
WATERBURY, CONN. Hatry & Young, Inc. 199 South Main Street

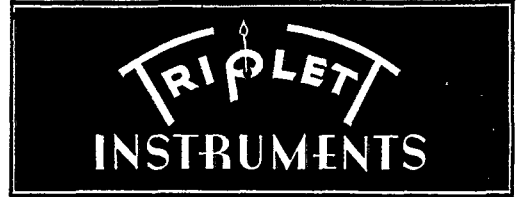

ALBANY, N. Y. Uncle Dave's Radio Shack 356 Broadway
ATLANTA, GEORGIA Radio Wire Television Inc. 265 Peachtree Street
BOSTON, MASS. Radio Shack 167 Washington Street
BOSTON, MASS. Radio Wire Television Inc. 110 Federal Street
BRIDGEPORT, CONN. Hatry & Young, Inc. 177 Cannon Street
BRONX, N. Y. Radio Wire Television Inc. 542 East Fordham Rd.
BUFFALO, N. Y. Dymac, Inc. 1531 Main Street
BUTLER, MISSOURI Henry Radio Shop 211-215 N. Main Street
CHICAGO, ILLINOIS Allied Radio Corp. 833 W. Jackson Blvd.
CHICAGO, ILL. Radio Wire Television Inc. 901-911 W. Jackson Blvd.
CINCINNATI, OHIO United Radio, Inc. 1103 Vine Street
HARTFORD, CONN. Hatry & Young, Inc. 203 Ann Street
LITTLE ROCK, ARKANSAS Beem Radio Company 409 W. 3rd Street
MINNEAPOLIS, MINNESOTA Lew Bonn Company 1211 LaSalle Avenue
NEW HAVEN, CONN. Hatry & Young, Inc. 1172 Chapel Street
NEW YORK, N. Y. Radio Wire Television Inc. 100 Sixth Avenue
NEWARK, N. J. Radio Wire Television Inc. 24 Central Ave.
READING, PENN. George D. Barbey Company 404 Walnut Street
WASHINGTON, D. C. Sun Radio & Service Supply Co. 938 F Street, N. W.

Listings on this page do not necessarily imply endorsement by QST of the dealers or of other equipment sold by them.

YOU CAN BE SURE WE HAVE IT!

Months back, visualizing the growing tendency of government restriction and allotment of material for commercial and civilian use, we placed enormous orders with our regular factory suppliers for parts and supplies of all types. At this writing, with delays and shortages paramount around us we can honestly say with great pride

"SUN DELIVERS THE GOODS"

WE CARRY ALL NATIONALLY-KNOWN PRODUCTS IN STOCK!

	AEROVOX	
AMPHENOL		ASTATIC
	AUDAK	
B & W		BLILEY
	BRUSH	
BUD		BURGESS
	CARDWELL	
CENTRALAB		CINAUDAGRAPH
	CORNELL-DUBILIER	
EBY	ECHOPHONE	EIMAC
	GAMMATRON	
G.E.		GUARDIAN
	HALLCRAFTERS	
HAMMARLUND		HICKOK
	HYTRON	
I.R.C.		JACKSON
	JENSEN	
JOHNSON		JONES
	KENYON	
MALLORY		MEISSNER
	MILLEN	
MILLER		NATIONAL
	OHMITE	
PAR-METAL		R.M.E.
	R.C.A.	
SHURE		SPEED-X
	STANCOR	
SUPREME		TAYLOR
	THORDARSON	
TRIPLETT		U.T.C.
	WESTON	

and many, many others!

JUST OUT!

**ABBOTT TR-4 2½ METER
U.H.F. TRANSMITTER-RECEIVER**

Here's a brand new emergency transmitter-receiver for mobile or fixed station use. **PRICE**—less accessories **\$38.22**

Write for full specifications

PROMPT ATTENTION GIVEN MAIL ORDERS

★ VISIT OUR "HAM" SHACK ★
OPEN DAILY 8:30 A.M. to 7:00 P.M.

Telephone: BARCLAY 7-1840

SUN RADIO CO.
212 Fulton Street, Dept. QC New York
Cable Address: SUNRADIO NEW YORK

might tend to become "fuzzy." If he has been trained to try for machine-like sending, his fist becomes erratic after he has passed the fatigue point. If he has learned to swing (properly) the fatigue point is delayed, and even after it is reached the very quality of the swing itself will continue to make good readable copy.

— C. D. Remmlin, W3AQC-W3IZD

SPORTSMANSHIP ON THE UHF

Southern Pacific Telegraph Office, Tucson, Ariz.
Editor, QST:

Do you like good sportsmanship? Do you appreciate real achievement? If so, then it's yours by the bucketful on the ultrahigh frequencies. In my 22 years of ham radio I've not met so many real sports nor have I seen such rapid improvement in radio gear as I've experienced as one of the "megacycle maniacs." Yes, there's room for more—in fact, there's room for thousands more for we speak in terms of megacycles instead of kilocycles up on the ultrahighs! Just drop in and visit one of the boys sometime. I dare you! Yes, I double dare you!

Every true American loves good sportsmanship and nowhere in ham radio will you find more of it than you will find among this gang. I've seen numerous cases during the current u.h.f. marathon which overshadowed anything I've ever experienced on the lower frequencies. These fellows think nothing of pulling the switch, right in the middle of a "big day" on 56 Mc., in order to allow the other local stations to work some rare DX station that is coming through on their own frequency. It's common practice for these boys to pass out a long list of calls and frequencies of fellow contestants to the fellows on the other end of the skip, knowing all the time that it means points ahead for several or perhaps all those named. They often quit the air right in the heat of things and call up one of the local boys on land line to get him on the air before it's too late! This is one part of the spectrum where you find fellows bringing over their home-made equipment to see if it won't beat your own and when it fails to do so you feel just as bad about it as they do! Pages could be written on the friendship that exists among these guys on the ultrahighs.

As for achievement, I'm sure that the pages of the current magazines will tell more than I could ever find time to write about. New records become old between issues. In fact, the editors open letters from one mail delivery reporting a world's record, only to find a letter in the next mail shattering all previous records!

Drop in and see one of the gang some evening. Who knows? you might witness the enactment of one of these world's records! You might see a revolutionary piece of radio equipment going through the final tests. To say the least, your host will probably throw his rig on the air and let you talk to one of ham radio's immortals, if there isn't anything real exciting under way. . . .

Has your pet band lost its zingo? Have you got the "bots" and feel like quitting it all? Then come on up where the air is clearer and where there's new life, new friends—in fact where more new things exist than you have ever seen before.

— James W. Brannin, W6OVK

Strays

Frustrated in an attempt to solder some joints with an electric iron exposed to the sea breezes at the location of W1EH/1 on Field Day, the gang huddled together and, with the aid of a few matches, succeeded in raising the temperature enough to do the job. They followed the *Handbook*, which stresses the importance of soldered joints!

WANTED

COMPETENT ELECTRONICS MECHANIC

to build experimental electronic test equipment. Must be capable of complete layout, construction and test from a schematic diagram. Engineering background desirable but not essential. Apply by letter to Installation Department. Applications not solicited from persons now employed in aircraft manufacturing industry.

Pratt and Whitney Aircraft, East Hartford, Conn.

*We can think of
Nothing finer to Own*

SX-28

FEATURES

Fifteen tubes. Two stages pre-selection. Calibrated band spread. Micrometer scale tuner. Beat frequency oscillator. AF & RF gain. Crystal phasing. Adjustable noise limiter. Send-receive switch. AVC-BFO switch. Phono jack. 10, 20, 40, 80 meter amateur band calibrator. Wide angle "S" meter. Band pass audio filter. High signal to image and a noise reacher. Push pull audio output. Six step variable selectivity.

\$179⁵⁰



TERMS

Down Payment \$44.88

Eight Monthly Payments **\$17.84**
LESS SPEAKER

**IMMEDIATE DELIVERY ON ALL HALLICRAFTER
MODELS**

YOUR OLD RECEIVER TAKEN IN TRADE

BUY ON EASY TERMS

MAIL ORDERS PROMPTLY FILLED

WRITE FOR FREE CATALOG

The RADIO SHACK
167 WASHINGTON ST., BOSTON, MASS., U.S.A.

**HE BOUGHT AN
ECHOPHONE EG-1!**

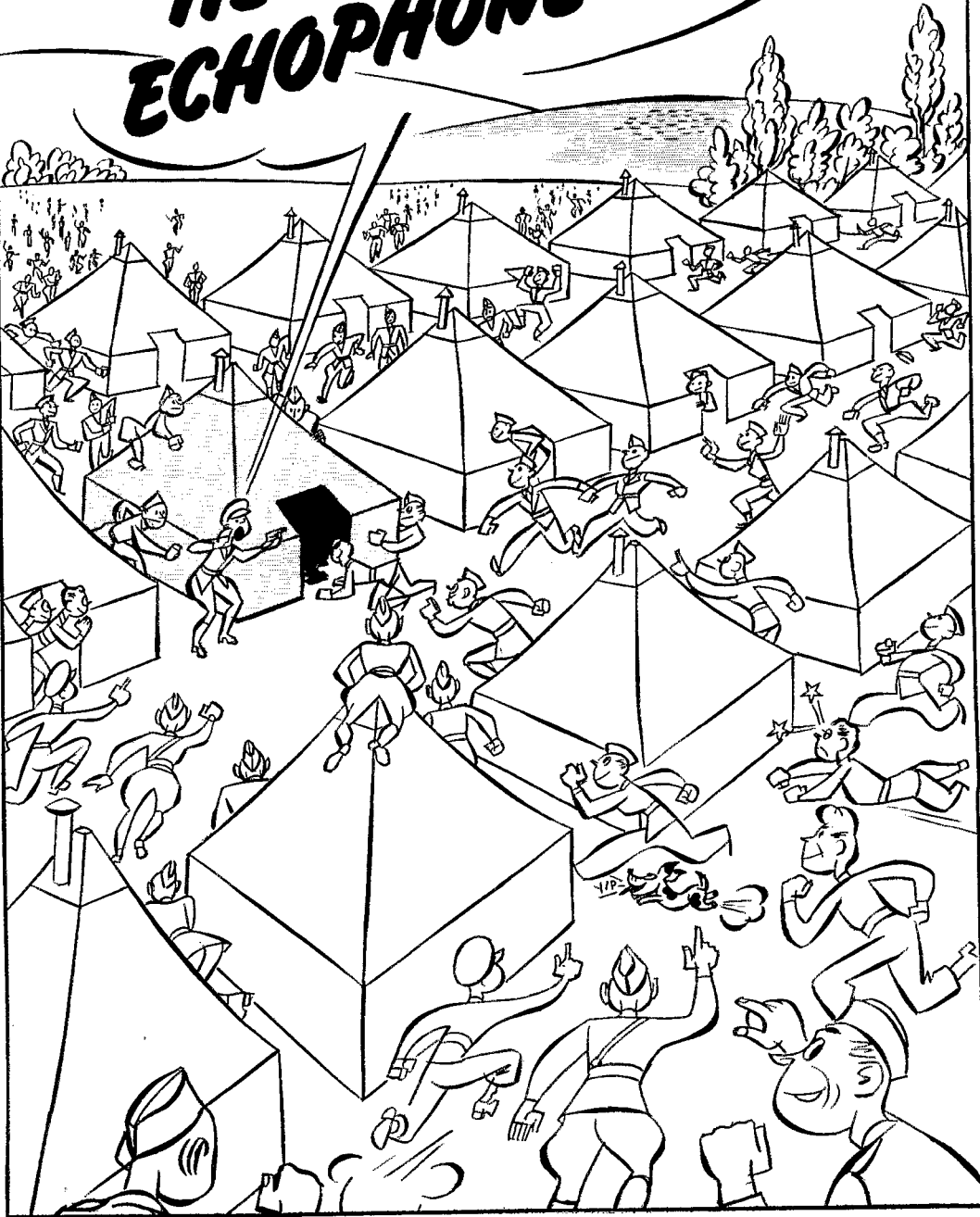

HAM-ADS

(1) Advertising shall pertain to radio and shall be of nature of interest to radio amateurs or experimenters in their pursuit of the art.

(2) No display of any character will be accepted, nor can any special typographical arrangement, such as all or part capital letters be used which would tend to make one advertisement stand out from the others.

(3) The Ham-Ad rate is 15¢ per word, except as noted in paragraph (6) below.

(4) Remittance in full must accompany copy. No cash or contract discount or agency commission will be allowed.

(5) Closing date for Ham-Ads is the 25th of the second month preceding publication date.

(6) A special rate of 7¢ per word will apply to advertising which, in our judgment, is obviously non-commercial in nature and is placed and signed by a member of the American Radio Relay League. Thus, advertising of bona fide surplus equipment owned, used and for sale by an individual or apparatus offered for exchange or advertising inquiring for special equipment, if by a member of the American Radio Relay League takes the 7¢ rate. An attempt to deal in apparatus in quantity for profit, even if by an individual, is commercial and all advertising by him takes the 15¢ rate. Provisions of paragraphs (1), (2), (4) and (5) apply to all advertising in this column regardless of which rate may apply.

Having made no investigation of the advertisers in the classified columns, the publishers of QST are unable to vouch for their integrity or for the grade or character of the products advertised

* * * * *

Gear is short. You can sell your old and extra gear through Ham-Ads.

* * * * *

QUARTZ — direct importers from Brazil of best quality pure quartz suitable for making piezo-electric crystals. Diamond Drill Carbon Co., 719 World Bldg., New York City.

QSL'S, Cartoons. Free samples. Theodore Porcher, 7708 Navajo, Philadelphia, Pa.

CALLBOOKS — Fall edition now on sale containing complete up-to-date list of radio hams throughout entire world. Single copies \$1.25. Canada and foreign \$1.35. Radio Amateur Call Book, 610 S. Dearborn, Chicago.

QSL'S — SWL's 100 — 3 color — 75¢. Lapco, 344 W. 39th, Indianapolis, Ind.

COMMERCIAL radio operators examination questions and answers. One dollar per element. G. C. Waller, W5ATV, 6540 Washington Blvd., Tulsa, Okla.

QSL'S — Brownie, W3CJL, 1725 Frankensfeld Ave., Allentown, Pa.

TELEPLEXES, Instructographs bought, sold. Ryan's, Hannibal, Mo.

WANTED: Collins transmitter — give model; price must be reasonable. W9SFD.

SELL Super Defiant receiver, good condition, \$80. J. L. Mundy, 23rd Street YMCA, N. Y. C.

QSL'S. Finest. Samples. Maleco, 1805 St. Johns Place, Brooklyn, N. Y.

LATEST Collins 32-G all-band transmitter, beautiful job, factory-new condition, complete, tubes, crystal, ten-twenty meter coils, built-in oscilloscope, antenna changeover relay. Cost \$325, sell \$175 cash. W9RGE.

MODERN 600 watt, phone — CW, break-in transmitter, complete unit. Best offer. W2MUG.

QSL samples, prices on request. W2AEY, 338 Elmora, Elizabeth, N. J.

WANTED — four good RCA-211's or equal. Will pay \$5 each. W1BB.

WANTED: Gasoline driven electric generator; good condition. 500 — 1000 watt capacity; 110 volt 60 cycle. Cash or exchange. W9SYD.

SELL: Biley 100 — 1000 kc. unit. W8KJ.

COLLINS 30FXC 10, 20, 80 coils \$300; X-EC \$35; HRO \$125; Precision 842L \$12. W9NHF.

QSL'S & SWL's — Fritz, 1213 Briargate, Joliet, Ill.

OLD QSTs. Bought — sold — traded. 1916/41. W6SN.

600 watt fone, 750 CW transmitter, rack and panel, \$325, 50 wfd, Hammarlund variable 0,500 volts, 500 MA Kenyon choke. W9PPB, YMCA, Kokomo, Ind.

HALLICRAFTERS SX17 and speaker \$80. W2TG, Brizzolari, 68-60 108th St., Forest Hills, N. Y.

QSL'S7 — SWL's? — Biley crystals? Patronize the ham. Samples. W8DED, Holland, Mich.

SELL — Hallicrafters SX25 used few months, \$74.50 cash. Kenneth Bailey, 420 Madison St., Gary, Ind.

W9IET selling — 140 watt phone \$75, 200 watt CW xmitter \$40, Channel analyzer and Rider Manuals. 714 Newbury St., Ripon, Wis.

FOLLOW the crowd to 2½ with a bang. 10 D.B. gain gives your signal that extra wallop. 21 element square corner beam gives more signal per dollar. Shipped complete \$12 COD. High Frequency Engineering Co., Lorain, Ohio.

MUST sell complete kilowatt station Skyrider SX-17. Henry Anderson, Pelican Rapids, Minn.

HENRY Radio Shop has a new branch store at 2335 Westwood Blvd., West Los Angeles, California. Let's get acquainted. Your inquiries invited.

BOB Henry, W9ARA, has NC-200s, HQ-120Xs, SX-28s, SX-28s, SX-32s, S-29s and world's largest stock of all makes and models amateur receivers and parts for immediate delivery at lowest prices. He offers you more and better deal always. Best terms (financed by ourselves); largest trade-in; free trial; personal cooperation; 100% satisfaction. Write, telegraph, telephone. Henry Radio Shop, Butler, Mo.

RECONDITIONED guaranteed amateur receivers and transmitters. All makes and models cheap. Free trial. Terms. List free. Write. W9ARA, Butler, Mo.

SELL — complete station — Meissner Duluxe shifter — 814 — T-55s final in steel cabinet. National 101X revr. 7 meters including ant. Many extras. Cost over \$1000 — sell at 25% of cost. W9NSI, Fred C. Martens, 1023 Wolfram St., Chicago, Ill.

WANTED — transmitter for phone and CW about 100 watts, all bands. Lowest price. W20BH.

TRADE for ham receiver of equivalent value Retina II camera F2; cost \$140 new. Hollingsworth, 2313 Turner Ave., Schenectady, N. Y.

QSL'S. Free samples. Printer, Corwith, Iowa.

SELL SX-28 with bass reflex speaker. E. M. Gettys, Decatur, Texas.

MONITORS: Keying, phone. Inexpensive, Guaranteed. W2BCP.

SELL transmitter — phone CW Stancor 100 watt cathode modulated factory wired, cabinet tubes and 10 meter coils and crystal. \$55 f.o.b. Lima. W8JFS, 712 State St., Lima, Ohio.

MUST sell file of QST '21 to '40; singly or lots. W9YUX.

WANT 3 oscilloscope. State condition, price. Wayne Nelson, Box 567, High Point, N. C.

FIRST offer of \$45 takes my NC8OX, with matched speaker. Practically new — W2LUU, Francis J. Converse, 231 Crown St., Brooklyn, N. Y.

FOR SALE — The late W7BXX's Howard 460 revr, 50-watt phone-CW xmtr, Supreme multimeter, and misc. parts. W7DSQ, St. Ignatius, Mont.

METER and instrument repair and recalibration. Lowest cost consistent with good results. Braden Engineering Co., 3317 Kenmore, Dayton, Ohio.

SELL — complete transmitter, 50 watt Browning type ECO bandswitching 10 to 160 meters, Stancor 525 modulator, Shure 708A mike. Also Hallicrafter SX-24 receiver. W2NGK, 1770 East 32 St., Brooklyn, N. Y.

RME-69 — A-1 condition — \$70. Am called into Navy. B. Wambsgans, Smithtown Branch, N. Y.

CRYSTALS: commercial or amateur. Buy them while they're still available. Eidson commercial crystal units meet FCC requirements and complete satisfaction is guaranteed. Aircraft, police, marine, defense projects, etc. A complete line is available — send for folder or get our bid. For the amateur: those dependable 19 40 and 80 meter crystals still priced at only \$1.60. 19 40 and 80 meter spot frequency crystals \$2.50 or \$3.60 with holder. Order from Eidson's, Temple, Texas, or dealers previously listed.

WANTED — old spark equipment such as transformers, quenched gaps, mica condensers, etc., also good receivers DB-20, mercury arc, synchronous and dry disc type rectifiers. W5KD, 215 N. W. 19 St., Oklahoma City.

SELL 250 watt xmtr CW. Best offer takes it. Also extra gear. W2IMV, 1074 Willmohr St., Brooklyn, N. Y.

WANTED — to contact all amateurs or others who have swapped radio apparatus with me since 1932. Please write me. Carroll Taafe, W4APE, Winter Haven, Fla.

W.E. 276As \$7 pair, RK47 \$7, like new; 4 band exciter \$10; x'tals; power supply parts. W1GEX, Box 188, Westwood, Mass.

★ *It's* **HARRISON** *for*

Echophone
COMMERCIAL

and **SERVICE!**

"The Ears of the World"

PRICES?

No matter what happens to prices — here at Harrison our large scale purchasing and our tremendous stock enable us to continue to give you the lowest possible prices at all times.

It pays to buy from Harrison!

★
DELIVERY?

With production facilities already greatly over-taxed, deliveries are falling behind more every day. But, we anticipated this "Back-order Era" and placed protective orders many months ahead. Right now we have more receivers, parts, tubes, etc. *on hand* than at any time in our sixteen year history!

You get faster delivery from Harrison!

MODEL EC-1

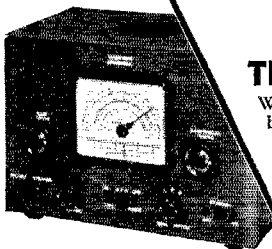

A six tube, AC-DC, communications receiver whose "hop" will amaze you! 550 Kc to 30 Mc in three bands, electrical band-spread, BFO, self-contained dynamic speaker — Safety headphone jack, etc. A "knock out value" at only \$24.50, complete!

Harrison has it — in stock!

NEW EC-2

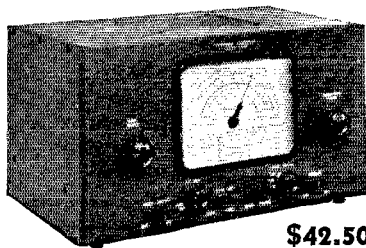

\$42.50

Here's the new and improved version of this popular set. Now with an external speaker (just like EC-3). Automatic noise limiter, preselection on all bands, calibrated band-spread, AC-DC, safety headphone jack, 8 tubes, 595 Kc to 60 Mc. Bigger value than ever at only \$42.50, complete with speaker in matching cabinet.

Harrison has it — in stock!

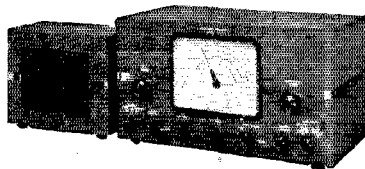

MODEL EC-3

10 tubes, 545 Kc to 30.5 Mc, preselection and electrical band-spread on all bands, calibrated Amateur band-spread, variable selectivity crystal filter, automatic noise limiter, two IF stages, dynamic speaker in matching cabinet, AC-DC, safety phone jack, etc. You'll like the "top-notch" performance of this swell communications receiver! Get yours *today* for only \$59.50, complete with speaker.

Harrison has it — in stock!

★
TRIAL?

When you buy anything from Harrison it has to be entirely satisfactory or you don't keep it. Try out your next receiver for ten days without charge or obligation by ordering it from us.

You get 100% cooperation from Harrison!

★
TRADE-IN?

By fair dealing we have built up the largest Reconditioned Receiver business in the world! We have a ready market for your old set, and that means we can give you the very best trade-in allowance. (We also buy receivers, transmitters, etc., for cash.)

You get the best deal at Harrison!

★
TERMS?

Certainly! Charge Account or Easy Payment Plan. Buy your Receiver, transmitter, parts, etc., on our easier terms at lowest cost.

Your credit is good at Harrison!

★
GUARANTEE?

Everything is "guaranteed," but your best guarantee is the integrity of the person with whom you deal. Here at Harrison we go far beyond the standard warranty in order to please you!

You get a square deal from Harrison!

★
I'll be looking for your order!

73,
BILL HARRISON, W2AVA

★
For anything you need — Write to me — NOW!

★
★
★
★
★
★
★
★
★
★
HARRISON RADIO CO.

12 WEST BROADWAY • NEW YORK CITY

Worth 2-6276

Your Nearby Dealer Is Your Best Friend

Your nearby dealer is entitled to your patronage. He is equipped with a knowledge and understanding of amateur radio. He is your logical source of advice and counsel on what equipment you should buy. His stock is complete. He can supply your needs without delay. His prices are fair and consistent with the high quality of the goods he carries. He is responsible to you and interested in you.

One of these dealers is probably in your city — Patronize him!

ATLANTA, GEORGIA

Radio Wire Television Inc.
265 Peachtree Street
"The World's Largest Radio Supply House"

HOUSTON, TEXAS

R. C. & L. F. Hall
1021 Caroline Street (C 0721)
"Specialists in Amateur Supplies"

BALTIMORE, MARYLAND

Radio Electric Service Co.
3 N. Howard St.
Everything for the Amateur

NEWARK, N. J.

Radio Wire Television Inc.
24 Central Avenue
"The World's Largest Radio Supply House"

BOSTON, MASS.

Radio Wire Television Inc.
110 Federal Street
"The World's Largest Radio Supply House"

NEW YORK, N. Y.

Radio Wire Television Inc.
100 Sixth Avenue
"The World's Largest Radio Supply House"

BUFFALO, NEW YORK

Radio Equipment Corp.
326 Elm Street
W8PMC and W8NEL — Ham service and sound equipment

NEW YORK, N. Y.

Harrison Radio Company
12 West Broadway
Harrison Has It! Phone WOrth 2-6276 for information or rush service

BUFFALO, NEW YORK

Dymac, Inc.
1531 Main Street — Cor. Ferry — GA. 0252
One of the Largest Ham Supply Houses in Western New York

PHILADELPHIA, PENNSYLVANIA

Eugene G. Wile
10 S. Tenth Street
Complete Stock of Quality Merchandise

HARTFORD, CONNECTICUT

Radio Inspection Service Company
227 Asylum Street
What do you want? We have it. Radio exclusively

PROVIDENCE, RHODE ISLAND

W. H. Edwards Company
85 Broadway
National, Hammarlund, Hallicrafter, Thordarson, Taylor, RCA

HARTFORD, CONNECTICUT

Hatry & Young, Inc.
203 Ann Street
Stores also in Bridgeport and New Haven

SCRANTON, PENNSYLVANIA

Scranton Radio & Television Supply Co.
519-521 Mulberry Street
Complete Stock of Quality Amateur Supplies

WATERBURY, CONNECTICUT

Hatry & Young, Inc.
199 South Main Street
Time Payments for Connecticut Hams

YOU CAN BE SURE
WHEN YOU BUY FROM

QST

ADVERTISERS

“Advertising for *QST* is accepted only from firms who, in the publisher’s opinion, are of established integrity and whose products secure the approval of the technical staff of the American Radio Relay League.”

Quoted from QST’s advertising rate card.

Every conceivable need of a radio amateur can be supplied by the advertisers in QST. And you will know the product has the approval of the League’s technical staff

Index to Advertisers

	PAGE
Abbott Instrument, Inc.	97
Aerovox Corporation	82
American Lava Corporation	95
American Radio Institute	98
Amperex Electronic Products, Inc.	Cov. 2
Astatic Corporation, The	99
Ayers, N. C.	98
Biley Electric Company	64
Candler System Company	80
Capitol Radio Engineering Institute	74
Cardwell Mfg. Corp., Allen D.	68
Centralab	79
Commercial Radio Institute	98
Daven Company, The	84
Dodge Institute, The	99
Echophone Radio Company	106
Eitel-McCullough, Inc.	77
Gardiner-Levering Company	78
General Electric Company	69
Hallcrafters Company, The	1, 2
Hammarlund Mfg. Company, Inc.	63, 65
Harrison Radio Company	108
Harvey Radio Company	96
Harvey Radio Laboratories	90
Henry Radio Shop	111
Hipower Crystal Company	78
Howard Radio Company	91
Instructograph Company	97
International Resistance Company	81
Jacobs, Charles F.	90
Jensen Radio Mfg. Company	5
Johnson Company, E. F.	83
Kenyon Transformer Company, Inc.	101
Mallory & Company, Inc., P. R.	62
Massachusetts Radio School	99
McGraw-Hill Book Company, Inc.	102
Melsner Mfg. Company	70
Midland Radio & Television Schools, Inc.	101
Millen Mfg. Company, Inc., James	86
National Company, Inc.	Cov. 3, 61, 73
New York YMCA Schools, Inc.	99
Newark Electric Company	71
Nilson Radio School	90, 99
Ohmite Mfg. Company	87
Par-Metal Products Corp.	86
Petersen Radio Company	97
Port Arthur College	78
Pratt and Whitney Aircraft	104
Precision Apparatus Company	99
RCA Institutes, Inc.	98
RCA Mfg. Company, Inc.	Cov. 4
Radio City Products Company, Inc.	82
Radio Control Headquarters, Inc.	90
Radio Shack, The	105
Sickles Company, F. W.	97
Signal Electric Mfg. Company	80
Solar Mfg. Corporation	72
Speer Carbon Company	75
Standard Radio Parts Company	96
Standard Transformer Corp.	94
Sun Radio Company	104
Taylor Tubes, Inc.	85
Teleplex Company	84
Terminal Radio Corp.	100
Thordarson Electric Mfg. Company	76
Triplett Elec. Instr. Company, The	98
United Transformer Corp.	112
Ward Leonard Electric Company	90
Wholesale Radio Laboratories	100

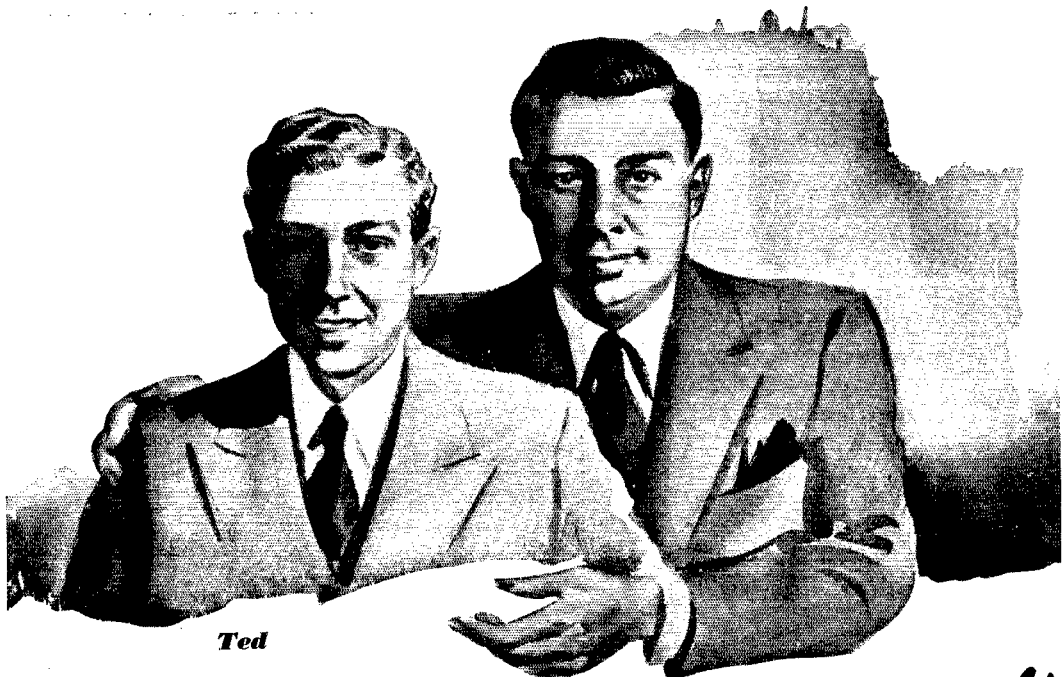

Ted

Bob

Henry Goes Hollywood!

BETTER SERVICE FOR OUR WESTERN FRIENDS

In order to give better service to my ever increasing list of western customers, I have opened a completely stocked branch in Los Angeles. My brother Ted is in charge — drop him a line, or stop in and see him. There are many good reasons for our increasing sales of Amateur Receivers. Each order receives our personal attention, a service you cannot get elsewhere. You get IMMEDIATE SHIPMENTS from the WORLD'S LARGEST STOCK of all makes and models of Amateur Communication Receivers. We finance our own time payment sales — no red tape — and less cost to you, easy 6% terms. We can afford to give you better trade-in — send us a description of your old receiver.

Remember, you don't buy unless you are satisfied and you get a 10 DAY FREE TRIAL!

**New Branch Address: HENRY RADIO SHOP
2335 Westwood Blvd., West Los Angeles, Calif.**

"WORLD'S LARGEST DISTRIBUTOR
OF AMATEUR RECEIVERS"

Bob Henry
W9ARA
HENRY RADIO SHOP
BUTLER, MISSOURI

Ready For Anything

Whether you are interested in Industrial Rectifiers from 1 volt to 250,000 volts and from 1 Ma. to 2500 Amps . . .

Or if you are interested in small transformers in our Ultra-Compact Ouncer or Sub-Ouncer types (our smallest units weigh only one-third ounce) . . .

Or if you require high power transformer equipment for a 500 Kw. transmitter . . .

Or an industrial application or a special Varitran or Voltage Regulator to suit a specific requirement . . .

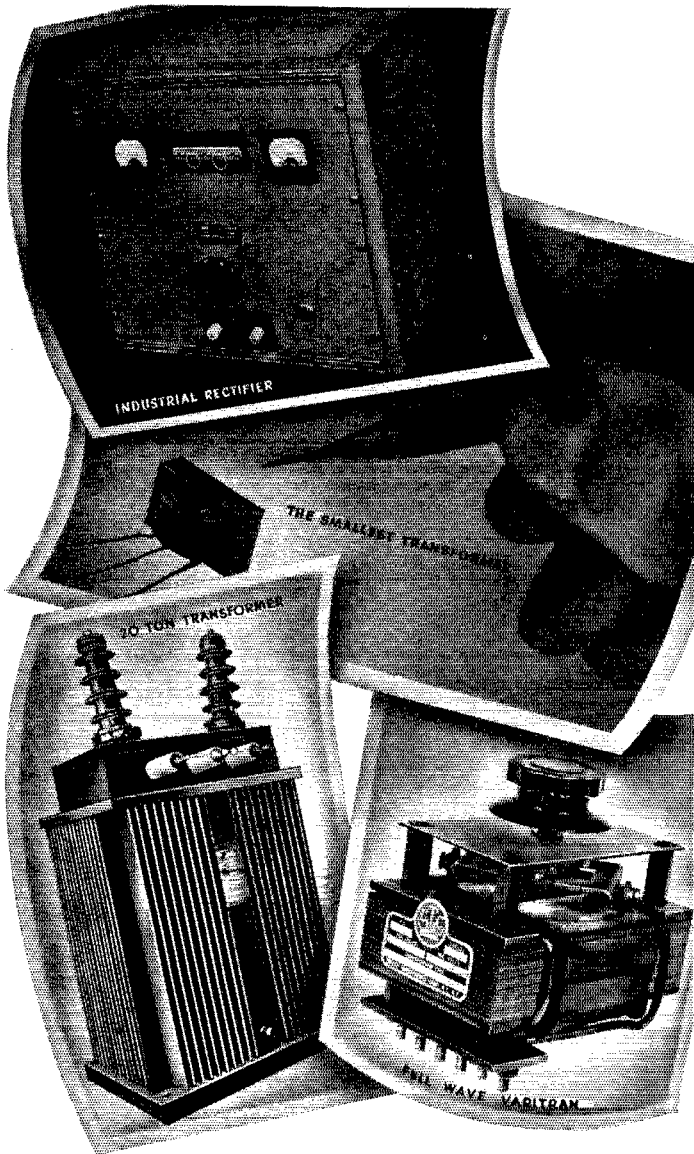

*Is the Choice of
Leaders of Industry*

MAY WE ASSIST YOU IN YOUR PROBLEM?
A note to our Engineering Division will bring a quick response with details on units to your requirements.

UNITED TRANSFORMER CORP.

Write: COMMUNICATIONS DIV. ★ 150 VARICK ST. ★ NEW YORK, N. Y.
EXPORT DIVISION: 100 VARICK STREET NEW YORK, N. Y. CABLES: "ARLAB"



THE NC-45

*A Superb Receiver at
Moderate Price*

Series valve noise limiter
with automatic threshold
control

Improved AVC circuit

Eight tube superheterodyne
circuit

Full vision dial with sep-
arate bandsread condenser

Tone control

CW Oscillator

Four range coil switch, 550
KC to 30 MC

Three models; for batteries,
for AC-DC, and for AC only

Amateur Net Price \$57.50

including speaker and tubes

THE NC-200

*The Outstanding Amateur
Receiver*

Sensitivity better than one
microvolt

Series valve noise limiter

Improved crystal filter with
rejection ratios as high as
10,000 to 1

Stability 3 parts in 100,000
for 20 volt line fluctuation

AC or portable operation

Tone control

CW oscillator

Speaker in matching cabinet

Amateur Net Price \$159.50

without speaker

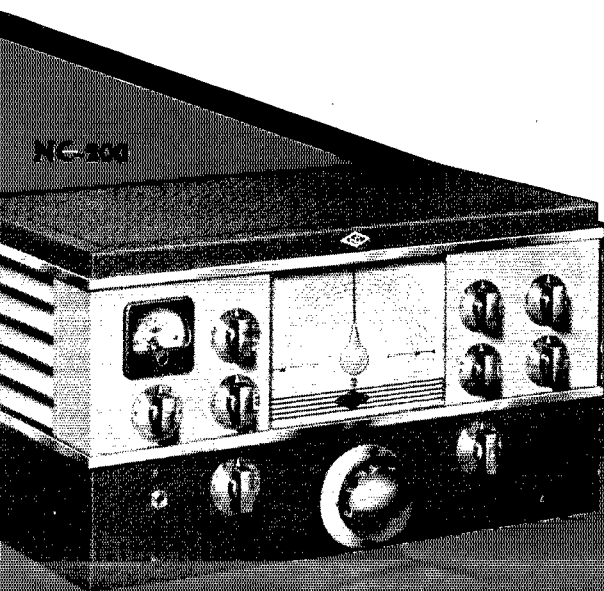

NATIONAL COMPANY, INC.
MALDEN, MASS.

They're Making TUBE HISTORY!

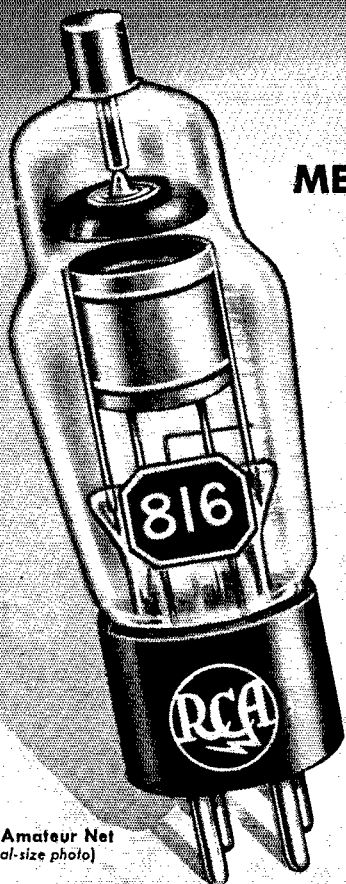

RCA-816 HALF-WAVE MERCURY-VAPOR RECTIFIER "JUNIOR OF THE 866-A/866"

5000 VOLTS • 0.5 AMPERE

PEAK INVERSE VOLTAGE PEAK PLATE CURRENT

The RCA-816 is the biggest little rectifier tube value RCA has ever offered—and that means a whale of a lot to those familiar with such outstanding developments of a few years ago as the 866-A and, still later, the famous 866-A/866. Designed for medium-power transmitters, the RCA-816 gives you plenty of rectified voltage at minimum cost. It's big enough by way of performance for any rig up to, say, 400 watts input—and it is physically small enough to fit in almost anywhere. Two RCA-816's in a full-wave circuit can deliver 1600 rectified volts at 250 ma.—at a total rectifier tube cost of only \$2!

\$1.00 Amateur Net
(Actual-size photo)

The NEW UHF MIDGETS

Real ECONOMY for UHF Applications

Similar to the well-known Acorn types, but considerably lower in price, these new UHF Midgets open a wide range of design and engineering possibilities to the amateur who likes to keep up with the times. You'll find them particularly applicable for use with high-efficiency, high-gain circuits at unusually high frequencies. They have glass-button stems which provide short leads and low lead inductance. Because of their small size and convenient button-type 7-pin base, they require an absolute minimum of space—and you can connect them in long-life and easy-to-replace circuits.

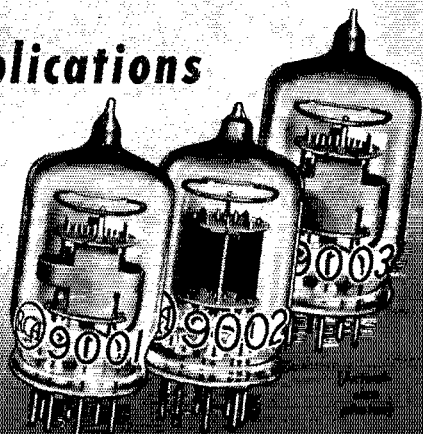

Transmitting Tubes

PROVED IN COMMUNICATION'S MOST EXACTING APPLICATIONS

RCA MANUFACTURING CO., Inc., Camden, N. J. • A Service of The Radio Corporation of America

For Canadian prices write to RCA Victor Company Limited, Montreal

